



OPHTHALMIC INSTRUMENTS + IOLs & Consumables 2023



**AFFORDABLE.
RELIABLE. PRECISE.**

INTRODUCTION	8-10
IOLs, DISPOSABLE ANTERIOR INSTRUMENTS, AND CONSUMABLES	11-28
NEW	29-34
REUSABLE ANTERIOR INSTRUMENTS	35-129
VITREORETINAL INSTRUMENTS AND CONSUMABLES	131-151
FEATURED SETS	153-174
APPENDIXES	175-212

INTRODUCTION

MORE THAN 25 YEARS OF SUCCESS	8
HOW TO PLACE AN ORDER	9
WARRANTY, RETURNS AND REPLACEMENTS	9

IOLS, DISPOSABLE ANTERIOR INSTRUMENTS, AND CONSUMABLES

IOL IMPLANTATION SOLUTIONS	12
IOLs	13
Hydrophobic	13
Hydrophilic	14
DISPOSABLE INJECTION SYSTEMS AND CARTRIDGES	15
OVDs	16
Dispersive	16
Cohesive	17
DISPOSABLE KNIVES	18
Side-Port Knives	18
Paracentesis Knives	18
Slit Knives	18
Trapezoidal Knives	18
Clear Corneal Knives	19
Clear Corneal Knives with Depth Indicators	19
Crescent Knives	19
Pre-Set Knives	19
MVR Knives	19
DISPOSABLE INSTRUMENTS	20
Speculums	20
Spatulas and Manipulators	20
Forceps	21
Scissors	21
Set of I/A Handpieces	22
Iris Retractors	22
PVA Spears	22
MANI OPHTHALMIC SUTURES	23
DISPOSABLE CANNULAS	24
Anesthesia Cannulas	25
Anterior Chamber Cannulas	25
Hydrodissection Cannulas	26
Cystotome Cannulas	26
Refractive Cannulas	26
Lacrimal Cannulas and Sets	27

NEW

REUSABLE ANTERIOR INSTRUMENTS

BLADE HOLDERS	36
CALIPERS & GAUGES	37
Calipers & Keratometers	37
Gauges	38
MARKERS	39
Axis Markers	39
Capsulorhexis Markers	39

Corneal Transplant Markers	39
Optical Zone Markers	40
Tunnel Markers	41
Lasik Markers	41
Toric IOL Markers	41
LRI Markers	42
LRI/Toric Markers with Gravity Weight System	42
Marking Pens	44
A VARIETY OF CAPSULORHEXIS FORCEPS	45
FORCEPS	47
Capsulorhexis Forceps	47
Cross-Action Capsulorhexis Forceps	50
MICS Capsulorhexis Forceps	52
Forceps for Laser-Assisted Surgery	53
Cilia Forceps	54
Conjunctiva Forceps	54
Lid and Chalasion Forceps	54
Compressing Lid Forceps	55
LASIK Flap Forceps	55
SMILE Forceps	56
ICRS Forceps	57
Corneal Forceps	57
Corneal Transplantation Forceps	59
Dressing Forceps	60
Fixation Forceps	61
Lens Inserters	62
IOL Removing Instruments	63
ICL Forceps	65
Iris Forceps	66
Jeweler Forceps	66
Hemostatic Forceps and Serrefines	67
Muscle Forceps	67
Suturing Forceps	68
Tying Forceps	69
Utility Forceps	70
Towel Clamps and Forceps	70
HOOKS	71
Intraocular Lens Hooks	71
Muscle/Tenotomy Hooks	72
Retinal Detachment Hooks	73
Iris Hooks	73
DIAMOND KNIVES	74
Astigmatic Keratotomy and ICRS	74
Universal Side-Port Knives	74
Angled Phaco Knives	75
LRI Knives	76
SAPPHIRE KNIVES	77
Universal Side-Port Knives	77
Phaco Knives	77
PHACO INSTRUMENTS	78
Prechoppers	79
Choppers	80
Hydrochoppers	84
Capsule Polishers	84
Irrigation/Aspiration Handpieces	85

NEEDLE HOLDERS	87
Kalt Needle Holders	87
Castroviejo Needle Holder	87
Ing's Needle Holders/Scissors	87
Coaxial/Intraocular Needle Holders	87
Barraquer Needle Holder	88
PROBES	89
RETRACTORS	90
Lacrimal Sac Retractors	90
Lid & Orbital Retractors	90
Iris (Pupil) Dilators	91
SCISSORS	92
Corneal Scissors	92
Iris Scissors	93
Stitch Scissors	94
Strabismus Scissors	94
Tenotomy Scissors	95
Capsulotomy Scissors	96
Enucleation Scissors	97
IOL Cutters/Scissors	97
SPATULAS	98
Iris/Nucleus Spatulas	98
Cyclodialysis Spatulas	98
Femtosecond Cataract Spatulas	99
Corneal Spatulas	99
DSEK, DSAEK, DMEK Spatulas	100
DLEK Spatulas	103
DALK Spatulas	103
Foreign Body Spuds	104
PRK/LASIK Spatulas	104
LASEK Spatulas	105
SMILE Spatulas	105
FemtoLASIK Spatulas	106
ICL™ Spatulas	107
ICRS Spatulas	107
SPECULUMS	108
Speculums with Aspiration	108
Lancaster Speculums	109
Castroviejo Speculums	109
Reversible Speculums Kershner Style	109
Temporal Speculums Lieberman Style	110
Temporal Femto Speculums	110
Sauer Speculums	110
Nasal Speculums Lieberman Style	111
Barraquer Wire Speculums	112
CANNULAS	113
Anesthesia Cannulas	113
Anterior Chamber Cannulas	113
Irrigating/Aspirating Cannulas	114
Lens Removal/Nucleus Removal Cannulas	115
Hydrodissection/Hydrodelineation Cannulas	115
Cortex Removal Cannulas	116
Cystotome Cannulas	116
Capsule Polishers	116
Glaucoma Cannulas	117

DALK Cannulas	117
Refractive Cannulas	117
Lacrimal Cannulas	118
Accessories	118
MISCELLANEOUS	119
ALGERBRUSH INSTRUMENTS	119
DISPOSABLE ELECTRIC EYE CAUTERIES	120
FIXATION RINGS	120
FLIERINGA RINGS	120
INJECTORS	120
LENS LOOPS	121
LID PLATES	121
PUNCHES & RONGEURS	121
SCLERAL DEPRESSORS	122
SPOONS & CURETTES	122
SURGICAL MALLETS & CHISELS	123
NASAL SPECULUMS	123
TRABECULOTOMES	123
TREPHINES	123
TUNNEL MAKERS	123
PERIOSTEAL ELEVATORS	123
STERILIZATION TRAYS	124
SIZE CHART	124
PLASTIC TRAYS	125
ALUMINUM TRAYS	126
STAINLESS STEEL TRAYS	126
LASEK/LASIK INSTRUMENTS	127
SPATULAS	127
EPITHELIUM REMOVAL KNIVES	129
TREPHINES AND FUNNELS	129
MARKING PENS	129

VITREORETINAL INSTRUMENTS AND CONSUMABLES

A VARIETY OF OPTIONS FOR VITREORETINAL SURGERY	132
FEATURED PRODUCTS	133
VITREORETINAL INSTRUMENT TIPS	134
HANDLES FOR VITREORETINAL INSTRUMENTS	135
SCISSORS	136
INTERNAL LIMITING MEMBRANE (ILM) FORCEPS	137
EPIRETINAL FORCEPS	138
PICK FORCEPS	139
FOREIGN BODY REMOVAL FORCEPS	139
MEMBRANE INSTRUMENTS	140
23 GAUGE INSTRUMENTS	141
25 GAUGE INSTRUMENTS	142
27 GAUGE INSTRUMENTS	142
ONE-PIECE VITREORETINAL INSTRUMENTS WITH FLUSHING SYSTEM	143
REUSABLE TWO STEP TROCAR SYSTEMS	144
DISPOSABLE ONE-PIECE STAINLESS STEEL INSTRUMENTS	145
DISPOSABLE INSTRUMENTS WITH PLASTIC HANDLE	146
DISPOSABLE DIAMOND DUSTED RETRACTABLE ILM ELEVATORS	146
DISPOSABLE ONE STEP TROCAR SYSTEMS	147
DISPOSABLE BACKFLUSH INSTRUMENTS	148
BACKFLUSH HANDLES AND RESERVOIRS	148

VITREORETINAL CANNULAS	149
SILICONE OIL 1000\5000	150
SILICONE OIL INFUSION SYSTEMS	151

FEATURED SETS

CATARACT	154
REFRACTIVE	158
CORNEAL	161
GLAUCOMA	164
PTERYGIUM	165
CHALAZION	166
LACRIMAL	167
LID	168
MUSCLE	169
OCULOPLASTIC	170
VITREORETINAL	172

APPENDIXES

STERILIZATION AND CARE	176
General Instructions for Care, Cleaning and Sterilization	176
Handling of Diamond Knives	182
Handling of Vitreoretinal and Microincisional Instruments	186
ABBREVIATIONS	190
INDEX	191
CERTIFICATES	212

MORE THAN 25 YEARS OF SUCCESS

- 1990 — business started in Venezuela, Colombia
- 1994 — **RUMEX International Company was founded in Florida, USA**
- 1995 — RUMEX trademark was registered
- 1997 — distribution business started
- 2000s — fast assortment development of reusable instruments
- 2007 — product portfolio was expanded by single-use products
- 2009 — RUMEX web store started working in USA
- 2009 — launch of RUMEX single-use products manufacturing in UK
- 2010s — sales development outside Americas
- 2015 — the 1st contract exceeding 1 million dollars was signed and fulfilled
- 2016-now — fast development of single-use product portfolio

DOCTORS IN MORE THAN 100 COUNTRIES CHOOSE RUMEX

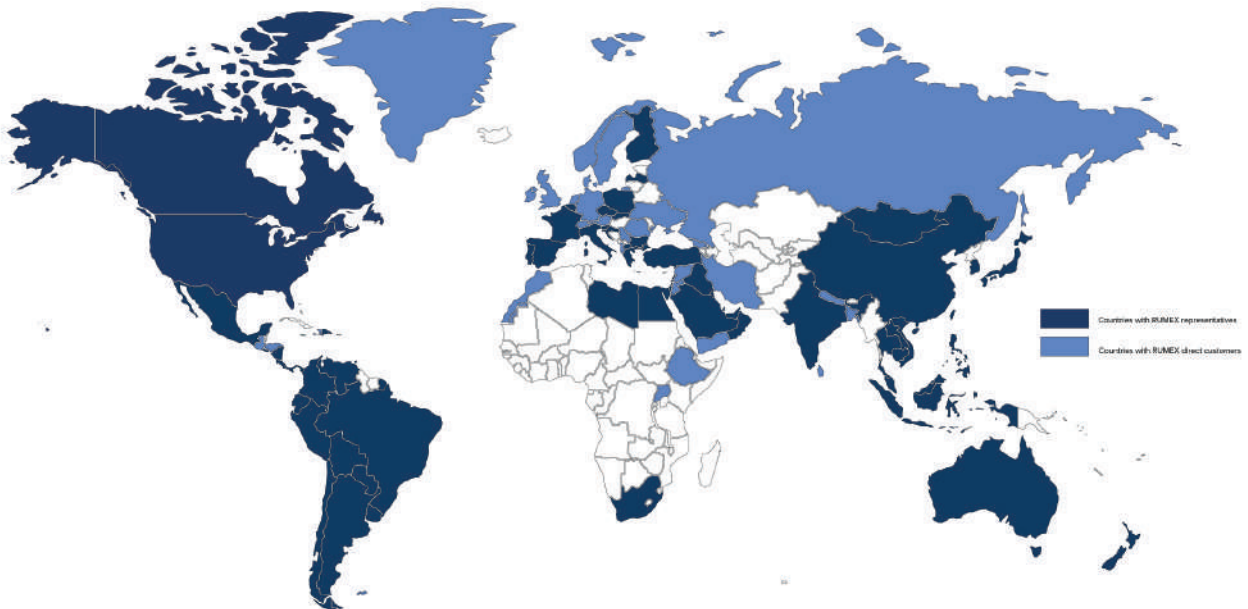

Over **2000** products
in RUMEX range

HOW TO PLACE AN ORDER

All the orders can be easily placed and paid online according to your shipping location directly via one of RUMEX online stores or through your local RUMEX representatives.

If your shipping country is USA, you are welcome to order at rumex.us

If your shipping country is within Europe, please visit rumex.eu to make your order.

For other regions visit rumex.com and find your local RUMEX representative.

Pricing

The prices are detected automatically by your location. The pricing policy may vary from region to region. Please contact your local distributor for the current prices.

Shipping

We provide our retail customers with two delivery options: via local distributor or by direct shipment from our warehouses. Purchasing with our company is simple and convenient. Processing orders quickly and efficiently is a matter of primary importance to us!

WARRANTY, RETURNS AND REPLACEMENTS

Warranty conditions

For all instruments RUMEX provides a lifetime warranty against any manufacturing or material defects. After carrying out a due expert analysis, if the defect was not caused by the improper handling or misuse, we will provide you either a 100% compensation or a free of charge exchange of a defective instrument for a new one. In some cases when instruments are improperly used or mishandled this may lead to occurrence of non-manufacturing defects, which are not covered by RUMEX lifetime warranty. To avoid such cases please read carefully and always follow our Sterilization and Care instructions or consult our customer service for proper handling Instructions.

Returns and replacements

Please check the products immediately upon the receipt, all claims (related to product appearance, count, package, etc.) shall be accepted within 10 business days after the delivery. Products that passed through the income inspection can be returned within 30 days at no charge being in the original undamaged condition. Any instrument returned within 30–60 days after shipment is subject to 10% restocking charge. No returns are accepted after 60 days.

To return or replace an instrument please fill in the RMA form and send the paper copy by post together with the instrument. To get the RMA form, please contact customer service department.

To obtain a Return Authorization Number prior to returning instruments, please call customer service department +1 727 535 9600 (for USA, Canada) +371 6616 3182 (for Europe, Asia, Africa, Latin America).

All used instruments are to be properly cleaned and sterilized before returning and shipping. Customers will be credited the costs of the instruments but will be responsible for all freight charges for the original order. Refunds are available only in a form of a credit towards future purchases. Disposable (sterile) products, instruments damaged beyond repair and custom orders are not subject to return or replacement.

Repairs

If you require a repair of an instrument, we will be glad to offer you this service at a reasonable price. Please contact RUMEX customer service team for details.

POPULAR

SKU preferred by the majority of customers

NEW

Recently introduced into the product range of RUMEX International Co.



Disposable instruments



Available in a single-use edition



Available in Stainless Steel



Featured instrument in the set on page 100

**DON'T FORGET
TO BUY**

Frequently bought together



Quantity in the box

IOLs, DISPOSABLE INSTRUMENTS, AND CONSUMABLES

IOL IMPLANTATION SOLUTIONS	12
IOLs	13
DISPOSABLE INJECTION SYSTEMS AND CARTRIDGES	15
OVDs	16
DISPOSABLE KNIVES	18
DISPOSABLE INSTRUMENTS	20
MANI OPHTHALMIC SUTURES	23
DISPOSABLE CANNULAS	24

IOL IMPLANTATION SOLUTIONS

STEP 1. CHOOSE THE IOL AND DELIVERY SYSTEM

PRELOADED IOL+DELIVERY SYSTEM

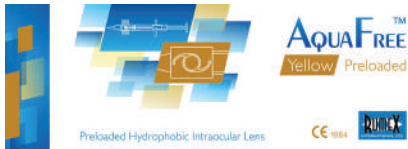

AquaFree Yellow Aspheric Preloaded

FEATURES:

- Fast injection
- Ready-to-use option

OR

NON-PRELOADED IOLS



AquaFree Yellow Aspheric



Hydro-Sense Yellow



Hydro-Sense

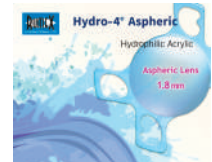

Hydro-4

DELIVERY SYSTEM

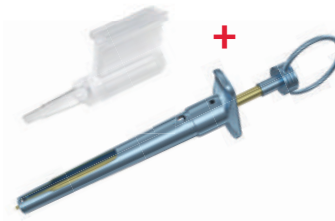

Single-Use Cartridge CAT-22 (2.2 mm) or CAT-24 (2.4 mm) + Reusable IOL Injector 16-2853

FEATURES:

- Money-wise solution
- Flexibility in choosing the IOL

OR



VE220 Disposable IOL Injector

FEATURES:

- Single-use option
- Flexibility in choosing the IOL

STEP 2. ADD THE OVD

DISPERSIVE

SUPREME HPMC 2%

BEST FOR:

- Coating the surgical instruments
- Endothelium protection

AND/OR

COHESIVE

SMARTVISC Sodium Hyaluronate 1.6%

SMARTVISC PLUS Sodium Hyaluronate 3%

BEST FOR:

- Keeping the empty capsular bag open for IOL insertion
- Flattening the anterior capsule to facilitate capsulorhexis creation

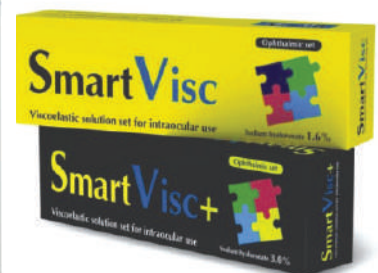

IOLs

HYDROPHOBIC IOLs*

Foldable aspheric monofocal one-piece IOLs

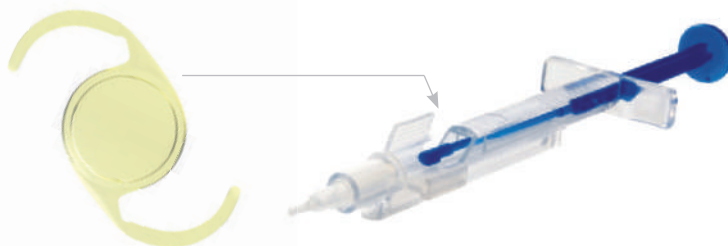

	AquaFree Yellow	AquaFree Yellow Preloaded
Min. incision size		2.2 mm
Overall diameter		13.0 mm
Optic diameter		6.0 mm
Power range		0D to +9D (1D steps) +10D to +30D (0.5D steps)
Self-unfolding		Yes
Water content		<0.5%
Angulation		0°
Material	Natural Yellow Hydrophobic Acrylic	
Optic design	Biconvex, 360° square edge	
Refractive index	1.5	
Abbe number	50	
Nominal A-constant	118.7	
Transition temp. of material	11°C	
Filtration	UV and Blue Light (400-475 nm)	
AC-depth	5.51	
Shelf life	5 years	

Optimized optical constants

Haigis:			HofferQ:	Holl.1:				Ref.
a0	a1	a2	pACD	sf	SRK/T	SRK II	n	
1.32	0.40	0.10	5.51	1.75	118.9	119.2	190	[304], [332]

Excellent long-term result

- Low chromatic aberration – increased contrast sensitivity, excellent color perception
- UV and Blue Light blocking – better protection of macula
- Extreme double square edge – no risk of secondary cataract development
- No spherical aberrations – minimized glare and unwanted images
- Implantation through a 2.2 mm incision – fast recovery
- Manufactured by the lathe-cut (LC) method – no glistenings

Easy and controlled implantation

- Special surface polishing – a lens does not stick to itself or to the instruments
- Low glass transition temperature – excellent material performance in operating conditions
- Optimal folding and unfolding ability – easy to inject
- Preloaded option available – simple and predictable IOL injection within less than 5 seconds



*Not available in the US

Product design and/or features that do not influence its functionality and main parameters are subject to change

HYDROPHILIC IOLs*

Foldable aspheric monofocal one-piece IOLs



	Hydro-4 Aspheric	Hydro-Sense Aspheric	Hydro-Sense Aspheric Yellow
Min. incision size	1.8 mm – suitable for MICS	2.2 mm	2.2 mm
Overall diameter	11.0 mm	12.5 mm	12.5 mm
Optic diameter		6.0 mm	
Power range		-5D to +9D (1D steps) +14D to +25D (0.5D steps) +25D to +38D (1D steps)	
Self-unfolding		Yes	
Water content		23.5 – 27.5 %	
Angulation		5°	
Material	Hydrophilic Acrylic	Hydrophilic Acrylic	Natural Yellow Hydrophilic Acrylic
Optic design		Biconvex, 360° square edge	
Refractive index		1.46	
Abbe number		55	
Nominal A-constant		118.0	
Filtration	UV	UV	UV and Blue Light
AC-depth		4.65	
Shelf life		5 years	

Optimized optical constants

Haigis:			HofferQ:	Holl.1:			n	Ref.
a0	a1	a2	pACD	sf	SRK/T	SRK II		
0.92	0.40	0.10	5.08	1.31	118.2	118.5	213	[341]

FEATURES

- High biocompatibility of hydrophilic material with eye tissues – no unwanted biological reactions
- No spherical aberrations – minimized glare and unwanted images
- Angulation 5° – reduced risk of secondary cataract development
- Double square edge – no posterior capsule opacification caused by cellular migration
- Manufactured by the lathe-cut (LC) method – no glistenings
- Minimized capsular bag stretching – maximum comfort for the surgeon and patient
- Excellent folding and unfolding ability – easy to inject
- Special surface polishing – a lens does not stick to itself or to the instruments

*Not available in the US

Product design and/or features that do not influence its functionality and main parameters are subject to change

DISPOSABLE INJECTION SYSTEMS, AND CARTRIDGES

**DON'T FORGET
TO BUY**

Disposable IOL Injection System
MEDICEL VISCOJECT™ Eco

VE2200*

STERILE



- Suitable for Hydrophobic and Hydrophilic IOLs
- Push version
- Soft-tip technology for one-piece IOLs
- Incision sizes range from 2.1 mm to 2.8 mm, depending on the operating technique used (fig.1)

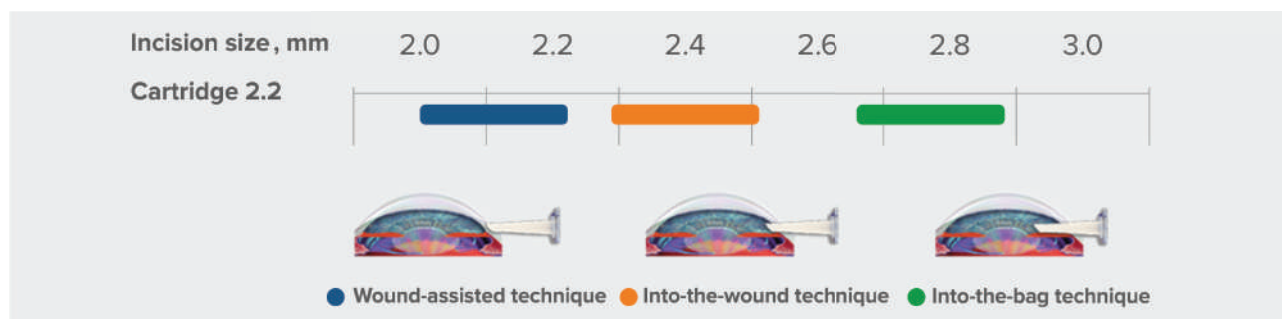

fig.1

Disposable Cartridges for IOL Injector**

Disposable cartridges are to be used with Reusable IOL Injector **16-2853** (page 121) for foldable one-piece IOLs

CAT-22 for 2.2 mm incision

CAT-24 for 2.4 mm incision

CAT-27 for 2.7 mm incision

NEW **STERILE**



*Not available in the US

**Not available in Europe

Product design and/or features that do not influence its functionality and main parameters are subject to change

OVDs

SUPREME* Ophthalmic Viscosurgical Device

Supreme is a dispersive viscoelastic solution of low molecular weight, highly purified grade of hydroxypropyl methylcellulose (HPMC) 2%, clear, isotonic, sterile, non-inflammatory and non-pyrogenic in nature. It is used for intraocular injection during anterior segment surgery.

Physico-chemical properties

Classification	Dispersive
Composition	HPMC 2%
Molecular weight	86 000 Da
Viscosity	3 000–4 500 cSt
pH	6.0–7.8
Osmolality	250–350 mOsmol/kg
Volume	2 ml
Storage	2-35°C
Shelf Life	3 years

Advantages

- The best endothelial protection
- Easy removal
- Completely transparent
- No refrigeration necessary
- Easy transportation and storage (2–35°C)

Dispersive Solution Supreme is used to:

- Coat ocular structures during cataract surgery: in the initial part, during capsulorhexis and phacoemulsification
- Protect corneal endothelium in the eye where endothelium pathology is suspected

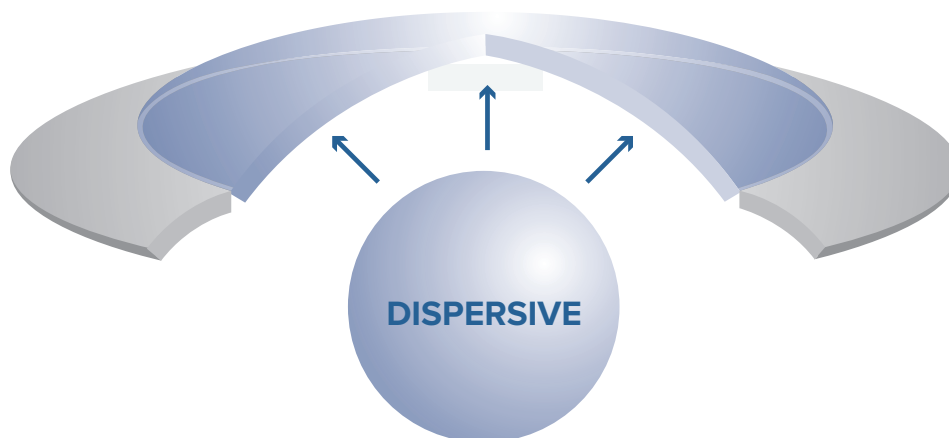

SMARTVISC/SMARTVISC PLUS* Ophthalmic Viscosurgical Device

SmartVisc is a cohesive, sterile, highly purified, non-inflammatory, sodium hyaluronate viscoelastic solution with high molecular weight. It is used to keep the anterior chamber formed, to keep the anterior capsule flat during capsulorhexis creation, to move and manipulate iris or other tissues and to keep the empty capsular bag open for IOL insertion.

	SmartVisc	SmartVisc PLUS
Classification	Cohesive	
Composition	Sodium Hyaluronate 1.6 %	Sodium Hyaluronate 3.0 %
Molecular weight	1.2–2.0 mDa	1.0–1.8 mDa
Viscosity	approx. 80 000 mPas	approx. 400 000 mPas
Osmolality	270–400 mOsmol/kg	
Storage	2–25°C	
pH	6.8–7.4	
Volume	1 ml	
Shelf Life	3.5 years	



Advantages

- Good maintenance of the anterior chamber and the capsular bag
- Controlled capsulorhexis
- Easy IOL implantation
- Better adhesiveness to the corneal endothelium during phacoemulsification
- Excellent protection against mechanical damages
- No refrigeration necessary
- Ready-to-use

Cohesive Solution SmartVisc is used to:

- Maintain space and pressure in the eye
- Keep the empty capsular bag open for IOL insertion
- Support the anterior chamber and flatten the anterior capsule
- Dilate small pupils
- Dissect areas of adhesion

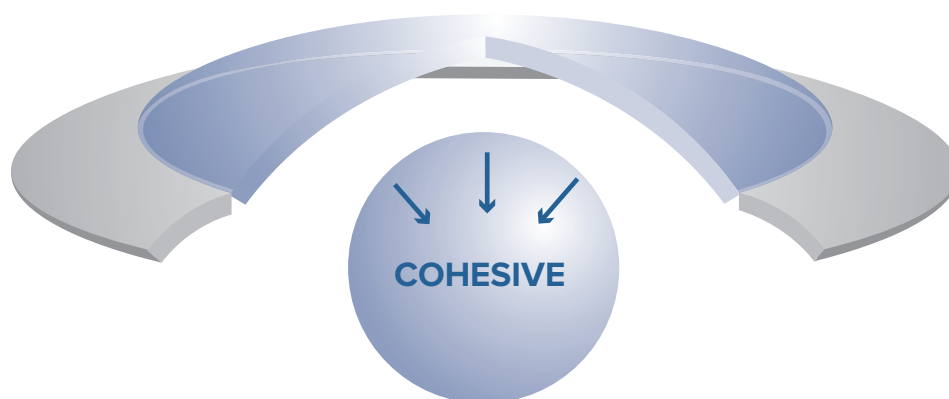

*Not available in the US

Product design and/or features that do not influence its functionality and main parameters are subject to change

DISPOSABLE KNIVES

Disposable Knives are supplied sterile in a box of 6

STERILE **2** **6** PER BOX

ALL KNIVES ARE EQUIPPED WITH SAFETY LIDS

CATARACT

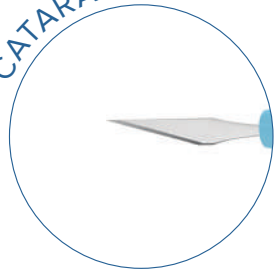

Side-Port Knives

Initial stab incisions
Straight, double bevel

SP-15 1.00 mm, 15°
SP-30 1.00 mm, 30°
SP-45 1.00 mm, 45°

POPULAR

CATARACT

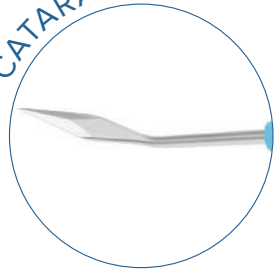

Paracentesis Knives

Paracentesis incisions/side port incisions
Angled, double bevel

PK-11 1.10 mm

CATARACT

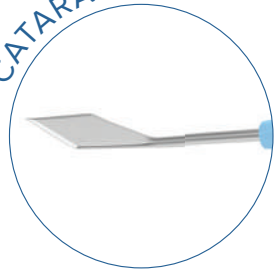

Slit Knives

Scleral tunnel incisions
Angled, single bevel

SL-22 2.20 mm
SL-24 2.40 mm
SL-26 2.65 mm
SL-27 2.75 mm
SL-28 2.80 mm
SL-32 3.20 mm

POPULAR

POPULAR

CATARACT



Trapezoidal Knives

Tunnel incisions
Angled, single bevel

TR-10 1.20-1.40 mm
TR-17 1.50-1.70 mm

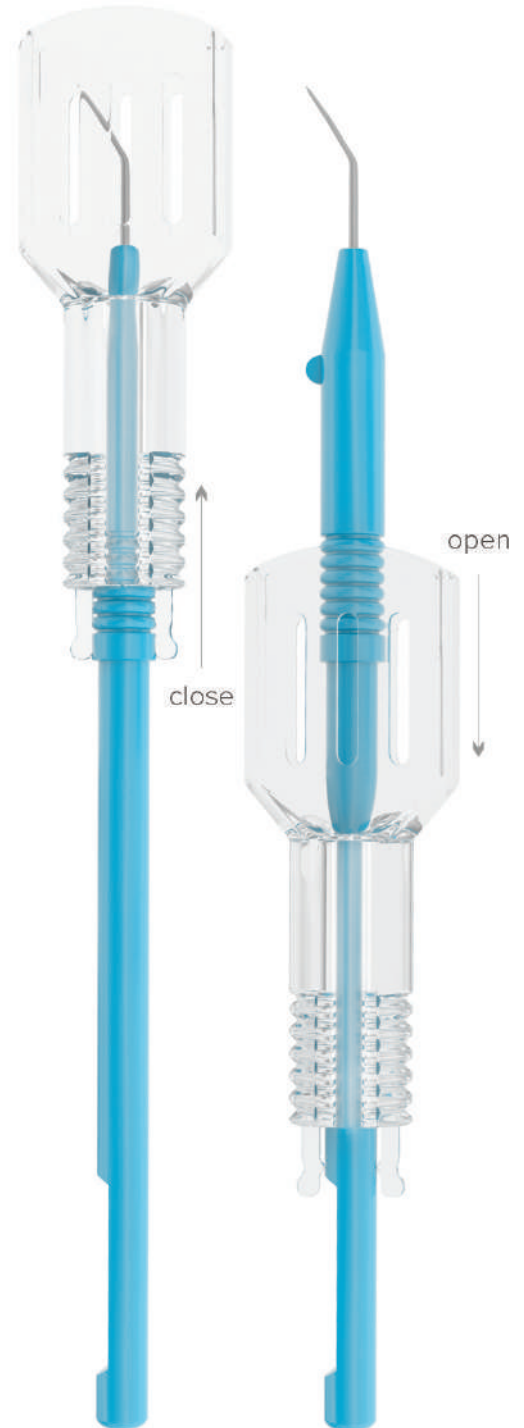

CE
2803

STERILE **2** **6** PER BOX

CATARACT

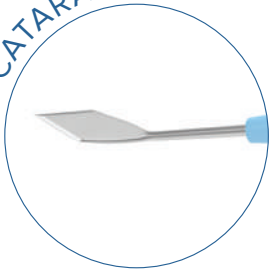

Clear Corneal Knives

Clear corneal incisions
Angled, double bevel

CC-22 2.20 mm **POPULAR**
CC-24 2.40 mm
CC-26 2.65 mm
CC-27 2.75 mm **POPULAR**
CC-30 3.00 mm

CATARACT

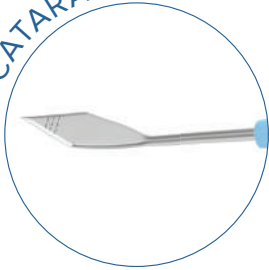

Clear Corneal Knives with Depth Indicators

Tunnel incisions
Angled, double bevel

CCD-22 2.20 mm 1.50, 1.75 mm depth indicators
CCD-24 2.40 mm 1.50, 1.75, 2.00 mm depth indicators
CCD-26 2.65 mm 1.50, 1.75, 2.00 mm depth indicators
CCD-27 2.75 mm 1.50, 1.75, 2.00 mm depth indicators **POPULAR**

GLAUCOMA

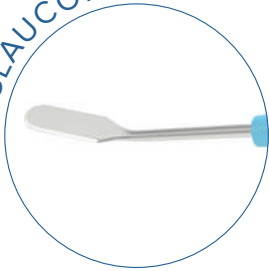

Crescent Knives

Lamellar dissections/scleral tunnel,
flap formation
Angled, single bevel

CR-20 2.00 mm **POPULAR**

LRI

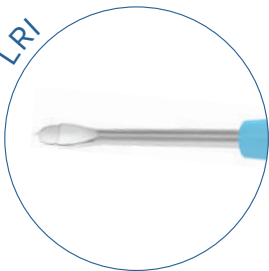

Pre-Set Knives

Groove making/limbal relaxing incisions
Multifacet

PD-60 600 µm Depth

VITREORETINAL

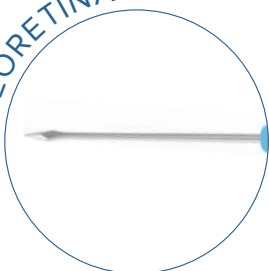

MVR Knives

Posterior segment penetration/side port incisions
Straight, multifacet

VRS-19 19 Ga
VRS-20 20 Ga **POPULAR**
VRS-23 23 Ga

Angled, multifacet

VRA-19 19 Ga
VRA-20 20 Ga
VRA-23 23 Ga

CE
2803

DISPOSABLE INSTRUMENTS

STERILE **2** **6** PER BOX

All stainless steel disposable instruments are designed for precise manipulations during anterior segment surgeries.

Speculums

Barraquer Wire Speculum

Overall length 40 mm
Sterile, box of 6

14-022D **POPULAR**



Spatulas and Manipulators

Overall length 120 mm
Sterile, box of 6



Sinskey Hook

Angled
5-032D



Rosen Phaco Chopper

Universal
7-065D **POPULAR**



Lester Lens Manipulator

Angled
5-0331D



Nagahara Phaco Chopper

RHD
7-063D **POPULAR**

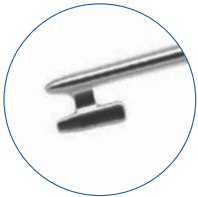

Kuglen Iris Hook

Angled
5-030D



Drysdale Nucleus Manipulator

Universal
7-093D



Spatula for
Femtosecond Laser Procedure
20-204D

Forceps

Overall length 104 mm
Sterile, box of 6

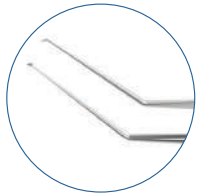

Utrata Capsulorhexis Forceps

Cystotome tips
Straight

4-0311D **POPULAR**

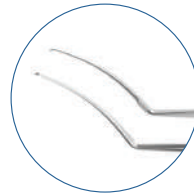

Utrata Capsulorhexis Forceps

Cystotome tips
Curved

4-0331D **POPULAR**

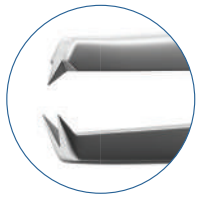

Castroviejo Suturing Forceps

0.12 mm

4-0600D **POPULAR**

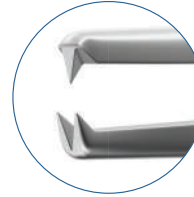

Bonn-Catalano Corneal Forceps

0.12 mm

4-0551D

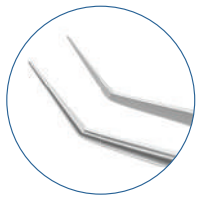

McPherson Tying Forceps

Angled

4-174D **POPULAR**

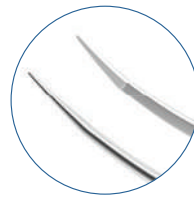

McPherson Tying Forceps

Curved

4-177D **POPULAR**

Scissors

Sterile, box of 6

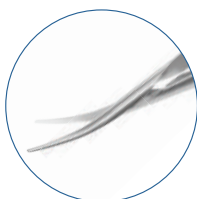

Castroviejo Universal Corneal Scissors

Blunt tips
Overall length 106 mm

11-012D

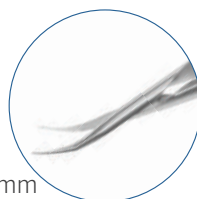

Westcott Tenotomy Scissors

Blunt tips
Overall length 115 mm

11-040D **POPULAR**

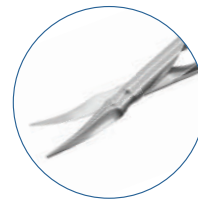

Vannas Capsulotomy Scissors

Sharp tips
Overall length 84 mm

11-052D **POPULAR**



Disposable Set of Irrigation/Aspiration Handpieces

NEW

Aspiration



Irrigation

Set of I/A Handpieces for Bimanual Technique*

STERILE**2****5**
PER
BOX

Disposable

Aspiration – single port 0.35 mm

Irrigation – double port 0.40 mm

Delicate tips allow easy access to all parts of the capsule and may be introduced through any side-port incision.

- Lightweight, color-coded handpieces
- Standard male/female luer connector
- Compatible with Phaco or I/A system

7-0821D 21 Ga 5 sets per box

7-0823D 23 Ga 5 sets per box

Iris Retractors



Iris Retractor*

STERILE**6**
PER
BOX

Reusable

Supplied sterile in autoclavable PTFE container

10-5127 **POPULAR**

Iris Retractor*

Disposable

10-5016-1 4 per box

10-5067-1 5 per box

STERILE**2**

PVA Spears

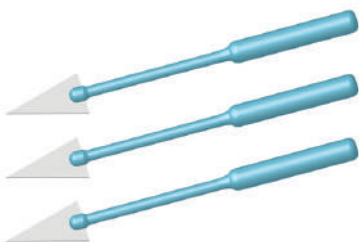
**STERILE****2****180**
PER
BOX**NEW**

Compressed lint-free PVA spears ideal for controlling and absorbing fluid in and around the orbital area during cataract and refractive procedures

R2-40405*

*Not available in Europe

Product design and/or features that do not influence its functionality and main parameters are subject to change

MANI OPHTHALMIC SUTURES*



The following list is for reference only.
 The sutures are used depending on the surgeon's techniques and preference.
 The sutures are supplied sterile in a box of 12.

Item Number	Suture		Needle				Main Application
	Description	Length	Shape	Length	Curve	Diameter	
10-0 Nylon Black Mono Sutures							
22-R1404		30 cm	Trape Spatula	5.5 mm	7/16 (158°)	0.14 mm	Cornea, Scleracornea, Sclera Flap
22-R1410		30 cm	Trape Spatula	7 mm	1/2 (180°)	0.14 mm	Scleracornea
22-R1404S		15 cm	Trape Spatula <i>Single-armed</i>	5.50 mm	7/16 (158°)	0.14 mm	Scleracornea
22-R2002		30 cm	Trape Spatula	6.50 mm	3/8 (135°)	0.20 mm	Scleracornea
5-0 Polyester Green Braided							
22-R3373		45 cm	Dia Spatula	8 mm	1/4 (90°)	0.33 mm	Operations on Vitreous
5-0 Polyester White Braided							
22-R3377		45 cm	Trape Spatula	8 mm	1/4 (90°)	0.33 mm	Operations on Vitreous
6-0 Silk Black Braided Sutures							
22-R3305		45 cm	Reverse Cut	11 mm	3/8 135°	0.33 mm	Skin, Ocular Muscles
22-R2801		45 cm	Trape Spatula	6.5mm	3/8 135°	0.28 mm	Skin, Ocular Muscles
8-0 PGA Absorbable Violet Braided Sutures							
22-R2090		30cm	Trape Spatula	6.5mm	3/8 135°	0.20 mm	Conjunctiva, Sclera, Closing MVR Port

*For sale in the US only

Product design and/or features that do not influence its functionality and main parameters are subject to change

DISPOSABLE CANNULAS

DISPOSABLE CANNULAS GAUGE CONVERSION CHART

A hub of each cannula has a color according to its gauge.

To learn more, please see the cannula gauge conversion chart below.

Gauge	Inner Diameter		Outer Diameter		Color Code
	In	mm	In	mm	
19G	.028	.70	.043	1.10	
20G	.024	.60	.036	.90	
21G	.020	.51	.032	.80	
22G	.016	.41	.028	.70	
23G	.013	.33	.025	.60	
24G	.012	.30	.022	.55	
25G	.010	.25	.020	.50	
26G	.010	.25	.018	.45	
27G	.008	.20	.016	.40	
30G	.006	.15	.012	.30	

DISPOSABLE CANNULAS*

ANESTHESIA CANNULAS

Used for anesthetic agents administration during ophthalmic surgeries.



Atkinson Retrobulbar Needle

21-R1125 25 Ga × 38 mm **POPULAR**

Sub-Tenon's Anesthesia Cannula

21-R1320 20 Ga × 25 mm

ANTERIOR CHAMBER CANNULAS

Used for maintaining and forming the anterior chamber by injecting or removing air, fluids, viscoelastics and intraocular medications.

Rycroft Anterior Chamber Cannula

4 mm angled tip

21-R2023 23 Ga × 22 mm

21-R2030 30 Ga × 22 mm

8 mm angled tip

21-R2027-8 27 Ga × 22 mm



Viscoelastic Cannulas

Used for maintaining and forming the anterior or posterior chamber by infusing or aspirating viscoelastic.

9 mm angled tip

21-R2225 25 Ga × 22 mm **POPULAR**

21-R2227 27 Ga × 22 mm **POPULAR**

10 mm angled tip

21-R2327 27 Ga × 22 mm **POPULAR**

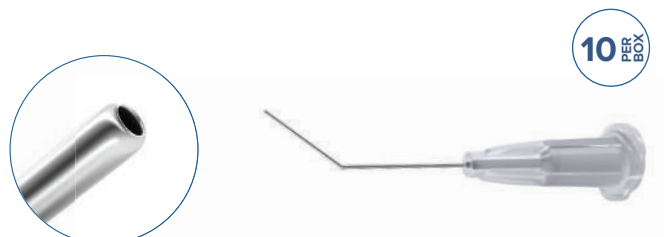

*Not available in Europe

Product design and/or features that do not influence its functionality and main parameters are subject to change

HYDRODISSECTION CANNULAS

The hydrodissection cannulas with special tips are designed to be placed under the edge of the anterior capsulorhexis and toward the lens equator to deliver fluids to free the adhesions of the cataract from the capsular bag and allow it to rotate fully.

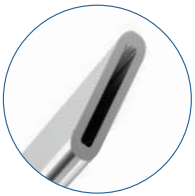
10
PER
BOX

Pearce Hydrodissector

Angled 32°, spatulated tip

8 mm angled tip

21-R4025 25 Ga × 22 mm **POPULAR**

10 mm angled tip

21-R4027 27 Ga × 22 mm **POPULAR**

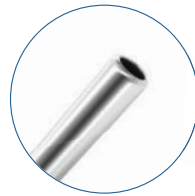
10
PER
BOX

Hydrodissector

Angled 32°,

Round smooth tip, 10 mm angled tip

21-R4427 27 Ga × 22 mm

CYSTOTOME CANNULAS

Used to perform capsulorhexis. Tip is designed for opening of anterior capsule.

Pearce Irrigating Cystotome

21-R3027 27 Ga × 16 mm

10
PER
BOX

REFRACTIVE CANNULAS

Used after ablation to wash away particulates from anterior and posterior sides of flap and stromal bed.

Lindstorm Lasik Irrigating Cannula

3 ports

Formed 7 mm

Smooth angle curvature allows for safe flap alignment

21-R7430 25 Ga × 25 mm

10
PER
BOX

*Not available in Europe

Product design and/or features that do not influence its functionality and main parameters are subject to change

LACRIMAL CANNULAS AND SETS

For surgical treatment, repair and irrigation of the nasolacrimal system.

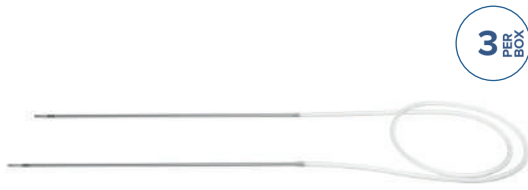

3
PER
BOX

Lacrimal Intubation Set

Silicone tubing 30 cm
Stainless Steel probes
ID – 0.30 mm
OD – 0.60 mm

21-R7001 23 Ga × 17.5 cm probe



3
PER
BOX

Retrieval Device



Lacrimal Intubation Set

Olive tip
Silicone tubing 35 cm
Stainless Steel probes

21-R7004 27 Ga × 11 cm probe
21-R7004RD 27 Ga × 11 cm probe
(with retrieval device)



3
PER
BOX

DCR Set

Silicone tubing 30 cm
Stainless Steel probes

21-R7011 20 Ga × 45 mm probe, straight
21-R7012 20 Ga × 45 mm probe, angled
(shown)



3
PER
BOX

Lacrimal Intubation Tubing

Silicone tubing 30 cm
ID – 0.30 mm
OD – 0.60 mm

21-R7002

Lacrimal Cannulas

21-R7021 21 Ga × 33 mm
21-R7026 26 Ga × 28 mm

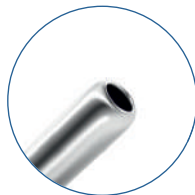

10
PER
BOX



*Not available in Europe

Product design and/or features that do not influence its functionality and main parameters are subject to change

POPULAR

SKU preferred by the majority of customers

NEW

Recently introduced into the product range of RUMEX International Co.



Disposable instruments



Available in a single-use edition



Available in Stainless Steel



Featured instrument in the set on page 100

**DON'T FORGET
TO BUY**

Frequently bought together



Quantity in the box

NEW

RUMEX continuously expands the range of instruments focusing on the up to date surgical techniques.

The latest portion of new products includes innovative tools for cataract and refractive surgeries, and corneal transplantation.

The set of instruments developed by Eric Abdullayev MD, USA includes unique tools that will facilitate graft management and save its integrity.

Cataract section features the newest products such as Phaco chopper for Cross-chop technique that will reduce the use of ultrasound and Universal multifunctional phaco chopper combining 3 functions in one tool – chopping, retraction and cracking.

New Femto spatula with blunt tips is specially designed for easy entering point detection and incision opening. Double cross-action capsulorhexis forceps with micro-thin jaws is the most delicate tool to enter a 1.50 mm incision.

The range of irrigation/aspiration handpieces is now completed with disposable sets in 21 and 23 gauges.

The set of instruments for SMILE procedure includes tools that will facilitate lenticule management. And new LRI marker will precisely place arcuate marks even without the use of ink.

We are pleased to offer RUMEX FLUSHING SYSTEM as one of the latest innovative achievements that allows for efficient cleaning of vitreoretinal tools without disassembling and promotes longevity of instruments.

CATARACT

4-033S

Small-Incision Capsulorhexis Forceps with Double Cross-Action and Scale

Cystotome tips
Micro-thin jaws
Flat handle
For 1.50 mm incisions
Overall length 105 mm
Stainless Steel



- Cross-action prevents the hyperextension of the incision
- Micro-thin jaws contribute to free movements in the anterior chamber
- Sharp and delicate cystotome tips allow to make the first pinch easily
- Tungsten carbide coating provides for better gripping

7-0681

Phaco Chopper for Cross-Chop Techniques

Overall length 120 mm



- Designed for Cross Chop and Quick Chop techniques.
- Elongated distal part fractures all lens densities
 - Rounded tip protects the posterior capsule
 - Reduces the use of Ultrasound to lower the risk of endothelial cells loss

7-0751

Universal Multifunctional Phaco Chopper

Overall length 120 mm



- Anterior sharp edge for horizontal and vertical nucleus chopping
- Blunt posterior surface for iris or capsular rim retraction
- Rounded tip is safe for the capsule and useful in nucleus cracking

7-0821D 21 Ga
7-0823D 23 Ga

Disposable Set of I/A Handpieces for Bimanual Technique*

STERILE **2** **5** PER BOX

Aspiration – single port 0.35 mm
 Irrigation – double port 0.40 mm

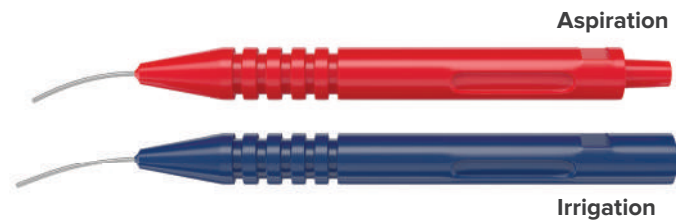

Delicate tips allow easy access to all parts of the capsule and may be introduced through any side-port incision.

Each set includes 5 irrigation and 5 aspiration handpieces.

- Lightweight, color-coded handpieces
- Standard male/female luer connector
- Compatible with Phaco or I/A system

20-061 Double-Ended Femto Spatula

Overall length 132 mm

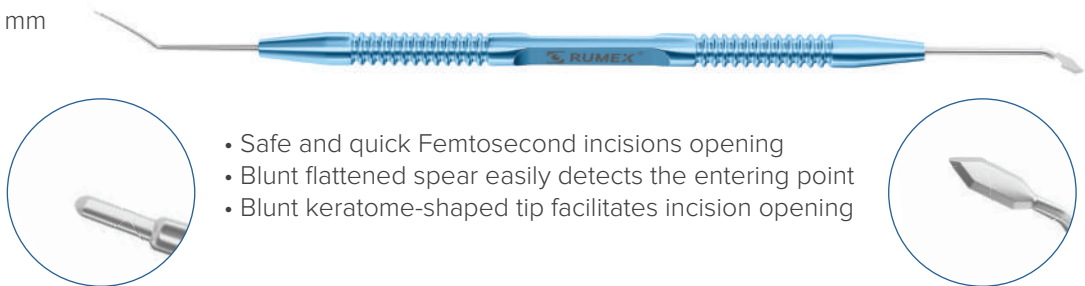

- Safe and quick Femtosecond incisions opening
- Blunt flattened spear easily detects the entering point
- Blunt keratome-shaped tip facilitates incision opening

*Not available in Europe

Product design and/or features that do not influence its functionality and main parameters are subject to change

CORNEAL

3-024T**Abdullayev I & II Marker**

(for DSAEK/DMEK grafts)

Overall length 135 mm
Titanium

- I & II marks do not interfere with vision
- Provides for more stable staining
- Allows to apply 1.50 mm straight I & II marks at the very edge of the graft
- Requires no additional tissue manipulation (no punch holes, no folding or unfolding of the graft)
- Saves time during graft preparation

**3-208T****DMEK/DSAEK "S" Marker**Overall length 115 mm
Titanium

- Thin "S" leaves a fine line with less ink transferred to the corneal stroma
- Optimal angle provides for better visualization of "S" while marking

**4-254S****Lambright-Abdullayev Ultrathin DSAEK Grasping/Inserting Forceps**Overall length 105 mm
Stainless Steel

Designed to improve insertion of the ultrathin DSAEK grafts especially with thickness 70 microns and less.

- Space between the tips is 120 microns to minimize compression and provide more safety for donor endothelial cells
- Wave-shaped serration of grasping platforms on tips for nonslip insertion while allowing atraumatic forceps removal

**4-261S****Abdullayev DMEK Grasping Forceps**Overall length 82 mm
Stainless Steel

- Improved angle between grasping platform, the rest of the forceps allows relaxing hand position and more control when in use
- Horizontal thin grasping platforms provide more stability in membrane holding during separation



REFRACTIVE

4-266S SMILE Lenticule Extraction Forceps with a View-Port

Overall length 106 mm
Stainless Steel



Designed to grasp the lenticule and remove it from the corneal pocket.

- Wide gripping area and atraumatic flattened tips for easy and safe manipulations
- Curved shafts adhere to the curvature of the cornea
- View-port for enhanced visualization

**4-268S SMILE Lenticule Extraction Forceps with Serrations**

Overall length 84 mm
Stainless Steel

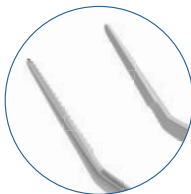

Designed to grasp the lenticule and remove it from the corneal pocket.

- Ultrathin tips are safe for the pocket walls
- Composite surface of the tips (texturized and serrated) ensures the efficient grasping of the lenticule

**20-2073 SMILE Lenticule Removing Spatula**

Overall length 120 mm



- Double-function tool
- Delicate reversed hook for easy identification and capture of lenticule edge
- Modified spatula for smooth and safe removal

**3-183T LRI Marker**

Intra-op
30, 45, and 60 degree marks
Overall length 116 mm
Titanium

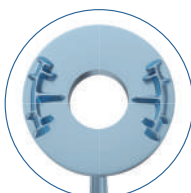

- Low-profile marker
- Thin beveled blades on the rotatable head precisely place arcuate marks along the axis even without the use of ink

Product design and/or features that do not influence its functionality and main parameters are subject to change

ONE-PIECE VITREORETINAL INSTRUMENTS WITH RUMEX FLUSHING SYSTEM

Complete tool – no need to adjust the tip to the handle

Delicate cleaning – flushing liquid streams towards the tips with zero stress for the jaws

Increased lifespan – the inner mechanism is not involved into the cleaning process and stays intact

- The tip can be easily cleaned without disassembling
- Special flushing cannula is provided for free
- Color coding allows to identify the type and gauge of the instrument
- A wide range of tips available in 23 and 25 gauges



Flushing port

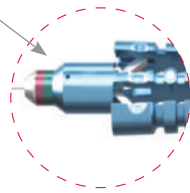

Flushing cannula

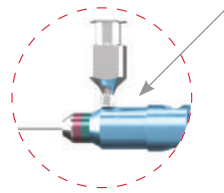

Please follow the cleaning instruction to increase the lifespan of the tool:

1. Insert the cannula into the flushing port as illustrated
2. Adjust a syringe to rinse with distilled water, alcohol, dry with air
3. Sterilize the instrument in the regular way

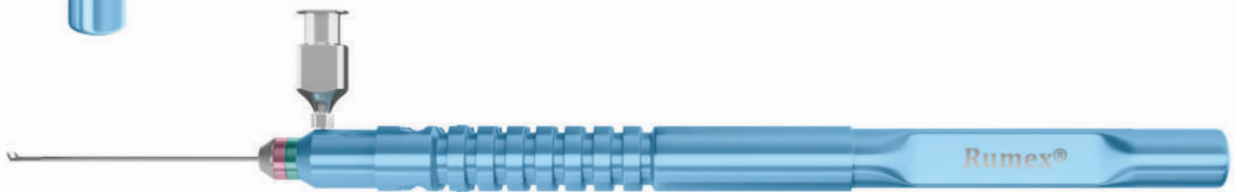

REUSABLE ANTERIOR INSTRUMENTS

BLADE HOLDERS	36
CALIPERS & GAUGES	37
MARKERS	39
A VARIETY OF CAPSULORHEXIS FORCEPS	45
FORCEPS	47
HOOKS	71
DIAMOND KNIVES	74
SAPPHIRE KNIVES	77
PHACO INSTRUMENTS	78
NEEDLE HOLDERS	87
PROBES	89
RETRACTORS	90
SCISSORS	92
SPATULAS	98
SPECULUMS	108
CANNULAS	113
MISCELLANEOUS	119
STERILIZATION TRAYS	124
LASEK/LASIK INSTRUMENTS	127

BLADE HOLDERS

Blade Holder

Round knurled handle with end lock
Polished finish
Overall length 95 mm
Titanium

1-010T **POPULAR**



Bard Parker Handle

Suitable for blades # 10, 11, 12, 15, 15C
Flat serrated handle
Overall length 125 mm
Stainless Steel

1-020S **POPULAR**



CALIPERS & GAUGES

CALIPERS & KERATOMETERS



Castroviejo Caliper

Measures from 0 to 20 mm.
Scale is engraved on both sides.
Polished finish
Overall length 87 mm
Titanium or Stainless Steel

2-010T 0-20.00 mm
2-010S 0-20.00 mm

POPULAR



Adler Wound Gauge

Used to measure incision width and depth (peripheral to central dimension) of a corneal/limbal wound.

Dull finish
Diameter 30 mm
Titanium

2-064T 2.00-2.50 mm

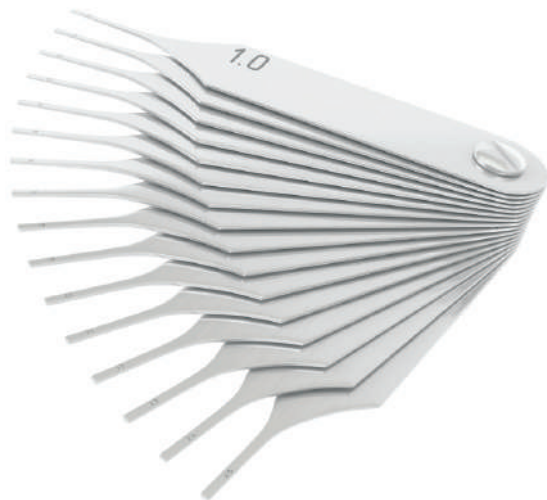

RUMEX Internal Micro Incision Gauges

16 stainless steel blades
0.10 mm increments marks
Overall length 75 mm
Stainless Steel

2-062S 1.00-2.50 mm



Braunstein Fixed Caliper

To make the mark for MVR blade entrance and intravitreal injections.
Marks the distance from limbus to sclera.
3.50/3.00 mm for aphakic and 4.00/3.50 mm for phakic eyes.

Overall length 80 mm
Titanium or Stainless Steel

2-101T 3.00/3.50 mm **POPULAR**
2-100T 3.50/4.00 mm **POPULAR**
2-100S 3.50/4.00 mm **POPULAR**

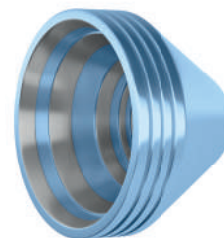

Maloney Intraoperative Keratometer

For qualitative measurement of astigmatism
Diameter 32.00 mm
Overall length 23 mm

16-020T **POPULAR**

GAUGES

Accurate axial alignment on the cornea

Used to determine incision angles.

LRI Gauge

Can be used with **3-090T Bores Axis Marker**.

Calibrated every 10 degrees from 0° to 180°.

With atraumatic fixation teeth

Dull finish

ID 13.00 mm/ED 19.00 mm

Overall length 134 mm

Titanium

2-031T

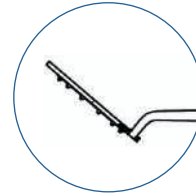
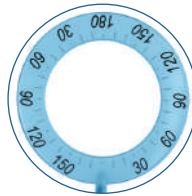

Mendez Degree Gauge

Can be used with **3-090T Bores Axis Marker**.

Calibrated every 10 degrees from 0° to 180°.

Dull finish

Titanium

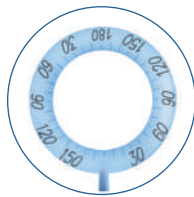

2-030S
SS

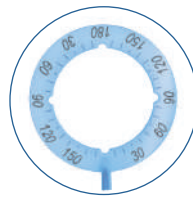

With 4 grooves for better marks visualization
ID 13.00 mm/ ED 18.00 mm
Overall length 136 mm

2-033T

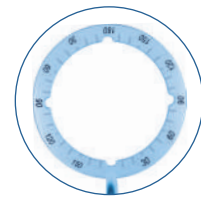

2-0331S
SS

With 4 grooves for better marks visualization
ID 13.00 mm/ED 16.50 mm
Overall length 122 mm

2-0331T **POPULAR**

2-030T **POPULAR**

Mendez Grooved Fine Degree Gauge

Can be used with **3-091T Bores Axis Marker**.

With 4 grooves for better marks visualization

ID 12.00 mm /ED 14.00 mm

Dull finish

Overall length 133 mm

Titanium

2-034T **POPULAR**

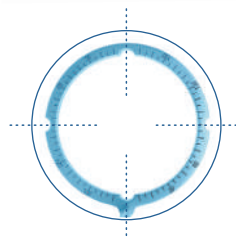

Degree Gauge with Beveled Face

Can be used with **3-091T Bores Axis Marker**.

ID 12.00 mm/ED 16.00 mm

Overall length 132 mm

Titanium

2-036T

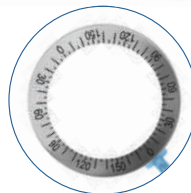

Product design and/or features that do not influence its functionality and main parameters are subject to change

MARKERS

AXIS MARKERS

Bores
Axis Marker
Intra-Op
Overall length 123 mm
Titanium

3-090S
SS



3-090T **POPULAR**
Used with **Gauges 2-030T, 2-031T, 2-033T, 2-0331T** to mark the axis.
12.00 mm blades

3-091T
Used with **Gauges 2-034T, 2-036T** to mark the axis.
11.50 mm blades

CAPSULORHEXIS MARKERS

Whipple
Capsulorhexis Centration Marker

Creates circular mark on the cornea to help gauge the size of the capsulotomy and its position.
Double-ended with 5.50/6.00 mm diameters
Overall length 140 mm

3-040 **POPULAR**

ECCE p.156
PHACO p.154

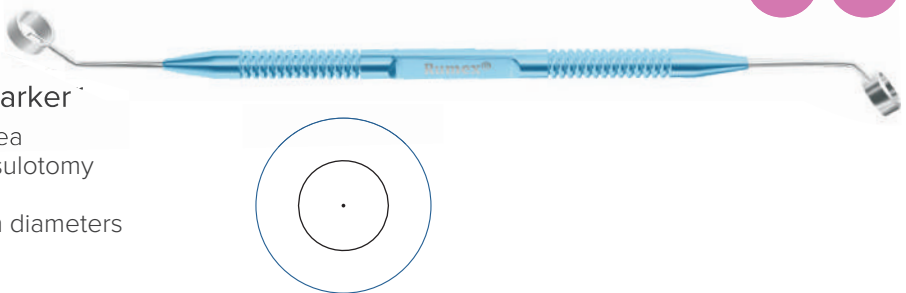

CORNEAL TRANSPLANT MARKERS

Abdullayev
Scleral Marker for Keratoplasty

Double-ended
(16.00 mm and 16.50 mm diameters)
Overall length 153 mm
3-0230

Improves scleral rim trimming process for corneas with large scleral rim prior to microkeratome processing.
Eliminates additional measurement.

NEW

DSEK, DSAEK, DMK
p.162



Abdullayev
Corneal Marker for Keratoplasty

Double-ended
(10.00 mm and 11.00 mm diameters)
With central marking point
Overall length 146 mm
3-0231

Improves centration of cornea during DSAEK microkeratome preparation.
Allows quick placement of the central dot. Facilitates placement of the donor corneas on to the donor punch.

NEW

DSEK, DSAEK, DMK
p.162



3 - MARKERS

Abdullayev I & II Marker
(for DSAEK/DMEK grafts)

Overall length 135 mm
Titanium

3-024T

NEW

DSEK, DSAEK, DMEK
p.162



I & II marks do not interfere with vision.
More stable staining
Applies 1.50 mm straight I & II marks at the very edge of the graft.
No additional tissue manipulation
Saves time during graft preparation.

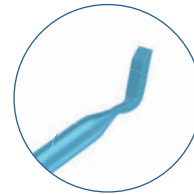

Osher-Neumann Corneal Marker

Low profile
8 radial blades
Overall length 130 mm
Titanium

3-0304T

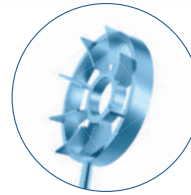
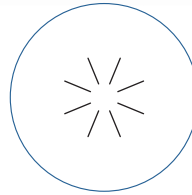

CORNEAL
p.161

Corneal Transplant Marker

7.00 mm ring with 8 radial blades
With center pointer
Overall length 123 mm
Titanium

3-140T

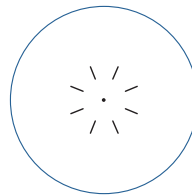

John DSAEK Double-Ended Marker

8.00/9.00 mm
Overall length 143 mm
Titanium

3-204T

NEW



DMEK/DSAEK "S" Marker

Overall length 115 mm
Titanium

3-208T

NEW

DSEK, DSAEK, DMEK
p.162



Thin "S" leaves a fine line with less ink transferred to the corneal stroma.
Optimal angle provides for better visualization of "S" while marking.

OPTICAL ZONE MARKERS

Hoffer Optical Zone Marker

With cross hairs
Overall length 130 mm
Titanium



3-0211T	5.00 mm	3-0217T	8.00 mm
3-0212T	5.50 mm	3-0218T	8.50 mm
3-0213T	6.00 mm	3-0219T	9.00 mm
3-0216T	7.50 mm		

Optical Zone Marker

Used to mark visual center for ICRS implantation procedure.
 Double-ended
 Visual center marker 0.15 mm wide
 Sinskey hook 0.50 mm wide
 Overall length 141 mm
 Titanium handle

3-034



ICRS
p.163

TUNNEL MARKERS

Tunnel Zone Marker

Marks tunnel for future ring position with initial lines for incisions.
 ID 4.00 mm/ED 6.00 mm
 Creates 2.00 mm lines.
 40° angled to handle
 Overall length 127 mm
 Titanium

3-143T



ICRS
p.163

LASIK MARKERS

Lavery LASIK Marker

With an optical center sight
 8.50 mm optical zone
 5 asymmetrical marking lines to ensure right placement of a corneal flap
 Overall length 130 mm
 Titanium

3-174T

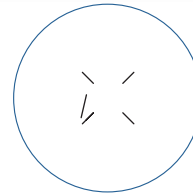
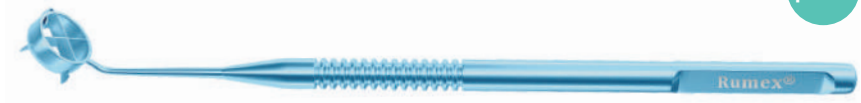

LASIK
p.159

LASIK Flap Marker

3 asymmetrical marking lines to ensure right placement of a corneal flap
 Designed both for nasal and superior hinge.
 Overall length 130 mm
 Titanium

3-176T

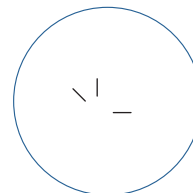

FEMTOLASIK
p.159

TORIC IOL MARKERS

Toric IOL Marker

Designed for LRI/Toric IOL implantation.
 Intra-Op
 Overall length 130 mm
 Titanium

3-181

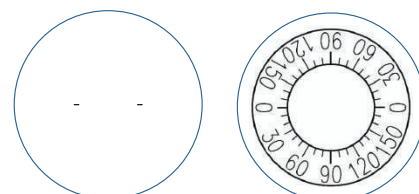

Product design and/or features that do not influence its functionality and main parameters are subject to change

3 - MARKERS

LRI MARKERS**LRI Marker**

Intra-Op
30-45-60°
Overall length 116 mm
Titanium

3-183T

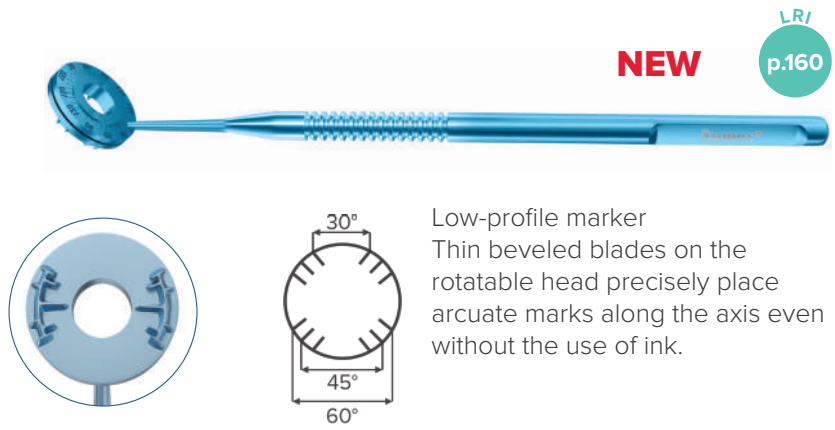

Low-profile marker
Thin beveled blades on the rotatable head precisely place arcuate marks along the axis even without the use of ink.

LRI Marker

Intra-Op
Automatically creates marks at 40-60-80°.
Overall length 130 mm
Titanium

3-1801

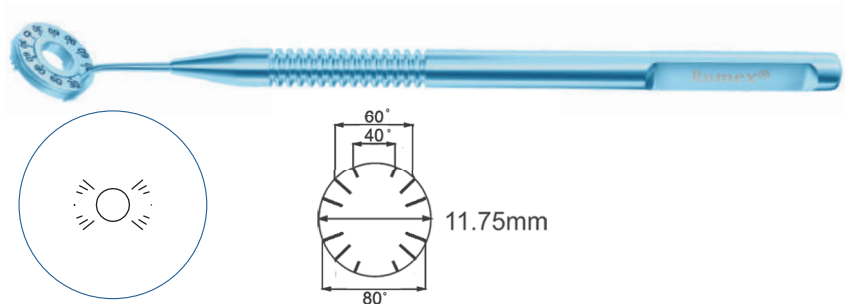
**LRI Axis Marker**

Pre-Op reference marker
Horizontal axis 3' and 9'
Overall length 120 mm
Titanium

3-190T

**LRI/TORIC MARKERS WITH GRAVITY WEIGHT SYSTEM**

Gravity weight system for precise stabilization of the scale not interfering with a grip

LRI Slit Lamp Gravity Marker

Pre-Op, 14.00 mm
Horizontal axis 3' and 9'
Overall length 138 mm
Titanium

3-191

**Lum LRI Gravity Axis Marker**

Pre-Op, 14.00 mm
Angled, horizontal axis 3' and 9'
Overall length 140 mm
Titanium

3-192

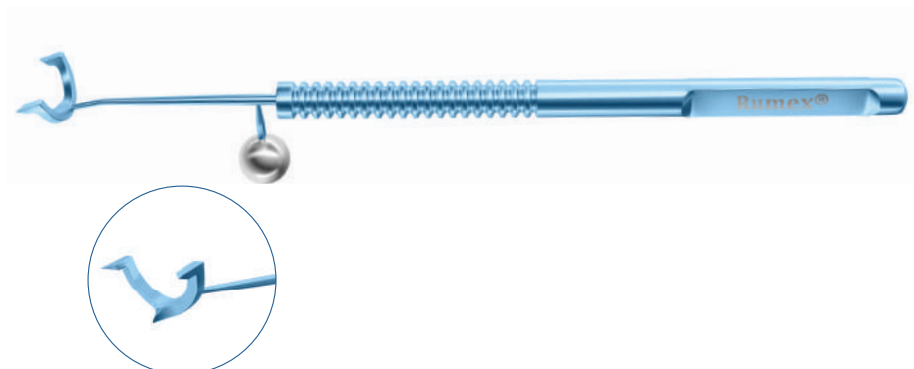

Product design and/or features that do not influence its functionality and main parameters are subject to change

Whitehouse Gravity Axis Marker

Marks the limbus at 3, 6 and 9 o'clock.
Helps to avoid the effect of cyclotortion.
Gravity weight system assures excellent visualization and balance.

Designed in cooperation with Geoff Whitehouse, M.D., Australia

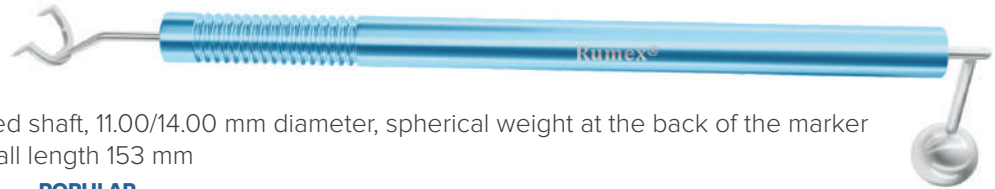
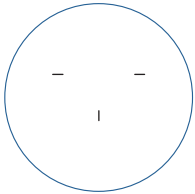

Angled shaft, 11.00/14.00 mm diameter, spherical weight at the back of the marker
Overall length 153 mm
3-193 POPULAR

Straight shaft, 11.00/14.00 mm diameter, spherical weight at the back of the marker
Overall length 152 mm
3-1931

Straight shaft, 9.50/12.00 mm diameter, cylindrical weight at the back of the marker
Overall length 153 mm
3-1932

RUMEX Toric Combo Marker

Marks both horizontal and toric axis pre-operatively, which eliminates an Intra-Op step.
Equipped with rotating ring for accurate alignment.
Reduces cyclotorsion effect in supine position.
Overall length 125 mm

3-194 Vertical axis
3-1941 Horizontal axis

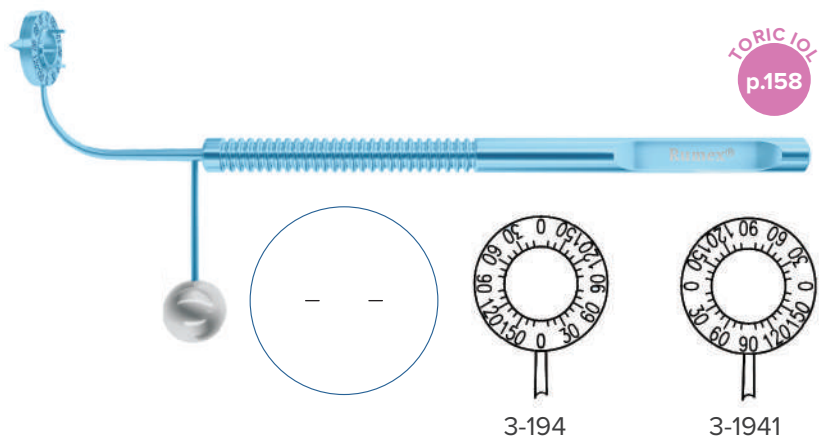

3-194

3-1941

Velazquez Gravity Corneal Marker for LRI/Toric IOL Implantation

Overall length 164 mm

3-195

Designed in cooperation with Jaime Velazquez O'Byrne, M.D., Colombia

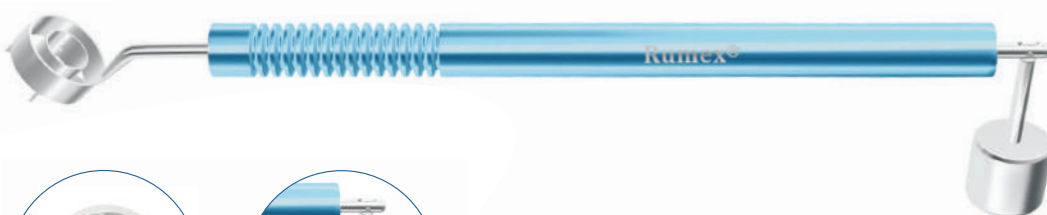

4 radial blades mark the horizontal and vertical meridians of the visual axis.
The internal marks help to check the IOL alignment at the end of the surgery.
The central 5 mm ring serves as a guide for capsulorhexis.
The outer ring protects blades from damage.
Angled shaft helps to avoid touching the lower eyelid.

Product design and/or features that do not influence its functionality and main parameters are subject to change

**Richman
Single-Step Toric Marker**

Designed to mark the desired axis of toric placement.
Angled shaft
Overall length 132 mm

Designed in cooperation with
**Jesse Richman,
M.D., USA**



3-196 POPULAR

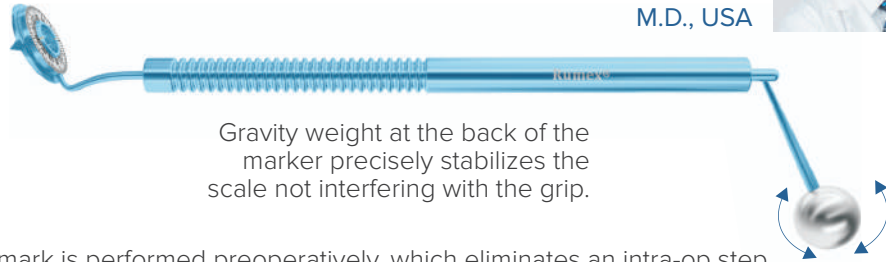

Gravity weight at the back of the marker precisely stabilizes the scale not interfering with the grip.

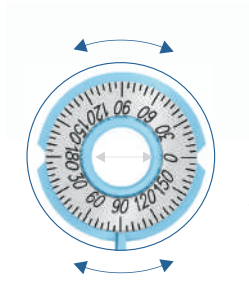

The mark is performed preoperatively, which eliminates an intra-op step. New design makes markings and degree scale more visible, allowing better accuracy. The outer barrel has indentations which make it easy to rotate. Ergonomic handle, angled to avoid the lower eyelid when marking while still being able to rest your hand on the patient's cheek for stability. A wide central opening for better centration when marking.

MARKING PENS

**DON'T FORGET
TO BUY**

STERILE



Disposable Marking Pen

Double-ended
20-050 POPULAR

A VARIETY OF CAPSULORHEXIS FORCEPS

STANDARD

3.0 mm

4-03315T Utrata Capsulorhexis Forceps with Scale

Cystotome tips, TC*

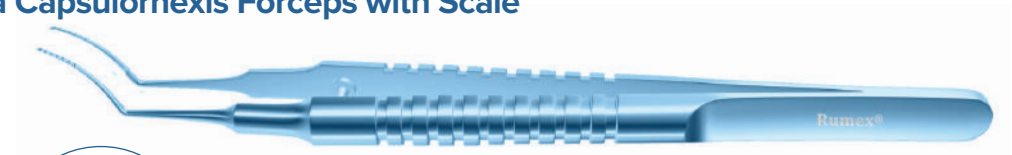

Scale for measuring the size of capsulorhexis

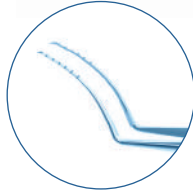

Curved shafts prevent corneal deformation.

4-0331D Disposable Utrata Capsulorhexis Forceps

STERILE



Cystotome tips



POPULAR

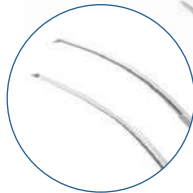

- ✓ Meets quality standards applied to reusable tools
- ✓ Always ready to use

SMALL-INCISION



Internal limiter prevents the jaws from opening wider than intended.

2.0 mm

4-0312S Microcoaxial Capsulorhexis Forceps with Alignment Mechanism

Cystotome tips, TC*



POPULAR

Limited to 2.00 mm



4-032S Small-Incision Capsulorhexis Forceps with Limiter and Wide Opening

Cystotome tips, TC*



POPULAR

Scale for measuring the size of capsulorhexis



View-port for better visualization

2 engravings at 2.50 and 5.00 mm for measuring the rhexis

Limited to 2.00 mm

*TC – Tungsten Carbide coating makes the platform rough enough for controlled gripping and prevents adhesion of the capsule. Product design and/or features that do not influence its functionality and main parameters are subject to change

SMALL-INCISION**1.5 mm****4-0395 Capsulorhexis Forceps with Cross-Action and Scale****POPULAR**

Cystotome tips, TC*



Scale for measuring the size of capsulorhexis



- ✓ Cross-action prevents hyperextension of the incision
- ✓ Hinge joints ensure even distribution of pressure at three points of forceps

4-033S Small-Incision Capsulorhexis Forceps with Double Cross-Action and Scale

Cystotome tips, TC*



Scale for measuring the size of capsulorhexis

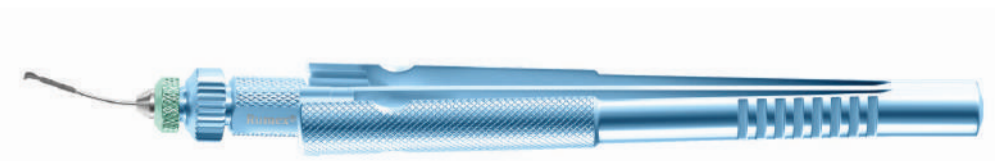

- ✓ Double cross-action guarantees fixed opening for free movements within the wound

MICS**sub 1.0 mm****4-03742 Lesieur Capsulorhexis Forceps with Internal Ruler****12-003T Universal Squeeze Handle**

Scale for measuring the size of capsulorhexis



Cystotome tips

Anti-glare coating

- ✓ 23 Ga tube minimally disrupts biomechanics of cornea
- ✓ MICS tips are used with RUMEX Universal Handle and can be easily disassembled for cleaning after the surgery

FORCEPS

CAPSULORHEXIS FORCEPS

Tungsten carbide coated cystotome tips for better gripping

Utrata Capsulorhexis Forceps

11.50 mm jaws
Flat handle



Straight jaws
Regular tips
Titanium
Overall length 82 mm
4-030T **POPULAR**



Straight jaws
Cystotome tips
Titanium
Overall length 82 mm
4-0300T **POPULAR**

4-0300S
SS

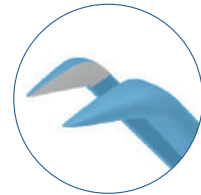

Straight jaws
Cystotome tips
Titanium
Overall length 107 mm
4-0301T **POPULAR**

4-0301S
SS

4-0321S
SS

Curved jaws
Cystotome tips
Titanium
Overall length 107 mm
4-0321T **POPULAR**



Nevyas Capsulorhexis Forceps

Straight jaws, 11.50 mm
Cystotome triangular claw-shaped tips
Overall length 105 mm
Titanium

4-0352T **POPULAR**



Microcoaxial Capsulorhexis Forceps with Limiter

Curved jaws, 11.50 mm
 Cystotome tips
 Ultra-thin profile and limiter for capsulorhexis even through 2.00 mm incision
 Round handle
 Overall length 106 mm
 Stainless Steel

4-0312S **POPULAR**

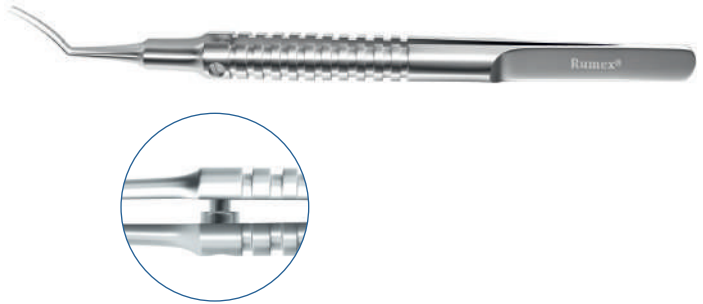

Inamura Style RUMEX Capsulorhexis Forceps

Designed to fit through incisions down to 2.00 mm.
 Recommended for coaxial phacoemulsification.
 Curved jaws
 Cystotome tips
 Round handle
 Overall length 115/117 mm
 Stainless Steel

4-0391S jaws 10.00 mm, for corneal incision
 4-0392S jaws 12.00 mm, for scleral incision

POPULAR
POPULAR



Utrata Capsulorhexis Forceps

11.50 mm jaws
 Round handle
 Titanium
 Overall length 110 mm

4-03114T, 4-03115T, 4-03314T, 4-03315T
 Engravings for precise measurement inside the anterior chamber

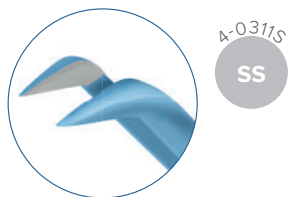

Straight jaw
 Cystotome tips
 4-0311T **POPULAR**



Straight jaws
 Regular tips
 4-031T **POPULAR**

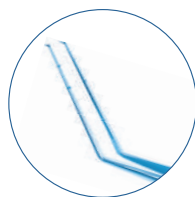

Straight jaws
 Cystotome tips, with ruler
 2 engravings at 3,6 mm
 4-03114T

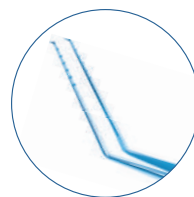

Straight jaws
 Cystotome tips, with ruler
 6 engravings at 1,2,3,4,5,6 mm
 4-03115T **POPULAR**



Curved jaws
 Cystotome tips
 4-0331T **POPULAR**



Curved jaws
 Cystotome tips, with ruler
 2 engravings at 3,6 mm
 4-03314T **POPULAR**

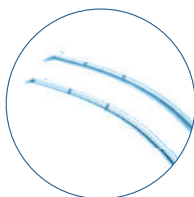

Curved jaws
 Cystotome tips, with ruler, 6 engravings at 1,2,3,4,5,6 mm
 4-03315T **POPULAR**

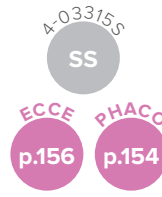

Small-Incision Capsulorhexis Forceps

Curved micro-thin jaws
Cystotome tips
With limiter
For 2.00 mm incisions
Flat handle
Overall length 105 mm
Stainless Steel

4-032S **POPULAR**



Small-incision Capsulorhexis Forceps with Double Cross-Action and Scale

Micro-thin jaws with fixed opening contribute to free movements in the anterior chamber

Micro-thin jaws
Cystotome tips
Flat handle
For 1.50 mm incisions
Overall length 105 mm
Stainless Steel

4-033S

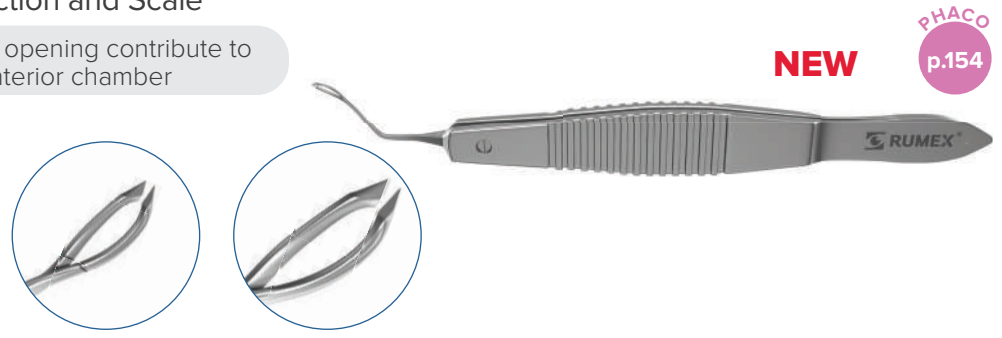

Cross-Action Capsulorhexis Forceps with Scale

Cross-action prevents the viscoelastic leakage and protects the incision from hyperextension

Hinge joints allow for enhanced durability and even distribution of pressure at three points of the tool

Jaws 8.50 mm
Scale of 2.50 mm, 5.00 mm from the tip
For 1.50 mm incisions
Overall length 110 mm

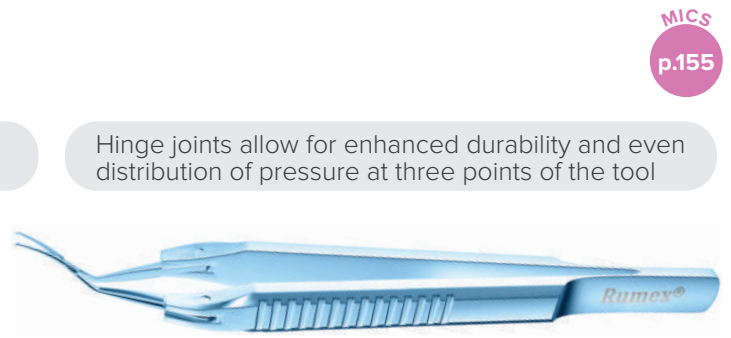

Curved Stainless Steel Jaws



Flat Handle, Titanium
4-0395 **POPULAR**

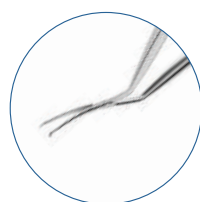

Round Handle, Titanium
4-0394

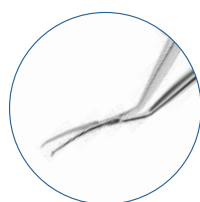

Flat Handle, Stainless Steel
4-0395S

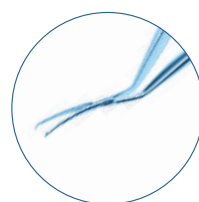

Curved Jaws, Titanium
Flat Titanium Handle
4-0395T

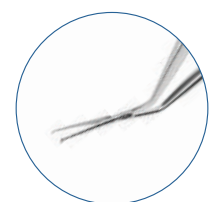

Straight Jaws, Stainless Steel
Flat Titanium Handle
4-0396

CROSS-ACTION CAPSULORHEXIS FORCEPS

NEW

Tungsten carbide coated cystotome tips allow to make the first pinch easily.

Curved shafts prevent corneal deformation.

Cross-action prevents the viscoelastic leakage and protects the incision from hyperextension.

Engravings assist in measuring the rhexis.

Hinge joints allow for even distribution of pressure at three points.

**Fits through a 1.50 mm incision.
8.50 mm tips**

Design custom Cross-Action Capsulorhexis Forceps and we will manufacture them for you!

1. Choose the Tip you prefer:

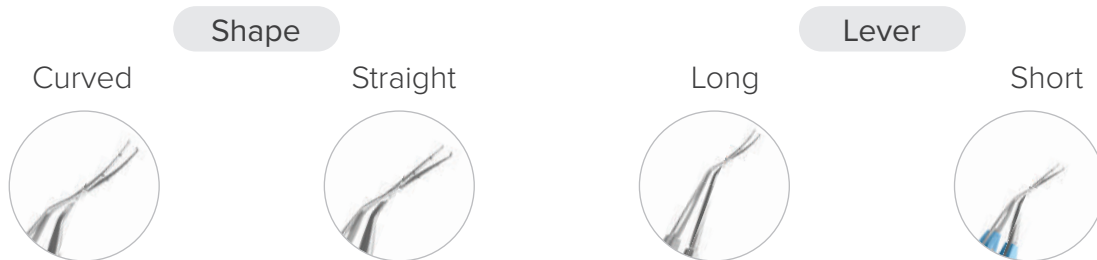

2. Complete with the Handle:

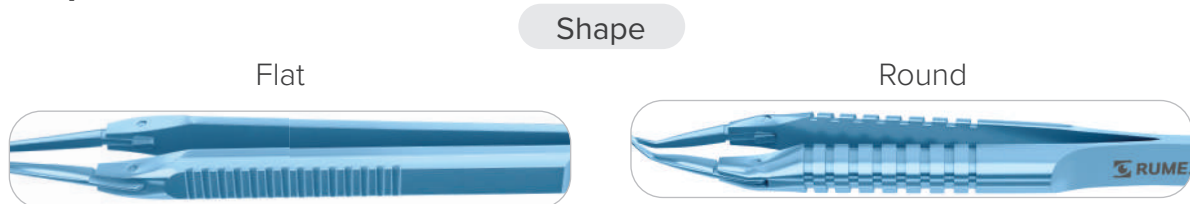

	Short		71 mm
Size	Medium		91 mm
	Long		101 mm

3. Select the Material:

All Tips and Handles are available in Titanium and Stainless Steel!

Product design and/or features that do not influence its functionality and main parameters are subject to change

CROSS-ACTION CAPSULORHEXIS FORCEPS ONLINE CUSTOMIZER

NEW

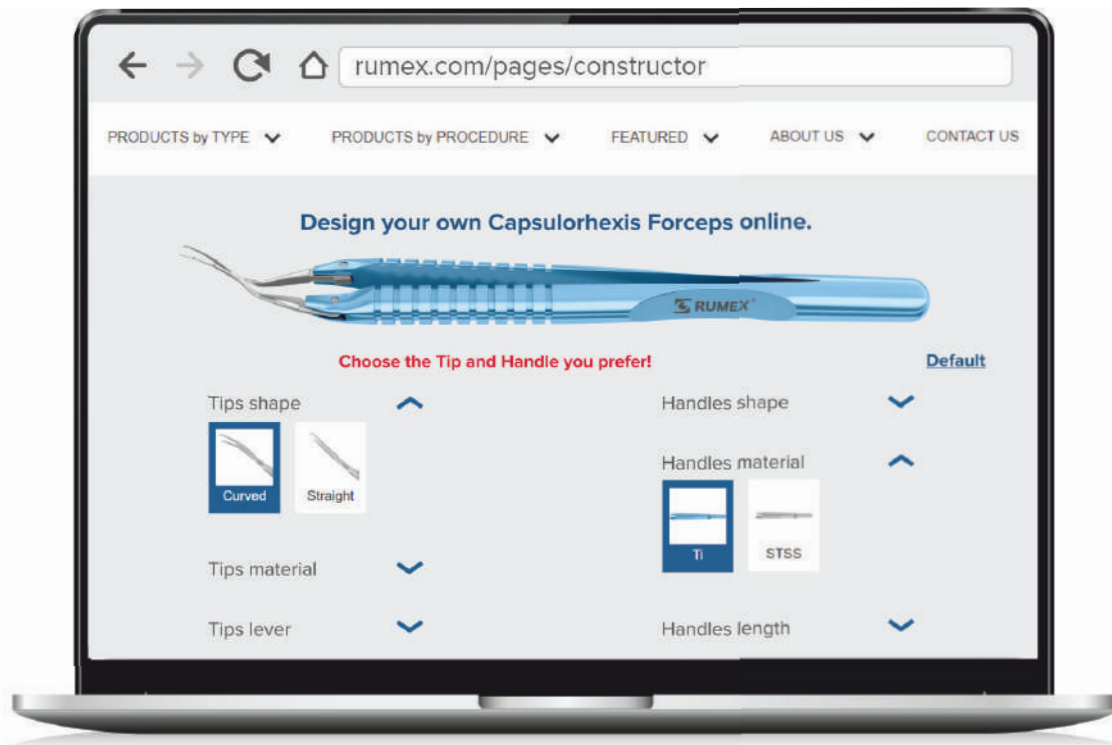

Create your own unique instrument!

Choose sizes, shapes, and materials that you prefer.
Curved or Straight, Long or Short, Titanium or Stainless Steel up to your preferences.
You can modify the tool with a few clicks!



72 variants are available! You design, we create!

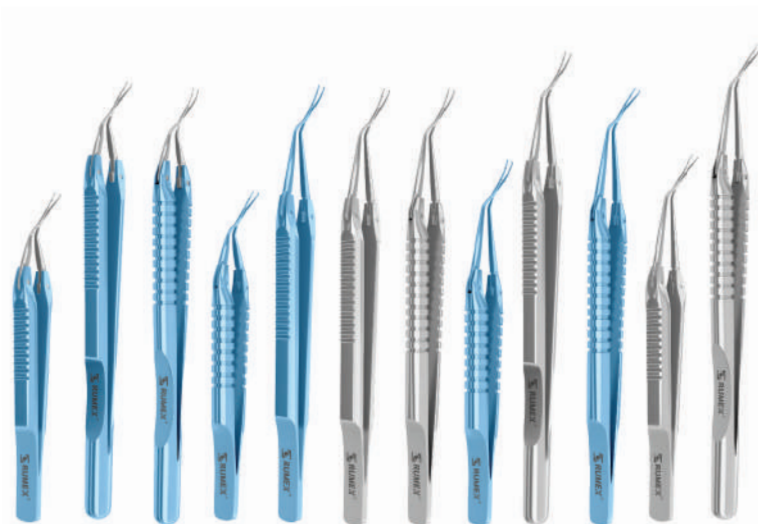

MICS CAPSULORHEXIS FORCEPS

Micro jaws, 0.80 mm incision

Exquisite gripping function

Anti-glare matte finishing

Stiff and flexible Stainless Steel tube

Kershner One-Pinch Capsulorhexis Forceps

Curved shaft
Cystotome tips
With fixation wheel
Compatible with Squeeze Handle 12-003T



4-03731* 23 Ga
For high vacuum phaco



4-03741* 23 Ga **POPULAR**
Micro jaws
Reduced length of the
branches for better
maneuverability in the anterior
chamber during capsulorhexis

Capsulorhexis Forceps with Micro Jaws and Internal Ruler

The internal laser marks allow to measure
the size of rhexis.
Curved shaft
Cystotome tips
With fixation wheel
Compatible with Squeeze Handle 12-003T

4-0374* 23 Ga
2 engravings at 3,6 mm

4-0375* 23 Ga
6 engravings at 1,2,3,4,5,6 mm



4-0374



4-0375

Lesieur

Capsulorhexis Forceps with Internal Ruler
Shorter jaws facilitate gripping the capsule
close to the wound.
Gently curved and short shaft for better
maneuverability in the anterior chamber.
7 engravings at 1,2,2.5,3,4,5,6 mm
for perfect sizing of the rhexis
Cystotome tips
With fixation wheel
Compatible with Squeeze Handle 12-003T

4-03742* 23 Ga

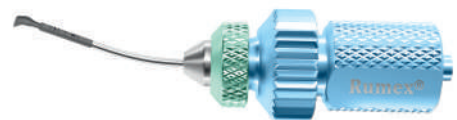

*Tip only. Handles are sold separately.

Product design and/or features that do not influence its functionality and main parameters are subject to change

**Ikeda
Capsulorhexis Forceps**

Curved shaft
Reduced length of the branches for better maneuverability in the anterior chamber during capsulorhexis
Cystotome tips
With fixation wheel
Compatible with Squeeze Handle 12-003T

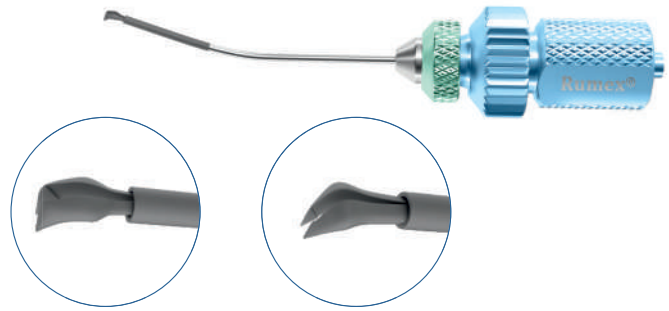

Fine-Ikeda
Capsulorhexis
Forceps with Micro
Jaws, 23 Ga

4-03751* 23 Ga

Ikeda Micro
Capsulorhexis Forceps, 23
Ga

4-03761* 23 Ga

**Kawai
Capsulorhexis Forceps**

Curved tapered elongated 23/25 Ga shaft
The construction of the forceps shows least adverse effect on the wound.
Gripping tips are projected out of 25 Ga shaft.
Cystotome tips
With fixation wheel
Compatible with Squeeze Handle 12-003T

4-03771* 23/25 Ga

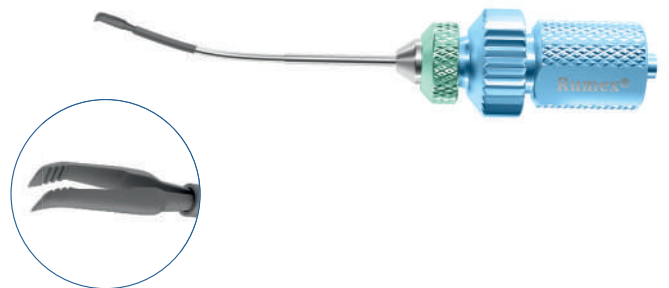

**Capsulorhexis Forceps
with View Port**

7 engravings at 1,2,2.5,3,4,5,6 mm for perfect sizing of the rhexis
Reduced length, gently curved tube
Cystotome tips
With fixation wheel
Compatible with Squeeze Handle 12-003T

4-03791* 23 Ga

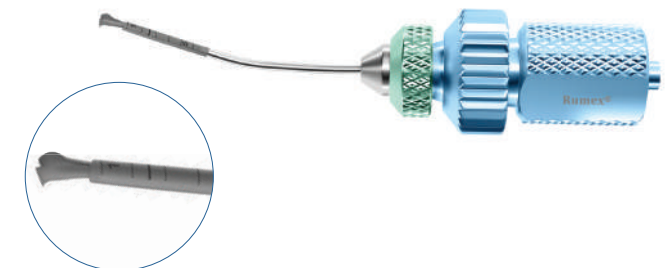

FORCEPS FOR LASER-ASSISTED SURGERY

**Forceps for Femtosecond Laser
Cataract Procedure**

Special blunt-ended tips
Cross-action facilitates quick and safe incision opening.
Ultrathin delicate tips are safe for the wound edges.
Flat handle
Overall length 108 mm
Stainless Steel

4-0582S



*Tip only. Handles are sold separately.
Product design and/or features that do not influence its functionality and main parameters are subject to change

CILIA FORCEPS

Cilia

Smooth jaws
Flat handle

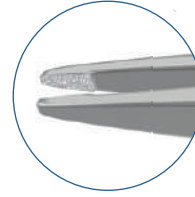
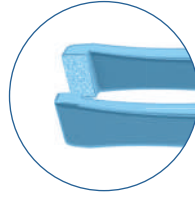

Wide forceps
Overall length 85 mm
Titanium

4-043T **POPULAR**

Narrow forceps
Overall length 86 mm

4-042T Titanium **POPULAR**
4-042S Stainless Steel

CONJUNCTIVA FORCEPS

Fechtner Conjunctiva Forceps

Delicate ring tip jaws
Flat handle
Overall length 108 mm
Titanium

4-2301T **POPULAR**

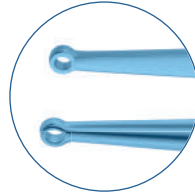

A-2301S
SS

LID AND CHALASION FORCEPS

Desmarres Chalazion Forceps

Solid lower plate, open upper plate
Locking thumb screw mechanism
Flat handle
Overall length 96/90/92 mm
Titanium

4-1906T Large size 31.00×17.40 mm (shown)
4-1907T Small size 19.80×10.40 mm
4-1912T Medium size 24.00×16.00 mm

POPULAR
POPULAR
POPULAR



CHALAZION
p.166

4-1907S
SS

4-1912S
SS

Lambert Chalazion Forceps

Round solid lower plate, open upper plate
Locking thumb screw mechanism
Flat handle
Overall length 92/97 mm
Titanium

4-1908T Small, 8.00 mm ID of the upper plate
4-1909T Medium, 12.00 mm ID of the upper plate (shown)

POPULAR
POPULAR



CHALAZION
p.166

4-1908S
SS

4-1909S
SS

Putterman Lid Clamp

6 Pins
Serrated jaws
Sliding lock
Overall length 100 mm
Titanium

4-140T **POPULAR**



LID
p.168

OCULOPLASTIC
p.170

Product design and/or features that do not influence its functionality and main parameters are subject to change

COMPRESSING LID FORCEPS

Dysfunctional meibomian glands often cause dry eyes. They may also contribute to blepharitis. Physical expression of the blocked glands has the goal of removing gland obstruction.

Compressing Lid Forceps

Designed for mechanical meibum removal.
Curved
Flat handle
Overall length 112 mm
Titanium

4-1913T **POPULAR**

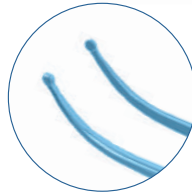

LID
p.168

Obtains quick and delicate meibum expression by equal compressing of the eyelid from the internal and external sides.

Compressing Lid Forceps with Atraumatic Rollers

Designed for mechanical meibum removal.
Flat handle
Overall length 107 mm
Stainless Steel

4-124S **POPULAR**

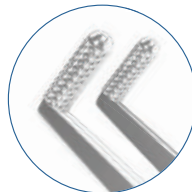

LID
p.168

Texturized rollers are safe for the conjunctiva. Quick and delicate meibum expression is achieved by even squeezing of the eyelid from its base to the margin.

LASIK FLAP FORCEPS

LASIK Flap Forceps

Specially designed for LASIK.
For atraumatic corneal flap lifting and holding
Blunt, circle-shaped tips
Criss-cross serrations on the jaws
Curved shafts
Flat handle
Overall length 108 mm
Titanium

4-2206T

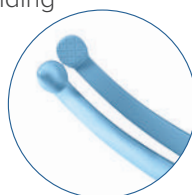

FEMTOLASIK
p.159

LASIK
p.159

4 - FORCEPS

SMILE FORCEPSSMILE
p.158**Cross-Action SMILE Forceps**

Cross-action prevents the hyperextension of the incision. Serrated jaw facilitates gripping of the lenticule during SMILE procedure. Flat handle Overall length 120 mm

4-0398

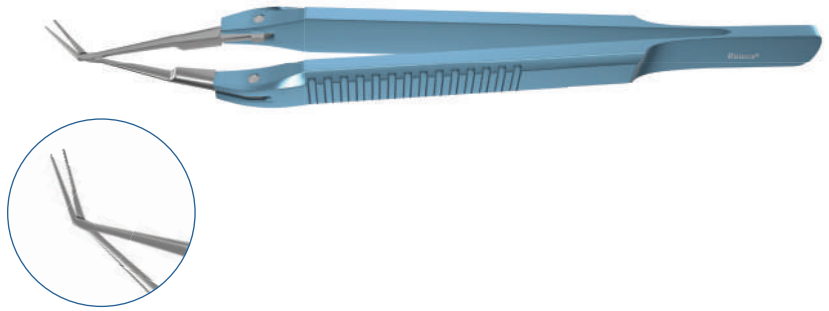
**Stodulka Forceps for Small-Incision Lenticule Extraction**

Designed to grasp the lenticule and remove it from the corneal pocket. Composite surface of the tips (texturized and serrated) ensures the efficient grasping of the lenticule. Angled Flat handle Overall length 100 mm Stainless Steel

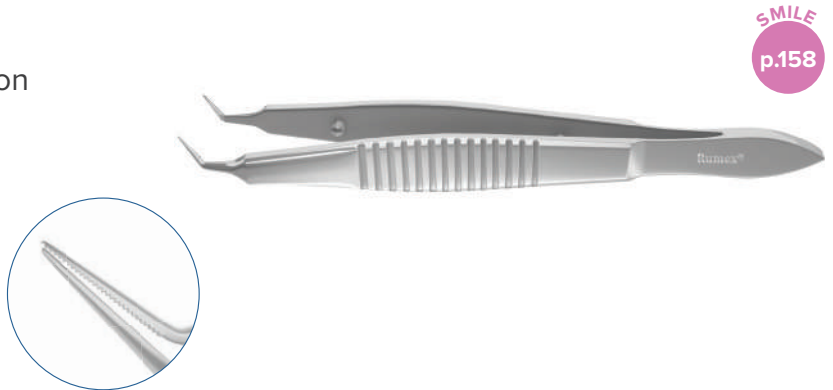
4-2012S **POPULAR**SMILE
p.158**SMILE Lenticule Extraction Forceps with a View-Port****NEW**SMILE
p.158

Designed to grasp the lenticule and remove it from the corneal pocket. Wide gripping area and atraumatic flattened tips for easy and safe manipulations Curved shafts adhere to the curvature of the cornea. View-port for enhanced visualization Overall length 106 mm Stainless Steel

4-266S

**SMILE Lenticule Extraction Forceps with Serrations****NEW**SMILE
p.158

Designed to grasp the lenticule and remove it from the corneal pocket. Ultrathin tips are safe for the pocket walls. Composite surface of the tips (texturized and serrated) ensures the efficient grasping of the lenticule. Overall length 84 mm Stainless Steel

4-268S



ICRS FORCEPS

Forceps for ICRS Implantation

0.20 mm 1x1 teeth
 0.30 mm groove
 Flat handle
 Overall length 85 mm
 Titanium
 4-2144T

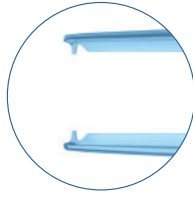

CORNEAL FORCEPS

Tungsten carbide coated platform for an even greater grip and increased control

Colibri Corneal Forceps

5.00 mm tying platform
 Flat handle

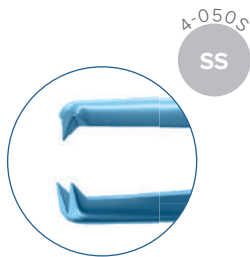

Colibri
 1x2 teeth 0.12 mm
 Titanium
 Overall length 84 mm
 4-050T **POPULAR**



Colibri-Bonn
 1x2 teeth 0.12 mm
 Titanium
 Overall length 77 mm
 4-0504T **POPULAR**

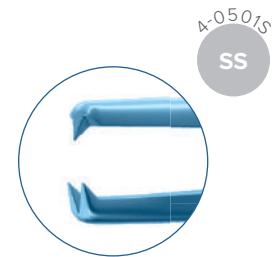

Colibri
 1x2 teeth 0.12 mm
 Titanium
 Overall length 77 mm
 4-0501T **POPULAR**



Micro Colibri
 1x2 teeth 0.12 mm
 Titanium
 Overall length 73 mm
 4-0505T **POPULAR**

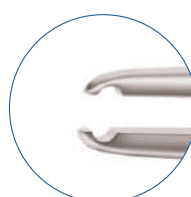

Hoskin Colibri
 Pierced tips
 Stainless Steel
 Overall length 84 mm
 4-0502S

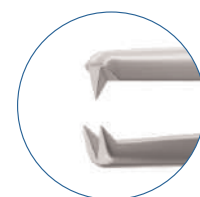

Colibri-Bonn
 1x2 teeth 0.12 mm
 Stainless Steel
 Overall length 84 mm
 4-0503S **POPULAR**

Tungsten carbide coated platform for an even greater grip and increased control

Colibri Corneal Forceps

Bonn type 1x2 teeth, 0.12 mm
Tying platform, 5.00 mm
Flat handle
Overall length 115 mm
Titanium

4-053T

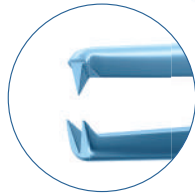

Castroviejo Colibri Corneal Forceps

1.2 teeth, 0.12 mm
Tying platform, 5.00 mm
Flat handle
Overall length 107 mm
Titanium

4-0541T

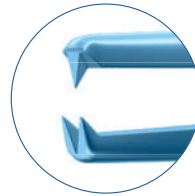

Colibri Corneal Forceps

1x2 teeth, 0.12 mm
Tying platform, 5.00 mm
Round handle
Overall length 109 mm
Titanium

4-054T Regular tips

4-0540T Bonn type tips

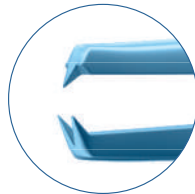

4-054T

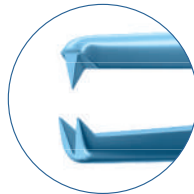

4-0540T

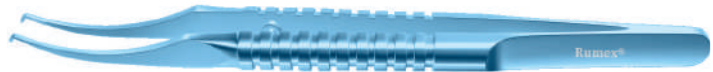

Corneal Forceps

5.00 mm tying platform
Titanium



Catalano

Round handle
Overall length 105 mm

1x2 teeth 0.12 mm

4-055T **POPULAR**

A-055S
SS



1x2 teeth 0.30 mm

4-056T

1x2 teeth 0.50 mm

4-057T

Bonn-Catalano

1x2 teeth 0.12 mm
Round handle
Overall length 105 mm

4-0551T **POPULAR**

A-0551D
SS

A-0551S
SS



Bonn

1x2 teeth 0.12 mm
Flat handle
Overall length 94 mm
Medium size

4-058T **POPULAR**

A-058S
SS

Bonn

1x2 teeth 0.12 mm
Flat handle
Overall length 72 mm
Small size

4-059T

CORNEAL TRANSPLANTATION FORCEPS

Florakis Endothelial Forceps

Designed to assist in the removal of endothelium from the host cornea.
 Reversed triangular tips, angled 75°
 Flat handle
 Overall length 103 mm
 Stainless Steel

4-246S



Corneal Donor Insertion Forceps

Designed for atraumatic insertion of the donor lamella folded in a taco shape.
 30° angled, 18.00 mm tip
 Round handle
 Overall length 125 mm
 Titanium

4-2019T



Florakis Microinvasive Endothelial Forceps

Designed to assist in the removal of endothelium from the host cornea.
 With fixation wheel
 Compatible with Squeeze Handle 12-003T

4-247* 23 Ga



Forceps for Corneal Endothelium Implantation

For inserting the donor button with the pull-through technique
 Provides for security of corneal stromal layer.
 Compatible with Squeeze Handle 12-003T

Can be used for SMILE lenticule extraction.

4-034* 23 Ga



Guell DMEK Forceps

Highly polished broad tips allow to peel the endothelial membrane safely without risk of tearing.
 Overall length 103 mm
 Stainless Steel

4-240



*Tip only. Handles are sold separately.
 Product design and/or features that do not influence its functionality and main parameters are subject to change

4 - FORCEPS

Cross-Action DMEK Forceps

Overall length 110 mm

- 4-251 Flat Titanium handle
- 4-262 Round Titanium handle
- 4-262S Flat Stainless Steel handle

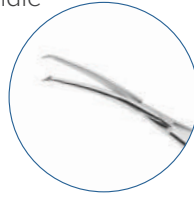

Reversed tips are used to peel off the Descemet's membrane through a 1.80 mm incision.

Lambright-Abdullayev Ultrathin DSAEK Grasping/Inserting Forceps

Flat handle
Overall length 105 mm
Stainless Steel

4-254S

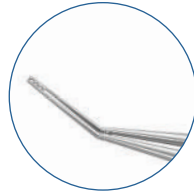

Designed to improve insertion of the ultrathin DSAEK grafts especially with thickness 70 microns and less. Space between the tips is 120 microns to minimize compression and provide more safety for donor endothelial cells. Wave-shaped serration of grasping platforms on tips for nonslip insertion while allowing atraumatic forceps removal.

Abdullayev DMEK Grasping Forceps

Flat handle
Overall length 82 mm
Stainless Steel

4-261S



Improved angle between grasping platform, the rest of the forceps allows relaxing hand position and more control when in use. Horizontal thin grasping platforms provide more stability in membrane holding during separation.

DRESSING FORCEPS

Dressing Forceps with Delicate Serrations

Straight serrated tips, 6.00 mm
Round handle
Overall length 108 mm
Stainless Steel

4-070S **POPULAR**

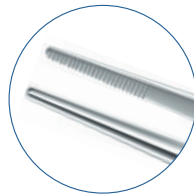

Dressing Forceps with Delicate Serrations

Serrated tips, 12.00 mm
Flat handle
Overall length 100 mm
Stainless Steel or Titanium

- 4-071S Straight **POPULAR**
- 4-072T Curved

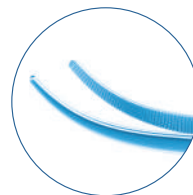
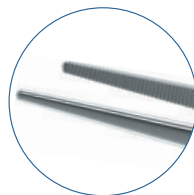

4-071S

4-072T

FIXATION FORCEPS

Adson Fixation Forceps with Teeth

Ideal for plastic & reconstructive surgery
Flat handle
Overall length 124 mm
Stainless Steel or Titanium

- 4-0741S 1x2 teeth, 0.50 mm **POPULAR**
- 4-0741T 1x2 teeth, 0.50 mm
- 4-0740T Serrated tip
- 4-0740S Serrated tip

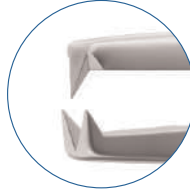

4-0741S

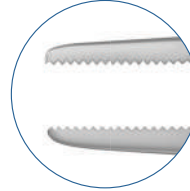

4-0740S

CORNEAL p.161
DLEK p.163

Polack Corneal Transplant Fixation Forceps

Two point fixation
Delicate 1x2 teeth, 0.12 mm
1.20 mm between the tips
Curved shafts
Pierce type tips
Round handle
Overall length 112 mm
Titanium

- 4-0814T **POPULAR**

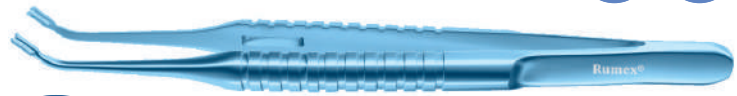

Nevyas-Wallace Fixation Forceps

Two point fixation
13.00 mm between the ends
1x2 teeth, 0.12 mm
Straight shafts
Round handle
Overall length 105 mm
Titanium

- 4-08011T

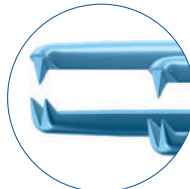
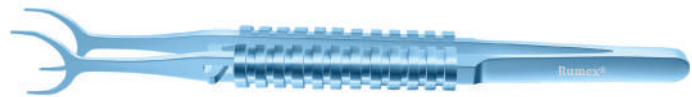

Castroviejo Fixation Forceps

Straight shafts
1x2 teeth, 0.50 mm
Flat handle
Overall length 109 mm
Titanium

- 4-0822T **POPULAR**



Lester Fixation Forceps

Straight tips
6.00 mm platforms
2x3 teeth
Flat handle
Overall length 105 mm
Stainless Steel

- 4-0832S

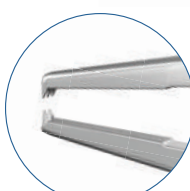

LENS INSERTERS

Steinert Paddle Lens Folding Forceps

Angled shafts
Flat handle
Overall length 110 mm
Titanium
4-2107T

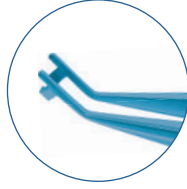

PHACO p.154
ECCE p.156
A-2107S
SS

Faulkner Lens Holding Forceps

Angled shafts
Smooth jaws
Flat handle
Overall length 105 mm
Stainless Steel
4-2108S **POPULAR**

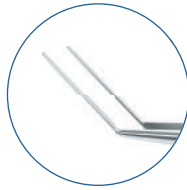

McDonald Inserting Forceps for Silicone Lens

Concave jaws, 5.00 mm
Cross-action
Flat handle
Overall length 107 mm
Stainless Steel
4-2113S

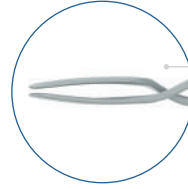
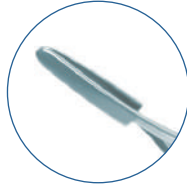

topside view



ECCE
p.156

Acrylic Lens Insertion Forceps

Flat handle
Overall length 105 mm
Titanium
4-2132T **POPULAR**



A-2132S
SS

Akahoshi Forceps for Acrylic Lens

Thin and smooth jaws, 7.00 mm
Jaws open up to 5.50 mm
Cross-action
Flat handle
Overall length 108 mm
Titanium
4-2138T

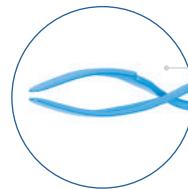
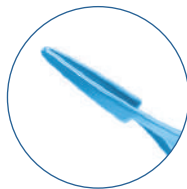

topside view



Cartridge Loading Forceps

Designed for inserting Acrylic IOL into A, B, C, D cartridges.
To be used with **16-2806, 16-2807, 16-2808 Injectors.**

Smooth jaws
Flat handle
Overall length 109 mm
Titanium

4-2141T

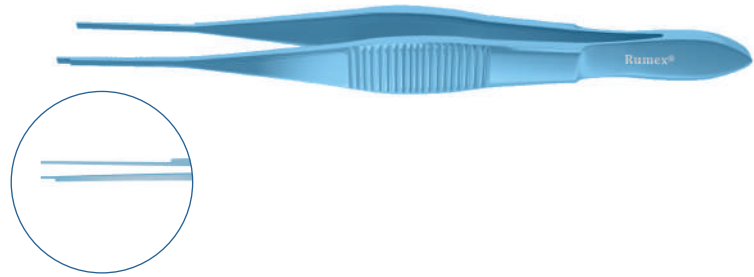

ARTISAN® Implantation Forceps

Used for implantation of toric ARTISAN® IOL.
Specially designed jaws help to fixate the lens optic during the enclavation.

Flat handle
Overall length 100 mm
Titanium

4-260T

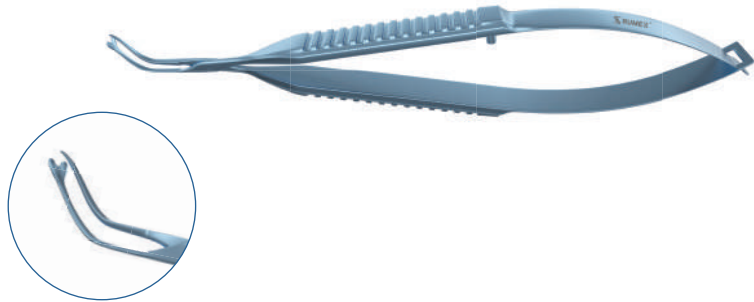

IOL REMOVING INSTRUMENTS

IOL Grasping Forceps

Designed to reach and hold the IOL optic and haptic.
Curved shaft
Sand-blasted surfaces for efficient gripping
Fenestrated jaws for better visualization and haptic manipulation
With fixation wheel
Compatible with Squeeze Handle 12-003T

4-2145* 21 Ga



Rowen Rescue Kit for Foldable Lens Removal

Rowen Rescue Kit Forceps

Crocodile type intraocular forceps for foldable lens removal
To remove silicone or acrylic IOL in case of complications
Curved shaft
Compatible with Squeeze Handle 12-003T

4-2150* 19 Ga **POPULAR**

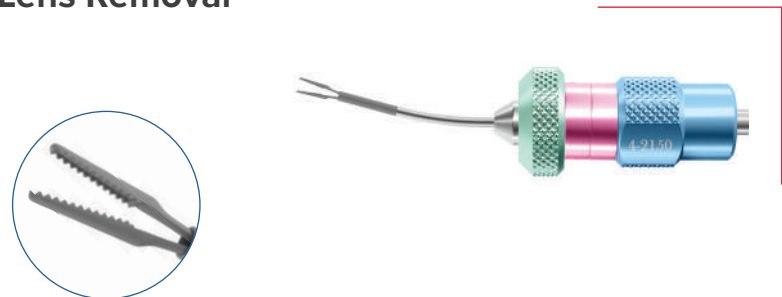

Rowen Rescue Kit Scissors

Intraocular scissors for foldable lens removal
To remove silicone or acrylic IOL in case of complications
Curved shaft
Compatible with Squeeze Handle 12-003T

4-2151* 18 Ga **POPULAR**



*Tip only. Handles are sold separately.

Product design and/or features that do not influence its functionality and main parameters are subject to change

Micro Foldable Lens Cutter

Intraocular scissors for foldable lens removal
To remove silicone or acrylic IOL in case of complications
Blades with notches
Curved shaft
Compatible with Squeeze Handle 12-003T
4-2173* 19 Ga

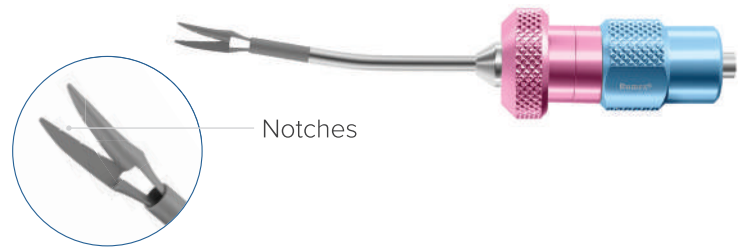

RUMEX Foldable Lens Cutter

Designed to cut and remove all types of foldable intraocular lenses through a small incision.
Upper blade of the scissors has three bevels for effective cutting and grasping of the IOL.
Flat squeeze Titanium handle
Overall length 113 mm

4-21731 **POPULAR**



RUMEX Foldable Lens Removing Forceps

Designed to grasp and remove all types of foldable intraocular lenses through a small incision.
Flat squeeze Titanium handle
Overall length 114 mm

4-21741 **POPULAR**



Osher IOL Scissors

To cut silicone or acrylic IOL in case of complications
8.50 mm blades with serrations to fixate the lens
Flat handle
Overall length 91 mm
Stainless Steel

4-2175S **POPULAR**



*Tip only. Handles are sold separately.

Product design and/or features that do not influence its functionality and main parameters are subject to change

ICL FORCEPS

ICL™ Cartridge Loading Forceps

Designed to remove the ICL from the container and push it inside the cartridge.
Angled 30° long jaws
Round handle
Overall length 120 mm

4-20111T Titanium
4-20111S Stainless Steel

ICL™ - registered trademark of STAAR®

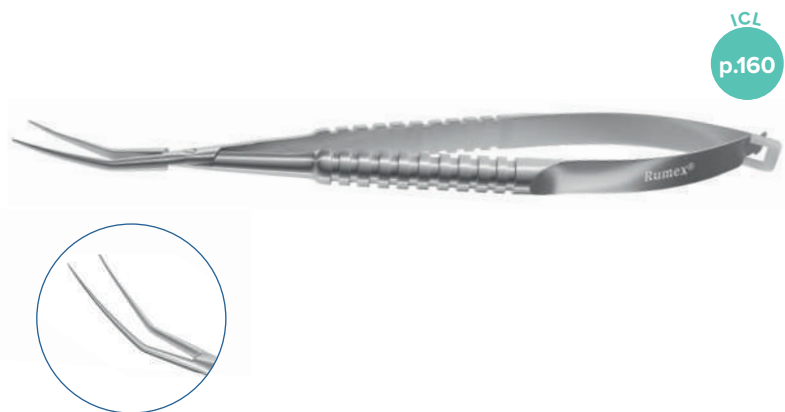

ICL™ Coaxial Angled ICL™ Loading Forceps

Designed to load the ICL™ inside the cartridge to ensure proper positioning by pulling from the distal opening.

Straight shaft
Non rotatable
With fixation wheel
Compatible with Squeeze Handle 12-003T

4-21431* 20 Ga

ICL™ - registered trademark of STAAR®



Zaldivar-Kraff ICL™ Pacman Forceps

Designed to load the ICL™ inside the cartridge to ensure proper positioning by pulling from the distal opening.

Atraumatic ridges and the gentle curve at the tips to grasp the ICL® without damage.
Straight shaft, angled tips
With fixation wheel
Compatible with Squeeze Handle 12-003T

4-21432* 20 Ga

ICL™ - registered trademark of STAAR®

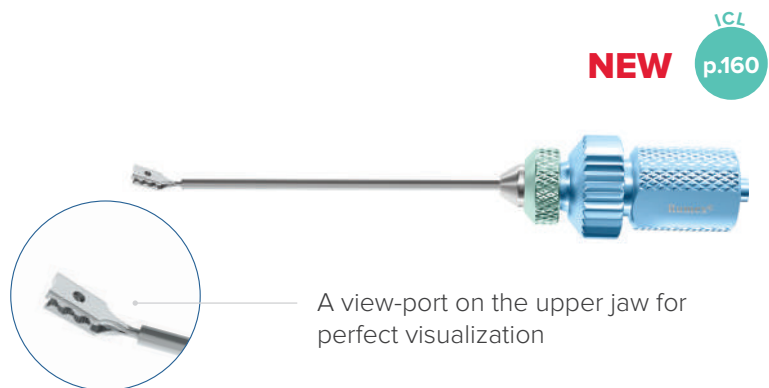

*Tip only. Handles are sold separately.

Product design and/or features that do not influence its functionality and main parameters are subject to change

IRIS FORCEPS

Iris Forceps

Flat handle
Overall length 72 mm
Stainless Steel

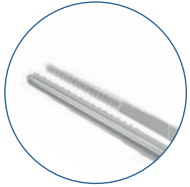

Straight shafts
Fine serrated tips
Delicate serrations
4-100S

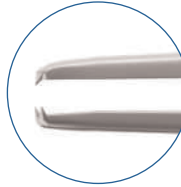

1x2 Delicate teeth, 0.06 mm
4-101S Straight shaft (shown) **POPULAR**
4-102S Curved shaft

JEWELER FORCEPS

Jeweler #5 Forceps

Pointed tips
Tying platform 6.00 mm
Straight jaws
Flat handle
Overall length 110 mm
Titanium

4-111T **POPULAR**

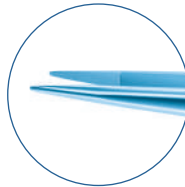

Jeweler #3C Forceps

Pointed tips
Tying platform 6.00 mm
Straight jaws
Flat handle
Overall length 110 mm
Titanium

4-113T **POPULAR**

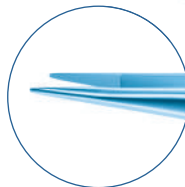

Jeweler #7 Forceps

Pointed tips
Tying platform 6.00 mm
Curved jaws
Flat handle
Overall length 110 mm
Titanium

4-115T

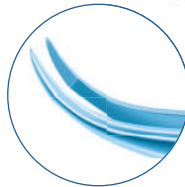

HEMOSTATIC FORCEPS AND SERREFINES

Hartman Hemostatic Mosquito Forceps

Serrated jaws
Ring handle
Overall length 90 mm
Stainless Steel

4-120S Straight (shown) **POPULAR**
4-121S Curved



Halsted Hemostatic Mosquito Forceps

Serrated jaws
Ring handle
Overall length 125 mm
Stainless Steel

4-122S Straight (shown) **POPULAR**
4-123S Curved

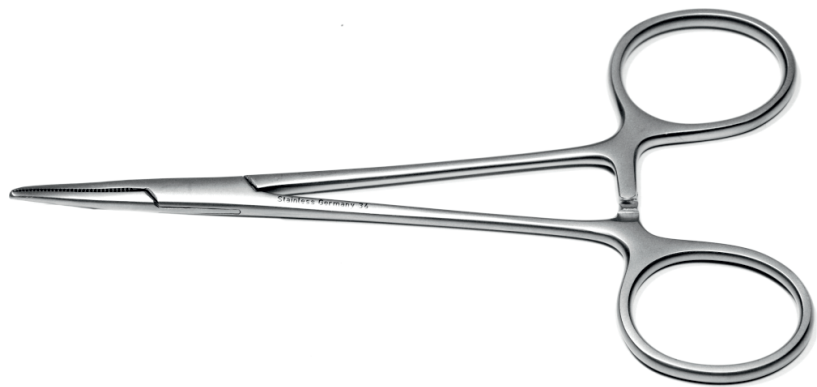

Serrefine

Straight
Stainless Steel

16-090S Large size **POPULAR**
Overall length 55

16-092S Small size
Overall length 35



MUSCLE FORCEPS

Jameson Muscle Forceps

11.00 mm from tip to angle
6.00 teeth
Slide lock
Overall length 100 mm
Stainless Steel

4-130S Left **POPULAR**
4-131S Right (shown) **POPULAR**



MUSCLE
p.169

4 - FORCEPS

Superior Rectus Forceps

1x2 teeth, 0.50 mm
Flat handle

Osher

Angled shafts
10.00 mm from tip to angle
Overall length 106 mm
Stainless Steel

4-136S

Elsching

Straight shafts
Overall length 108 mm
Titanium

4-138T



MUSCLE
p.169

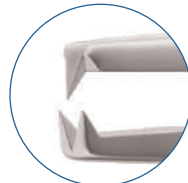

4-136S



4-138T

A-0600D
2

SUTURING FORCEPS

Tying platform hard-faced with tungsten carbide coating for even greater grip and increased control over the tissue and suturing materials

Castroviejo
Suturing Forceps

Tying platform, 6.00 mm
Flat handle
Overall length 110/108/108 mm

4-0600T 1x2 teeth, 0.12 mm
4-0601T 1x2 teeth, 0.30 mm
4-0602T 1x2 teeth, 0.50 mm

POPULAR

Titanium or Stainless Steel



A-0600S
SS

A-0601S
SS

A-0602S
SS

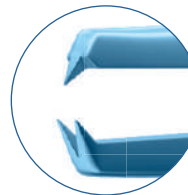
Paufigue
Suturing Forceps

1x2 teeth, 0.50 mm
Tying platform, 6.00 mm
Flat handle
Overall length 87 mm

4-0606T Titanium



A-0606S
SS

Bishop-Harmon
Suturing Forceps

1x2 teeth, 0.30 mm
Tying platform, 5.00 mm
Flat handle
Overall length 87 mm
Stainless Steel

4-0607S POPULAR

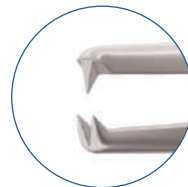
Moorfields
Suturing Forceps

For gripping the tissue, conjunctiva
and Tenon's capsule
Grooved section, 14.00 mm
Flat handle
Overall length 110 mm
Titanium

4-2303T POPULAR

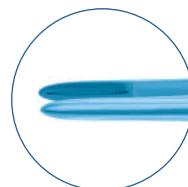

TYING FORCEPS

Tying platform hard-faced with tungsten carbide coating for even greater grip and increased control over both tissue and suturing equipment

Kelman-McPherson Tying Forceps

For 8-0 to 11-0 sutures
Flat handle

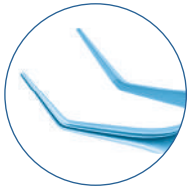

Tying platforms, 4.00 mm
Overall length 81 mm
Titanium

4-090T **POPULAR**

Tying platforms, 10.00 mm
Overall length 86 mm
Titanium

4-092T **POPULAR**

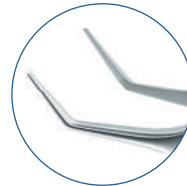

Tying platforms, 8.00 mm
Overall length 84 mm
Stainless Steel

4-091S **POPULAR**

Tying platforms, 10.00 mm
Overall length 86 mm
Stainless Steel

4-092S

McPherson Tying Forceps

For 8-0 to 11-0 sutures
Flat handle

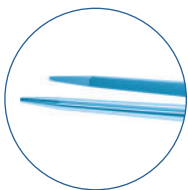

Straight
Tying platforms, 4.00 mm
Overall length 84 mm

4-171T Titanium (shown)
4-171S Stainless Steel

POPULAR

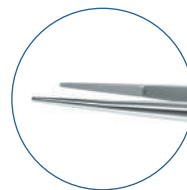

Straight
Tying platforms 7.00 mm
Overall length 110 mm
Stainless Steel

4-178S **POPULAR**

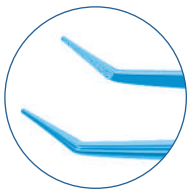

Angled, Titanium
Tying platform, 6.00 mm
Overall length 102 mm

4-173T **POPULAR**

Tying platform, 8.00 mm
Overall length 103 mm

4-174T **POPULAR**

Tying platform, 10.00 mm
Overall length 104 mm

4-175T **POPULAR**

Tying platform, 12.00 mm
Overall length 106 mm

4-176T **POPULAR**

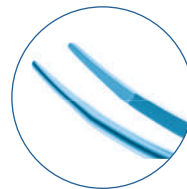

Curved
Tying platforms, 4.00 mm
Overall length 109 mm
Titanium

4-177T **POPULAR**

Catalano Tying Forceps

For 8-0 to 11-0 sutures
Curved
V-groove tying platform, 6.00 mm
Round handle
Overall length 106 mm
Titanium

4-182T

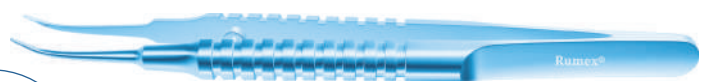
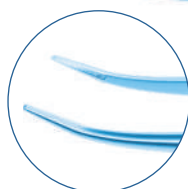

Product design and/or features that do not influence its functionality and main parameters are subject to change

4 - FORCEPS

Typing platform hard-faced with tungsten carbide coating for even greater grip and increased control over both tissue and suturing equipment

Tennant Tying Forceps

For 9-0 to 11-0 sutures

Extra delicate smooth jaws
Typing platform, 6.00 mm
Round handle
Overall length 108/107/107 mm
Titanium or Stainless Steel

4-185T Straight (shown) **POPULAR**

4-185S Straight **POPULAR**

4-1851T Angled **POPULAR**

4-186S Curved **POPULAR**

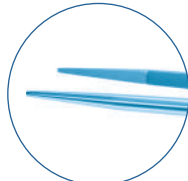

4-185T

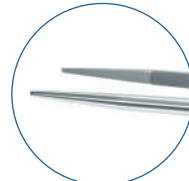

4-185S

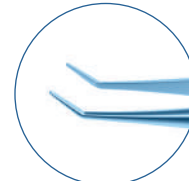

4-1851T



4-186S

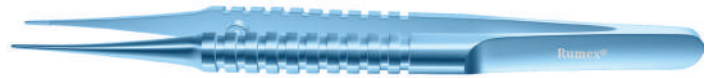

Intraocular Tying Forceps

For 9.0-11.0 sutures

Designed for intraocular suturing.
With fixation wheel
Compatible with Squeeze Handle
12-003T

4-1891* 23 Ga

**MICS**

UTILITY FORCEPS

Bonaccolto
Utility Forceps

Longitudinal atraumatic serrations, 15.00 mm
Cross serrations at tips
Flat handle
Overall length 100 mm
Titanium **POPULAR**

4-2300T

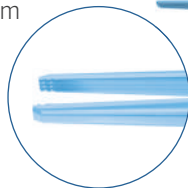
4-2300S
SSWatzke
Sleeve Spreading Forceps

Used to stretch the silicone sleeve placed
around the eyeball.
Serrated tips aid in gripping the sleeve and
allow for adjustable traction.

Flat cross-action handle
Overall length 110 mm
Titanium

4-2201T



TOWEL CLAMPS AND FORCEPS

Schaedel
Towel Clamp

Flat handle
Overall length 90 mm
Stainless Steel

16-080S

Towel Forceps

Ring handle
Overall length 125 mm
Stainless Steel

16-081S **POPULAR**

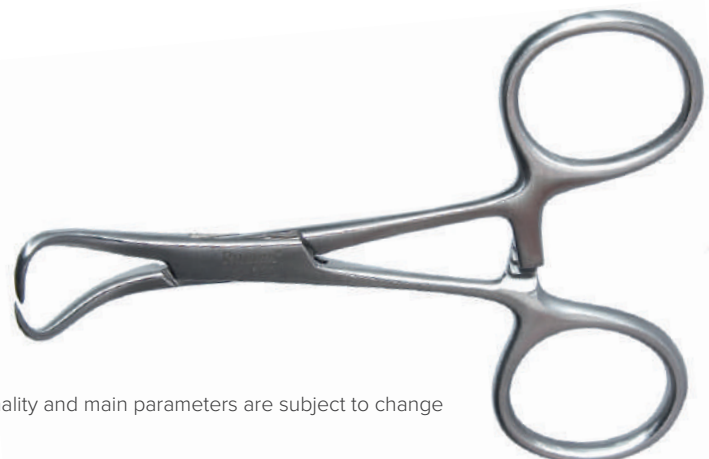

*Tip only. Handles are sold separately.

Product design and/or features that do not influence its functionality and main parameters are subject to change

HOOKS

INTRAOCULAR LENS HOOKS

Stainless Steel hooks with an ergonomic light-weight round Titanium handle



Lewicky Lens Manipulating Hook

Angled, 10.00 mm from tip to angle
Vaulted shaft
0.15 mm diameter blunt tip
Overall length 120 mm

5-021



Kuglen Iris Hook and Lens Manipulator

0.15 mm diameter shaft
"H"-shaped tip
Overall length 122/124 mm

5-030 Angled **POPULAR**
5-0301 Straight



RUMEX Lens Manipulator

Angled, 10.00 mm from tip to angle
0.18 mm diameter shaft
Button-shaped 0.45 mm tip
Overall length 122 mm

5-031 **POPULAR**



Sinskey Lens Manipulating Hook

Angled
0.15 mm diameter tip
Overall length 121/122 mm

5-032 Angled **POPULAR**
5-0321 Straight



Reversed Sinskey Scoring Hook for Endothelial Keratoplasty

Angled, 10.00 mm from tip to angle
0.20 mm diameter tip
Overall length 117 mm

5-0322 **POPULAR**



Lester Lens Manipulator

Hourglass-shaped 0.20 mm tip
Overall length 124/122 mm

5-033 Straight
5-0331 Angled **POPULAR**

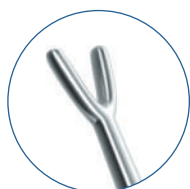

Bechert Nucleus Rotator

Angled, 10.00 mm from tip to angle
"Y"-shaped tip
Overall length 121 mm

5-034 **POPULAR**



Fenzl Lens Manipulating Hook

Angled, 10.00 mm from tip to angle
"T"-shaped tip
Overall length 121 mm

5-036

MUSCLE/TENOTOMY HOOKS

Stainless Steel hooks with an ergonomic light-weight flat serrated Titanium handle

Ensure safety of extraocular muscles

Jameson Muscle Hook

Flat hook
Bulbous tip

2.00 mm tip, 9.50 mm hook
Overall length 135 mm

5-040 Standard **POPULAR**

1.50 mm tip, 8.00 mm hook
Overall length 128 mm

5-0401 Small

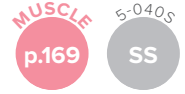

Graefe Muscle Hook

Flat hook

1.00 mm tip, 8.00 mm hook
Overall length 135 mm

5-041 Size 1 **POPULAR**

1.50 mm tip, 10.00 mm hook
Overall length 140 mm

5-042 Size 2 **POPULAR**



5 - HOOKS

MUSCLE
p.1695-061S
SS**Scobee
Oblique Muscle Hook**Curved shaft
4.50 mm flat hook
Overall length 136 mm5-061 **POPULAR**5-062S
SS**Stevens
Tenotomy Hook**6.00 mm flat hook
Overall length 120 mm5-062 **POPULAR****Rychwalski Muscle Hook
with Groove**1.80 mm tip
12.20 mm hook
Overall length 140 mm

5-046

**RETINAL DETACHMENT HOOKS**

Stainless Steel hook with an ergonomic light-weight flat serrated Titanium handle

**Gass
Retinal Detachment Hook**13.00 mm flat hook
1.50×0.70 mm hole
Overall length 140 mm5-060 **POPULAR****IRIS HOOKS****Iris Hook**1.00 mm
Angled
Overall length 121 mm

5-020

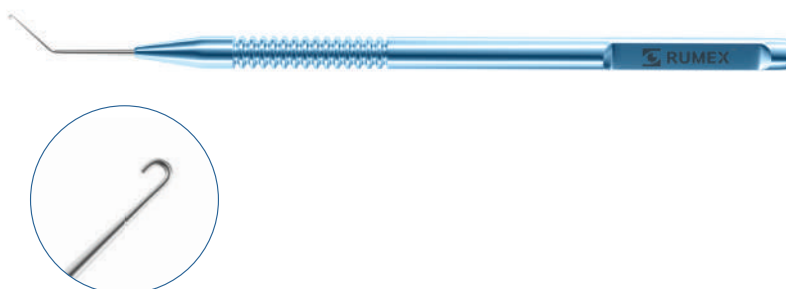

DIAMOND KNIVES

up to 3000
INCISIONS



Extreme sharpness of the blades

Potentially reduced risk of wound leak

Minimal pressure

Predictable cuts and architecture of the wound for more consistent healing

ASTIGMATIC KERATOTOMY AND ICRS

ICRS
p.163

ICRS Knife

Micrometer Titanium handle
Overall length 110 mm



ICRS

1.00 mm
Designed for implantation of intrastromal corneal ring segments (ICRS).
Performs a 1.00 mm radial incision at 70–80% of corneal thickness.
Micrometric scale allows to customize the depth of the blade
from 0 to 1000 microns (0 to 1.00 mm).
Increment – 5 microns (0.005 mm)
The maximal depth of the blade is 1700 microns (1.70 mm).

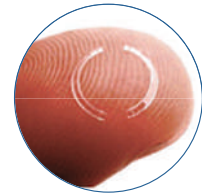
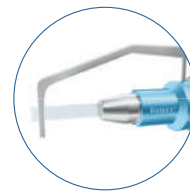

6-00/6-020 **POPULAR**

Arcuate

1.00/0.20 mm
Tapered blade
6-00/6-030



UNIVERSAL SIDE-PORT KNIVES

Used for paracentesis.
Straight Titanium handle
Overall length 120 mm



45° Single Edge
1.00 mm
6-10/6-050

45° Single Edge
0.60 mm
6-10/6-0501

30° Single Edge
1.00 mm
6-10/6-051

45° Double Edge
1.00 mm
6-10/6-052

Trifacet
1.00 mm
6-10/6-053 **POPULAR**



20° Trifacet
1.00 mm
6-10/6-0531

60° Lancet
1.00 mm
6-10/6-070

60° Lancet
0.80 mm
6-10/6-0701

Multi-Incision
1.00 mm
6-10/6-076



Product design and/or features that do not influence its functionality and main parameters are subject to change



ANGLED PHACO KNIVES

Used for tunnel incision.
Angled Titanium handle
Overall length 117 mm



GLAUCOMA
p.164

Clear Cornea Blades

- 6-20/6-071 – 2.50 mm
- 6-20/6-072 – 2.80 mm
- 6-20/6-073 – 3.00 mm
- 6-20/6-074 – 3.20 mm
- 6-20/6-075 – 2.20 mm
- 6-20/6-081 – 2.30 mm
- 6-20/6-077 – 2.75 mm
- 6-20/6-078 – 2.70 mm

Facet-Free Crescent Knives

- 6-20/6-091 – 1.50 mm
- 6-20/6-092 – 2.00 mm

PHACO
p.154

Self-Diving Trapezoid Blades

- 6-20/6-100 – 1.90/2.50 mm
- 6-20/6-101 – 2.70/3.20 mm
- 6-20/6-102 – 3.00/3.50 mm
- 6-20/6-104 – 2.30/2.80 mm
- 6-20/6-105 – 2.60/3.00 mm
- 6-20/6-107 – 2.00/2.30 mm

POPULAR



Profile of the incision directed

Used for micro incision.
Angled Titanium handle
Overall length 117 mm



ICL
p.160

Trapezoid Self-Diving Blades

- 6-20/6-140 – 0.50/1.00 mm
- 6-20/6-141 – 0.80/1.20 mm
- 6-20/6-142 – 1.30/1.50 mm
- 6-20/6-143 – 1.50/1.80 mm
- 6-20/6-144 – 1.80/2.00 mm
- 6-20/6-145 – 1.80/2.20 mm

MICS
p.155

Zaldivar Knife for ICL Implantation

0.55/1.00 mm
Designed for ICL™ implantation.
Can be used for other incisions:
side port, clear cornea, scleral tunnel.

6-20/6-0551 **POPULAR**



LRI KNIVES

LRI
p.160



Universal Three-Step Knife for Cataract and LRI Surgery

Precise, easy and stable calibration mechanism with 3 preset depths of 500, 550 and 600 microns. Full extension is for side-port incision. Overall length 125 mm



Single footplate for better visualization
20° Trifacet Blade
0.20 – 1.00 mm

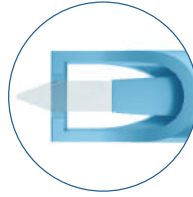

6-322/6-0531 **POPULAR**

Pre-Set LRI Knives

Pre-Set LRI Knives

Can be used with a slit lamp.
Short Titanium handle
Overall length 78 mm

6-500S/6-0531

Preset depth 500 microns

6-600S/6-0531

Preset depth 600 microns



Pre-Set LRI Knives

Long Titanium handle
Overall length 110 mm

6-500/6-0531

Preset depth 500 microns

6-600/6-0531

Preset depth 600 microns

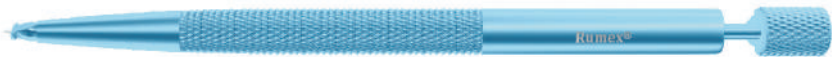

DON'T FORGET TO BUY

Diamond Knife Cleaning Pack

The pack consists of 3 solutions that are used to clean the blade from the residual debris prior to sterilization.

21-602-1



POPULAR

SAPPHIRE KNIVES

Low pressure

Accurate cuts

Consistent healing



UNIVERSAL SIDE-PORT KNIVES

Overall length 136 mm



45° Double Edge Blade
1.00 mm

6-10/6SK-0501



Trifacet Blade
1.00 mm

6-10/6SK-053

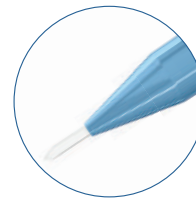

60° Double Edge Lancet Blade
1.00 mm

6-10/6SK-070 **POPULAR**

PHACO KNIVES

Overall length 135 mm



Clear Cornea Blades

6-20/6SK-072 – 2.80 mm

6-20/6SK-075 – 2.20 mm

6-20/6SK-080 – 2.65 mm

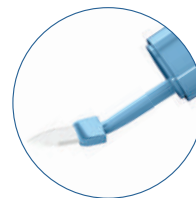

Self-Diving Trapezoid Blades

6-20/6SK-145 – 1.80/2.20 mm **POPULAR**

6-20/6SK-146 – 1.80/2.40 mm

6-20/6SK-147 – 1.80/2.90 mm



Facet-Free Crescent Blades

6-20/6SK-093 – 2.20 mm



Zaldivar Knife for ICL Implantation

6-20/6SK-0551 – 0.55/1.00 mm

PHACO INSTRUMENTS

Ernest Nucleus Cracker

Cross-action
Flat handle
Overall length 106 mm
Titanium

7-025T



Cross-action mechanism prevents the stretching of the wound

Serrated paddle shaped tips securely engage the nucleus

ECCE
p.156

PHACO
p.154



Kansas-Alfonso Nucleus Fragment Removing Forceps

Designed to remove fragments of the nucleus through a small incision.
2 rows of delicate teeth
Flat handle
Overall length 107 mm
Titanium

7-0201T

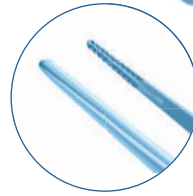

PRECHOPPERS

Cross-action
Ergonomic round serrated squeeze-handle
Stainless Steel



Angled Prechopper

Max opening 2.80 mm
Overall length 116 mm
7-111S



Inamura Prechopper

Straight
Narrow tip is easily inserted into the denser nucleus which enables division of a soft nucleus from a dense one without counter force.
Max opening 2.80 mm
Overall length 120 mm
7-1165S **POPULAR**



PHACO PRECHOP
p.155

Combo Prechopper

Straight
Specially designed jaws split soft and hard nuclei.
With sharp blades on the upper side of the tips and blunt on the other side
Max opening 2.80 mm
Overall length 121 mm
7-1161S **POPULAR**



Inamura Prechopper

Straight
Microincisional
Max opening 1.80 mm
Overall length 120 mm
7-11651S



Combo Prechopper

Straight
For sub-2.00 mm Coaxial Micro Phaco
Max opening 2.00 mm
Overall length 121 mm
7-1162S **POPULAR**



Yeoh Prechopper

Straight
Blunt atraumatic tips are used for complete nucleus separation during Femtosecond laser cataract procedure.
Max opening 2.00 mm
Overall length 120 mm
7-1166S



FEMTOCATARACT
p.157

Akahoshi Prechopper

Straight
Groove enables easy rotation of the nucleus during prechopping.
Max opening 2.80 mm
Overall length 121 mm
7-1163S **POPULAR**



NEW Crozafon Prechopper

Straight
Provides easy releasing of entrapped gas bubbles for safer hydrodissection.
Max opening 3.00 mm
Overall length 118 mm
7-1167S



FEMTOCATARACT
p.157

FEMTOCATARACT
p.157

NEW

Escaf Prechopper

Straight
Round handle
Overall length 120 mm
Stainless Steel
7-149S

Designed in cooperation with Luis Escaf MD, Colombia



Used to complete breakdown after Femtosecond or Ultrachopper and fracture cataract with hardness less than 4+. Tolerates capsulorhexis smaller than 5.00 mm in diameter without injuring the capsule edges. Fits through a 2.00 mm micro incision.

Max opening 2.80 mm
The tip is truncated so as not to hurt the edge of capsulorhexis.



Product design and/or features that do not influence its functionality and main parameters are subject to change

CHOPPERS

RHD for right-handed surgeon - to hold in the left hand
LHD for left-handed surgeon - to hold in the right hand

Stainless Steel hook with an ergonomic
light-weight round serrated
Titanium handle



Nagahara Phaco Chopper

Overall length 120 mm

7-063 RHD (shown) **POPULAR**
7-064 LHD



Nucleus Claw Chopper

Overall length 120 mm

7-072 **POPULAR**



Rosen Phaco Chopper Universal

Overall length 120 mm

7-065 **POPULAR**



Intraocular Manipulator with Ball tip

Straight
0.50 mm diameter ball tip
Overall length 123 mm

7-074

Angled
Overall length 121 mm

7-075



Rosen Phaco Splitter

60 degree angled
Wedge-shaped
Overall length 120 mm

7-066 RHD **POPULAR**
7-067 LHD (shown)



Universal Multifunctional Phaco Chopper

NEW
Anterior sharp edge for horizontal
and vertical nucleus chopping
Blunt posterior surface for iris or
capsular rim retraction
Rounded tip is safe for the
capsule and useful in nucleus
cracking.

Overall length 120 mm

7-0751



Phaco Cleaver

Overall length 120 mm

7-068 RHD (shown) **POPULAR**
7-069 LHD



Small Pupil Snapper Hook & Phaco Chopper

Overall length 121 mm

7-077 **POPULAR**

NEW

Phaco Chopper for Cross-Chop Techniques

Designed for Cross Chop and Quick Chop techniques. Elongated 2.00 mm tip fractures all lens densities. Reduces the use of Ultrasound to lower the risk of endothelial cells loss. Overall length 120 mm

7-0681



Drysdale Nucleus Manipulator & Capsule Polisher

For nucleus dividing and separating
Overall length 121 mm

7-093 Regular tip **POPULAR**
7-0931 Capsule polisher tip

1-093S
SS



Micro Finger Chopper

Overall length 120 mm

7-097



Quick Chopper with Rounded Edge

Overall length 120 mm

7-128 RHD (shown) **POPULAR**
7-1281 LHD



He Phaco Chopper

45° angled, wedge-shaped
Rounded angled polished tip to
separate the nucleus from cortical
material
Overall length 120 mm

7-1061 RHD (shown) **POPULAR**
7-1071 LHD



Seibel Chopper

Chopper with ball-shaped tip for
efficient capsule protection
Overall length 122 mm

7-130 RHD **POPULAR**



Phaonit Quick Chopper

Designed to quickly and easily chop all
grades of nuclei.
Overall length 120 mm

7-125 0.18 mm tip
7-1251 0.35 mm tip

1-125TS
SS



Axe Quick Chopper

Overall length 120 mm

7-135

CHOPPERS

Nagahara Phaco Chopper and Drysdale Nucleus Manipulator

Overall length 128 mm

7-0631 Titanium handle (shown) **POPULAR**

1-0631S

SS



Double Phaco Spatula

Small Pupil Snapper Hook & Micro Finger
Overall length 142 mm

7-079 **POPULAR**



Chang Micro Finger & Quick Chopper

Modified Micro Finger tip with interior edge
to chop and divide soft nucleus
Quick Chopper with sharp point to
penetrate and split hard nucleus
Overall length 125 mm

7-127 RHD Titanium handle **POPULAR**
7-127S RHD Stainless Steel
7-1271 LHD Titanium handle
7-1271S LHD Stainless Steel



Seibel Chopper & Quick Chopper

Ball-shaped tip for efficient capsule
protection
Quick safety chopper with rounded edge
Overall length 132 mm

7-1361 RHD **POPULAR**



Triple Edge Phaco Chopper with Polisher Tip

Overall length 117 mm

7-126

1-126S

SS



Koch Nucleus Spatula

Curved
Duck bill tips with notches
Overall length 122 mm
7-070

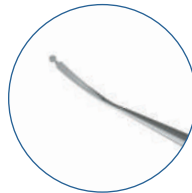

Featured Choppers for FemtoCataract

Slade/Terao Nucleus Splitter

Used to crack the femtochopped nucleus.
 Chopper type design tip
 Curved shaft
 Micro jaws
 With fixation wheel
 Compatible with Squeeze Handle 12-003T
 7-143* 23 Ga



Nagy Femtosecond Chopper

Designed for Femtosecond laser-assisted cataract surgery.
 Cracks the nucleus through the laser-created lines.
 Blunt edge is safe for the posterior capsule.
 Overall length 122 mm
 7-145



Donnenfeld Femto Splitter

For splitting the nucleus
 Angled shaft
 Curved tip
 Overall length 121 mm
 7-146



Curve at the tip provides adequate surface contact for successful splitting of the lens.

*Tip only. Handles are sold separately.
 Product design and/or features that do not influence its functionality and main parameters are subject to change

HYDROCHOPPERS

Lesieur Hydrochopper

This unique design provides a tip that is efficient for chopping as well as manipulating the nucleus without endangering the posterior capsule. Lesieur Hydrochopper is developed specially for Bimanual Microphaco.

20 Ga tip with Nagahara type chopper (for 1.00 mm incisions)
The end opening port provides maximum irrigation.
The dual oval sideports 0.50×0.70 mm provide supplemental irrigation in case when the front opening is overfilled.

Titanium handle/Stainless Steel tip
Overall length 105 mm

7-0634/I 20 Ga



Designed in cooperation with Gilles Lesieur, M.D., France



PHACO
p.154

CAPSULE POLISHERS

Anterior/Posterior Capsule Polisher

135° angled shaft
Overall length 120 mm

7-101 **POPULAR**



Capsule polishing is an important step of phacoemulsification. Polishing the anterior capsule, removing posterior capsular plaque and other residual cortical debris help to achieve and maintain capsular clarity. At the same time the procedure of polishing must be performed with a safe and delicate instrument.

Holz Capsule Polisher

Designed to perform delicate polishing of the capsule.
Angled shaft, "iron"-shaped tip
Texturized tip for polishing of all capsule parts
Sharpened ridge at the top for efficient polishing of the bottom part of the anterior capsule
Overall length 123 mm

7-142



Designed in cooperation with Huck Holz, M.D., U.S.A.



IRRIGATION/ASPIRATION HANDPIECES

Irrigation/Aspiration Handpiece For Coaxial Phaco

Round handle
Standard connectors
Overall length 110 mm
Titanium

7-080/IAH



Tips for Irrigation/Aspiration Handpiece

Stainless Steel

POPULAR



Thornton 20° angled
7-080/20



Binkhorst
7-080/BC



Simcoe
7-080/SIM



45° angled
7-080/45



90° angled
7-080/90



Straight
7-080/ST

Irrigation Handpiece for Bimanual Technique

Curved tube with smooth tip
Titanium handle/Stainless Steel tip
Standard connector
Overall length 104 mm



Irrigates anterior chamber, maintaining its stability and providing for maximal cortex removal.

May be introduced through any side port incision, allowing easy access to all parts of the capsule.

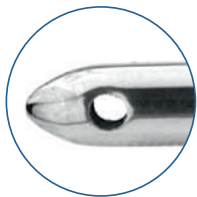

2x0.35 mm side ports
7-081 21 Ga **POPULAR**

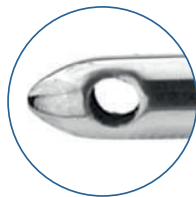

2x0.50 mm side ports
7-0813 21 Ga **POPULAR**

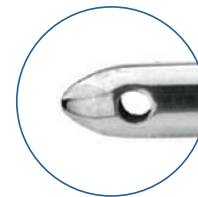

2x0.35 mm side ports
7-081-23 23 Ga **POPULAR**

FEMTOCATARACT
p.157

Stodulka Enhanced Irrigation Handpiece for Bimanual Technique

Handpiece recommended for bimanual microphaco and Femtosecond cataract surgery.
Curved
Two ports on side 0.50x1.00 mm for optimal irrigation
Smooth bullet-shaped tip facilitates instrument insertion.
Titanium handle/Stainless Steel tip
Standard connector
Overall length 105 mm



7-0811 21 Ga

Product design and/or features that do not influence its functionality and main parameters are subject to change

Aspiration Handpiece For Bimanual Technique

Curved tube with smooth or texturized tip
 Titanium handle/Stainless Steel tip
 Standard connector
 Overall length 104 mm



May be introduced through any side port incision, allowing easy access to all parts of the capsule

Removes residual cortex after phacoemulsification

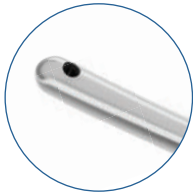

1×0.35 mm top port
 Smooth tip

7-082 21 Ga **POPULAR**

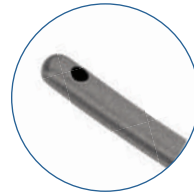

1×0.35 mm top port
 Capsule polisher tip

7-0821 22 Ga **POPULAR**

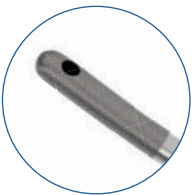

1×0.35 mm top port
 Capsule polisher tip

7-0821-23 23 Ga **POPULAR**

FEMTOCATARACT
 p.157



1×0.30 mm top port
 Smooth tip
 Polished ball tip is safe and atraumatic for the capsular bag.
 No need to enlarge the incision.

7-0826 23 Ga

NEEDLE HOLDERS

Tungsten carbide coated tips for better gripping

Lightweight

KALT NEEDLE HOLDERS

Kalt Needle Holder

For 4.0-6.0 sutures
Straight
Standard jaws, 10.50 mm
Flat serrated locking handle
Overall length 135 mm
Titanium

8-080T **POPULAR**

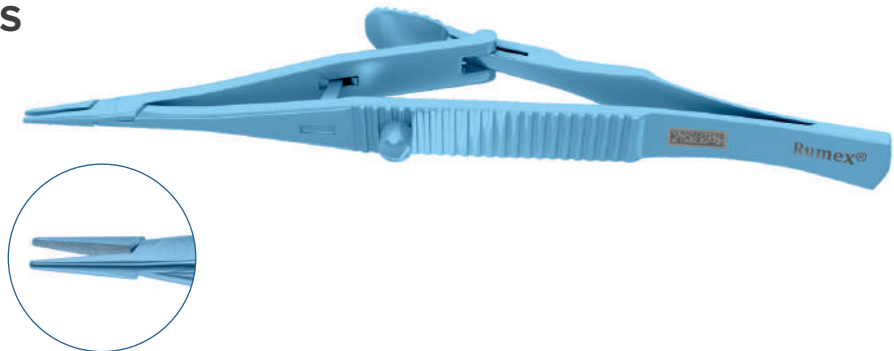

CASTROVIEJO NEEDLE HOLDER

POPULAR

Castroviejo Needle Holder

Titanium
Flat serrated handle

For 4.0-6.0 sutures
Straight delicate jaws, 13.50 mm
Overall length 122 mm

8-0921T with lock

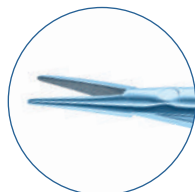

8-0921S
SS

For 4.0-7.0 sutures
Curved standard jaws, 11.00 mm
Overall length 140 mm

8-100T with lock

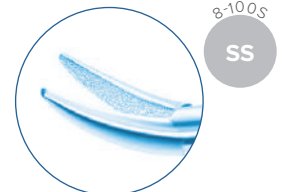

8-100S
SS

For 7.0-9.0 sutures
Curved delicate jaws, 8.00 mm
Overall length 135 mm

8-096T without lock

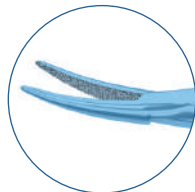

8-096S
SS

ING'S NEEDLE HOLDERS/SCISSORS

Ing's Needle Holder/Scissors

For 4.0-7.0 sutures
Used to cut suture only.
Combination of needle holder and scissors
in one instrument
Straight long size jaws, 15.00 mm
Round handle
Overall length 105 mm
Stainless Steel

8-102S



COAXIAL/INTRAOCULAR NEEDLE HOLDERS

Intraocular Needle Holder

For 9.0-11.0 sutures
Designed for intraocular suturing and
manipulations with the IOL.
Curved shaft
With fixation wheel
Compatible with Squeeze Handle 12-003T

8-1211-23* 23 Ga



*Tip only. Handles are sold separately.

Product design and/or features that do not influence its functionality and main parameters are subject to change

8 - NEEDLE HOLDERS

Coaxial Needle Holder
For IOL Suturing

For 9.0-11.0 sutures
Designed for IOL scleral fixation with suture through a small incision.
Titanium handle with plunger mechanism
Curved shaft
To be used with straight and curved spatulated needles with length up to 18.00 mm (Poly propylene 10-0 or 9-0).
Overall length 128 mm

8-120 18 Ga

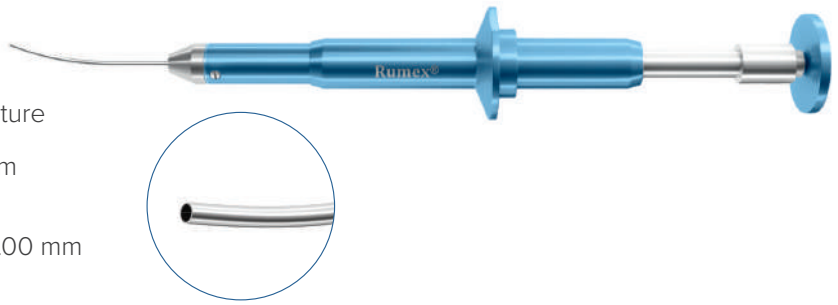

BARRAQUER NEEDLE HOLDER

Tungsten carbide coated tips for better gripping

Lightweight

Barraquer Needle Holder

Titanium
Ergonomic round serrated handle



For 4.0-7.0 sutures
Curved standard jaws, 12.00 mm
Overall length 100 mm

8-010T with lock
8-011T without lock **POPULAR**

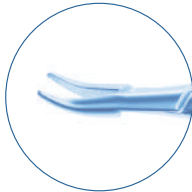

For 8.0-11.0 sutures
Curved extra fine jaws, 8.00 mm
Overall length 115 mm

8-045T without lock **POPULAR**

8-045S
SS

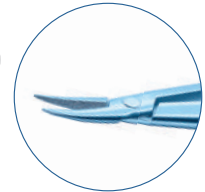

For 4.0-7.0 sutures
Straight standard jaws, 12.00 mm
Overall length 100 mm

8-013T without lock

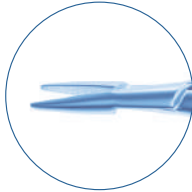

For 4.0-7.0 sutures
Curved extra fine jaws, 8.00 mm
Overall length 125 mm

8-050T with lock
8-051T without lock **POPULAR**

8-051S
SS

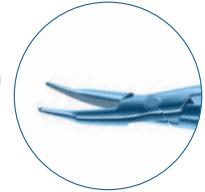

For 4.0-7.0 sutures
Curved fine jaws, 12.00 mm
Overall length 100 mm

8-020T with lock
8-021T without lock

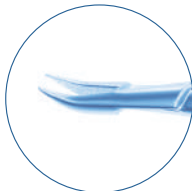

For 4.0-7.0 sutures
Curved standard jaws, 12.00 mm
Overall length 125 mm

8-060T with lock
8-061T without lock

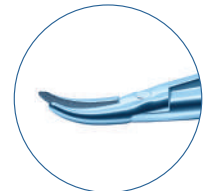

For 8.0-11.0 sutures
Curved extra fine jaws, 8.00 mm
Overall length 100 mm

8-024T with lock
8-025T without lock **POPULAR**

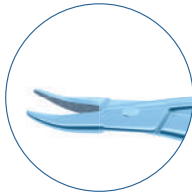

For 4.0-7.0 sutures
Curved fine jaws, 12.00 mm
Overall length 125 mm

8-070T with lock
8-071T without lock **POPULAR**

8-071S
SS

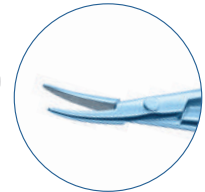

For 4.0-7.0 sutures
Curved standard jaws, 12.00 mm
Overall length 115 mm

8-030T with lock
8-031T without lock **POPULAR**

8-031S
SS

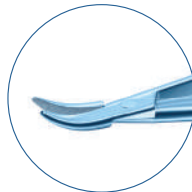

For 4.0-6.0 sutures
Curved strong jaws, 12.00 mm
Overall length 125 mm

8-090T with lock
8-091T without lock **POPULAR**

8-091S
SS

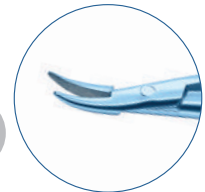

For 4.0-7.0 sutures
Curved fine jaws, 12.00 mm
Overall length 115 mm

8-040T with lock
8-041T without lock **POPULAR**

8-041S
SS

8-040S
SS

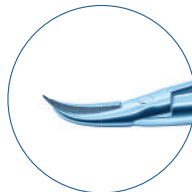

PROBES

Bowman Lacrimal Probe

Overall length 133 mm

- 9-010S size 0000 & 000 **POPULAR**
- 9-011S size 00 & 0
- 9-012S size 1 & 2 **POPULAR**
- 9-013S size 3 & 4 **POPULAR**
- 9-014S size 5 & 6
- 9-015S size 7 & 8



LACRIMAL
p.167

Quickert Lacrimal Intubation Probe

Overall length 140 mm

- 9-021S size 0
- 9-023S size 2



LACRIMAL
p.167

Pigtail Lacrimal Probe

8.00 mm pigtail curved probes with holes
Polished tip
Overall length 125 mm

- 9-031 **POPULAR**



OCULOPLASTIC
p.170

LACRIMAL
p.167

9-031S
SS

Wilder Lacrimal Dilator

Blunt polished tip
Overall length 100 mm
Titanium

- 9-050T size 1 (19.00 mm) **POPULAR**
- 9-051T size 2 (23.00 mm)
- 9-052T size 3 (32.00 mm)

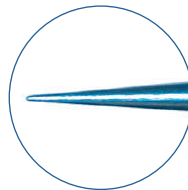

OCULOPLASTIC
p.170

LACRIMAL
p.167

9-050S
SS

9-051S
SS

Castroviejo Double-Ended Lacrimal Dilator

Polished tip
Overall length 100 mm
Titanium

- 9-060T size 1 & 2 **POPULAR**

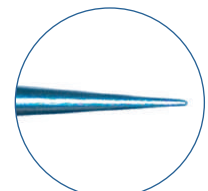
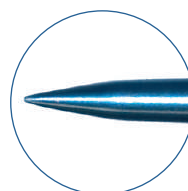

LACRIMAL
p.167

9-060S
SS

RETRACTORS

LACRIMAL SAC RETRACTORS

LACRIMAL p.167 10-013S SS

Stevenson Lacrimal Sac Retractor

Curved
3x3 prongs
Blades separated 25.00 mm
Screw opening
Overall length 83 mm

10-013

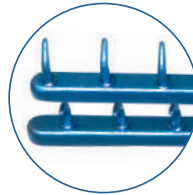
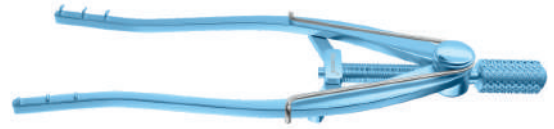

Knapp Lacrimal Sac Retractor

4 blunt prongs
8.00 mm width tip
Overall length 140 mm

10-014 **POPULAR**

OCULOPLASTIC p.170 LACRIMAL p.167 10-014S SS

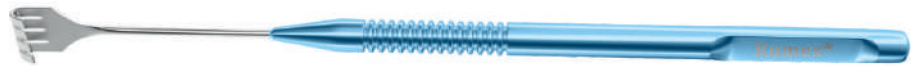

LID & ORBITAL RETRACTORS

Desmarres Lid Retractor

Overall length 130 mm

- 10-020 size 0 - 11.00 mm **POPULAR**
- 10-021 size 1 - 13.00 mm (shown) **POPULAR**
- 10-022 size 2 - 15.00 mm **POPULAR**
- 10-023 size 3 - 17.00 mm **POPULAR**

LID p.168 10-020S SS 10-021S SS 10-022S SS 10-023S SS



Secures the eyelid in the everted position.

May be employed for safe eyelid and lashes isolation during intravitreal injections.

Schepens Orbital Retractor

Overall length 144 mm
Stainless Steel

10-030S



Double-Ended Orbital Globe Retractor-Elevator

Double-ended, 10.00/14.00 mm wide
Thin ribbon retractor with a gentle "S"
curve
Overall length 180 mm
Titanium

10-034T



IRIS (PUPIL) DILATORS

Iris Retractor*

Reusable
Supplied sterile in autoclavable PTFE container
10-5127 **POPULAR**

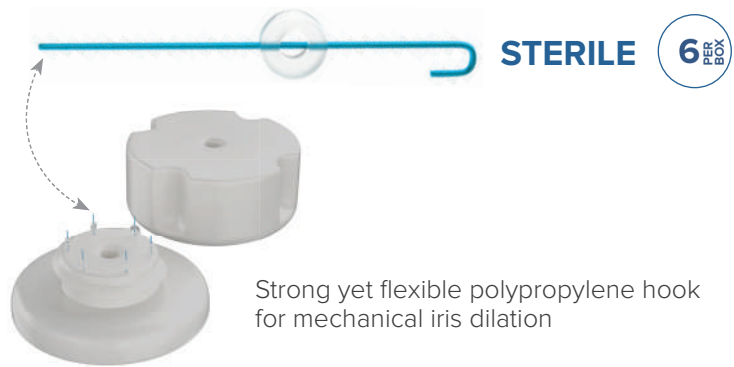

Strong yet flexible polypropylene hook for mechanical iris dilation

Vertical orientation for easy handling

Insertions through 0.50 mm self-sealing incision at the limbus

Iris Retractors*

Disposable
10-5016-1 4 per box **POPULAR**
10-5067-1 5 per box



Beehler Pupil Dilator

17 Gauge
Curved shaft
Four prongs
Overall length 130 mm
Titanium

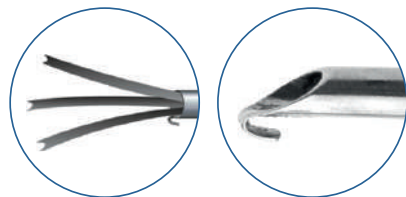

3 fingers for 4 point dilation



10-083

POPULAR



10-091

with plunger

Provides even dilation by allocating tension on all sides of the pupil.

*Not for sale in Europe

Product design and/or features that do not influence its functionality and main parameters are subject to change

SCISSORS

Matte finish/anti-glare coating to reduce a glare of the microscope

Minimal friction

Maraging stainless steel

Unique hardening system promoting 3,000+cuts without resharpening

Sharp cutting edges

CORNEAL SCISSORS

Flat Handle
Stainless Steel

Castroviejo Corneal Scissors

Blunt tips
Curved 7.00 mm blades
11.00 mm from midscrew to tips
Overall length 100 mm



11-010S Left (shown)
11-0101S Right

Castroviejo Universal Corneal Scissors

Blunt tips
7.50 mm blades
Overall length 102 mm

11-011S

11.00 mm blades
Overall length 106 mm

11-012S



11-011S **POPULAR**
11-012S

Castroviejo Universal Corneal Scissors

Blunt tips
Curved 13.00 mm blades
16.00 mm from midscrew to tip
Overall length 110 mm



11-015S **POPULAR**

Osher Universal Corneal Scissors

Blunt tips
Gently curved 13.00 mm blades
21.00 mm from midscrew to tip
Provide a precise 6.50 mm beveled incision opening with a single snip.
Overall length 120 mm



11-013S

Corneal Universal Scissors

Blunt tips
Curved
Round handle
Overall length 110/112 mm
Stainless Steel



11-034S 7.50 mm blades
11-035S 11.00 mm blades (shown) **POPULAR**



Katzin Corneal Transplant Scissors

Blunt tips
Strongly curved 8.00 mm blades
9.50 mm from midscrew to tips
Overall length 100 mm



11-020S Left (shown)
11-0201S Right



POPULAR

Castroviejo Corneal Section Scissors

11.50 mm blades
14.00 mm from midscrew to tips
Lower blade is 0.50 mm longer than upper.
Overall length 106 mm



11-024S Right (shown)
11-0241S Left **POPULAR**



DALK Corneal transplant scissors

Blades with blunt ledge are used to perform the superficial keratectasia. Remove the 4 parts of separated stromal layers after the «Big Bubble» procedure.
Overall length 106 mm



11-038S Right (shown)
11-0381S Left

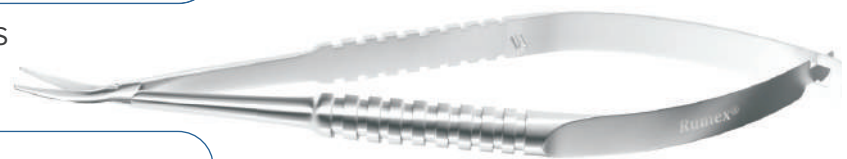

Product design and/or features that do not influence its functionality and main parameters are subject to change

DLEK
p.163

**DLEK
Corneal Transplant Scissors**

For the removal of the posterior cornea
Long blades
Overall length 102 mm
Stainless Steel

- 11-036S Medium curve
- 11-0361S Strong curve



11-036S

11-0361S

DALK
p.162

Holland Spatulated DALK Scissors

Vannas-style scissors with “micro blades” facilitate the dissection of stromal tissue. Rounded and blunt tips
Horizontally-oriented, spatulated design of the inner blade keeps the scissors in the proper plane minimizing inadvertent perforation.
Shortened outer blade allows to trim the tissue in a precise fashion.
Overall length 100 mm
Stainless Steel

- 11-134 Right (shown)
- 11-135 Left

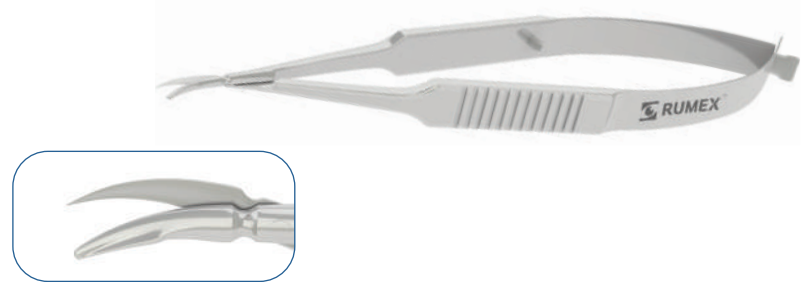

IRIS SCISSORS

**Zaldivar
Iridectomy Scissors**

Straight shaft
With fixation wheel
Compatible with Squeeze Handle 12-003T

- 11-03721* 23 Ga



**McPherson-Vannas
Iris Scissors**

Curved
8.00 mm blades
Sharp pointed tips
Round handle
Overall length 85 mm
Stainless Steel

- 11-062S **POPULAR**

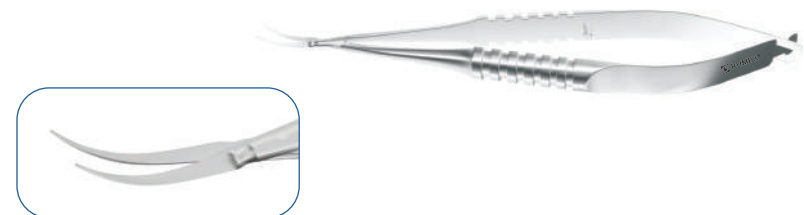

Iris Scissors

28.00 mm pointed tips from midscrew to tip
Ring handle
Overall length 115 mm
Stainless Steel

- 11-080S Straight (shown) **POPULAR**
- 11-081S Curved



*Tip only. Handles are sold separately.
Product design and/or features that do not influence its functionality and main parameters are subject to change

11 - SCISSORS

**Barraquer
Iris Scissors**

7.00 mm blades
Blunt tips
Squeeze action handle
Overall length 55 mm
Stainless Steel

11-1223 **POPULAR**

**STITCH SCISSORS****Westcott
Stitch Scissors**

Gently curved
16.00 mm blades
21.00 mm from pivot to tip
Sharp pointed tips
Overall length 120 mm
Stainless Steel

11-044S Standard jaws (shown) **POPULAR**
11-125S Westcott type slim jaws

**Westcott
Stitch Scissors**

Gently curved
13.00 mm blades
15.00 mm from pivot to tip
Sharp pointed tips
Overall length 115 mm
Stainless Steel

11-046S Flat handle **POPULAR**
11-047S Round handle

**STRABISMUS SCISSORS****Knapp
Strabismus Scissors**

Ring handle
Overall length 115 mm
Stainless Steel

11-100S Straight (shown) **POPULAR**
11-101S Curved



TENOTOMY SCISSORS

Westcott Tenotomy Scissors

Stainless Steel
Curved
Blunt tips



Westcott Tenotomy Scissors

13.00 mm blades
15.00 mm from pivot to tip
Overall length 115 mm

11-040S **POPULAR**



Westcott Tenotomy Scissors

15.00 mm blades
19.00 mm from pivot to tip
Overall length 116 mm

11-048S Right **POPULAR**



Westcott Tenotomy Scissors

16.00 mm blades
21.00 mm from pivot to tip
Overall length 120 mm

11-042S **POPULAR**



Shepard-Westcott Tenotomy scissors

16.00 mm blades
Serrated upper blade («supercut»)
21.00 mm from pivot to tip
Overall length 123 mm

11-0481S Right



Stevens Tenotomy scissors

Overall length 115 mm
Stainless Steel

- 11-130S straight, sharp tips
- 11-131S curved, sharp tips
- 11-132S curved, blunt tips
- 11-133S straight, blunt tips (shown)

POPULAR



CAPSULOTOMY SCISSORS

Side Port Capsulotomy Scissors

Curved shaft
With fixation wheel
Compatible with Squeeze Handle 12-003T

11-03741* Left 20 Ga (shown)
11-03751* Right 20 Ga

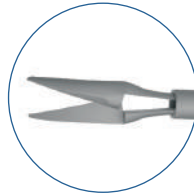

Capsulotomy Scissors

Sharp pointed tips
Stainless Steel



Vannas Capsulotomy Scissors

Straight
6.00 mm blades
9.00 mm from pivot to tip
Overall length 84 mm

11-050S **POPULAR**



Gills-Vannas Capsulotomy Scissors

Straight
10.00 mm blades
13.00 mm from pivot to tip
Overall length 88 mm

11-056S **POPULAR**



Vannas Capsulotomy Scissors

Curved
6.00 mm blades
9.00 mm from pivot to tip
Overall length 84 mm

11-052S **POPULAR**



Gills-Vannas Capsulotomy Scissors

Curved
10.00 mm blades
13.00 mm from pivot to tip
Overall length 88 mm

11-058S **POPULAR**



Vannas Capsulotomy Scissors

Angled
6.00 mm blades
9.00 mm from pivot to tip
Overall length 81 mm

11-054S **POPULAR**



Gills-Vannas Capsulotomy Scissors

Angled
10.00 mm blades
13.00 mm from pivot to tip
Overall length 84 mm

11-0581S **POPULAR**



Clayman-Vannas Swan Neck Capsulotomy Scissors

Straight
5.00 mm blades
7.00 mm from pivot to tip
Sharp pointed tips
Smooth handle
Overall length 82 mm
Stainless Steel

11-0501S



*Tip only. Handles are sold separately.

Product design and/or features that do not influence its functionality and main parameters are subject to change



ENUCLEATION SCISSORS

Enucleation Scissors

Curved
Blunt tips
Ring handle
Stainless Steel

Medium size
Blades from midscrew to tip - 38.00 mm
Overall length 128 mm

11-090S (shown)

Large size
Blades from midscrew to tip - 45.00 mm
Overall length 130 mm

11-091S



IOL CUTTERS/SCISSORS

Osher IOL Scissors

To cut silicone or acrylic IOL
8.50 mm blades
Overall length 91 mm
Stainless Steel

4-2175S **POPULAR**



Rowen Rescue Kit Scissors

Intraocular scissors for foldable lens removal
To remove silicone or acrylic IOL in case of complications
Curved shaft
Compatible with Squeeze Handle 12-003T

4-2151* 18 Ga **POPULAR**



Micro Foldable Lens Cutter

Intraocular scissors for foldable lens removal
To remove silicone or acrylic IOL in case of complications
Blades with notches
Curved shaft
Compatible with Squeeze Handle 12-003T

4-2173* 19 Ga

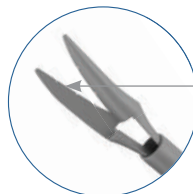

Notches

*Tip only. Handles are sold separately.
Product design and/or features that do not influence its functionality and main parameters are subject to change

SPATULAS

IRIS/NUCLEUS SPATULAS

13-011S
SS13-014S
SS

Straight Spatula

Overall length 122 mm

13-010 0.25 mm width, 10.00 mm length (shown)

13-011 0.40 mm width, 14.00 mm length **POPULAR**

13-014 1.00 mm width, 13.00 mm length

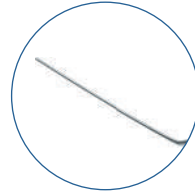

Curved Spatula

Overall length 122 mm

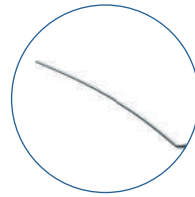
13-020 0.25 mm width, 12.00 mm length **POPULAR**

Double Spatula

Overall length 134 mm

13-031 0.50 & 1.00 mm width **POPULAR**

Overall length 134 mm

13-032 0.30 & 0.50 mm width

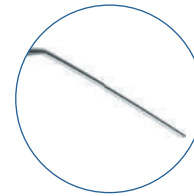
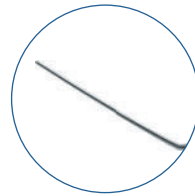
13-031S
SS

CYCLODIALYSIS SPATULAS

GLAUCOMA
p.164

Castroviejo Double-Ended Cyclodialysis Spatula

Overall length 136 mm

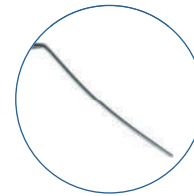
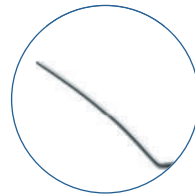
13-050 0.50 mm width, 10.00 & 15.00 mm **POPULAR**

Castroviejo Cyclodialysis Spatula

Overall length 124 mm

13-051 1.00 mm width, 10.00 mm length

13-052 0.75 mm width, 10.00 mm length



FEMTOSECOND CATARACT SPATULAS



Spatula for Femtosecond Laser Procedure

Used for opening cataract incision created by femtosecond laser system. Specially designed for Alcon LenSx® Laser. Also compatible with incisions made by VICTUS™ Femtosecond Laser platform (Bausch & Lomb).
1.40 mm length flat tip
Overall length 120 mm



20-204

Donnenfeld Femto Spatula



Special flattened design of the tip helps to open femtosecond created cataract incisions.
Overall length 122 mm

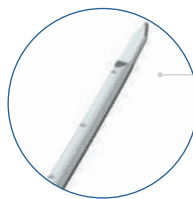

10 serrations for intraocular measurement (from 1.00 mm to 10.00 mm with 1.00 mm increment)

20-2041

Double-Ended Femto Spatula

NEW

Safe and quick Femtosecond incisions opening
Blunt flattened spear easily detects the entering point.
Blunt keratome-shaped tip facilitates incision opening.
Overall length 132 mm



20-061

Uy Laser Lens Fragmentation Combo Manipulator



Double-ended instrument for Femtosecond cataract procedure combining a chopper and a spatulated tip for nuclear, epinuclear and cortical fragments manipulating
Overall length 131 mm



13-181

CORNEAL SPATULAS

Paton Spatula and Spoon

Double-ended instrument for manipulations with the cornea (LASIK/PRK/Corneal Transplantation)
Overall length 150 mm



13-110

Product design and/or features that do not influence its functionality and main parameters are subject to change

DSEK, DSAEK, DMEK SPATULASDLEK
p.163DSEK, DSAEK, DMEK
p.162**Corneal Dissector**

For intrastromal dissection
 Straight
 60° angled shaft
 12.00 mm from tip to angle
 Overall length 125 mm
 13-137

**Corneal Dissector**

For intrastromal dissection
 Curved (curvature radius 22.00 mm)
 45° angled shaft
 12.00 mm from tip to angle
 Overall length 127 mm
 13-138

DSEK, DSAEK, DMEK
p.162**Irrigating Endothelial Stripper**

For Descemet's stripping
 Overall length 104 mm
 13-139/I

DSEK, DSAEK, DMEK
p.162**Spatula-Guide**

For corneal endothelium implantation
 Overall length 122 mm
 Titanium
 13-150T



DSEK, DSAEK, DMEK SPATULAS

Cindy Sweeper DSEK Spatula

Angled shaft
12.00 mm from bend to tip
0.70 mm diameter
Overall length 111 mm
Stainless Steel

13-151S



Smoothens out the area between the donor graft and recipient's stromal bed.

Carlson DSEK Smoother

Angled/vaulted shaft
7.50 mm from tip to angle
2.50 mm blunt ball
Overall length 119 mm
Stainless Steel

13-152S



Removes extra fluid between the donor and recipient's tissues.

Terry DSEK Scraper

Angled shaft
11.00 mm from tip to angle
Hole-shaped scraper facing upward
Overall length 112 mm
Stainless Steel

13-153S

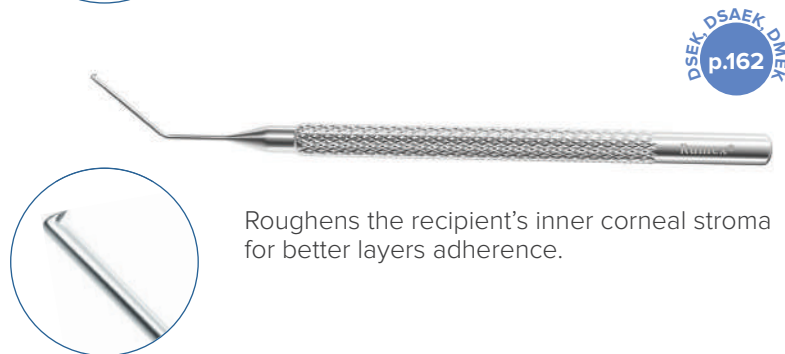

Roughens the recipient's inner corneal stroma for better layers adherence.

Melles Style 1 DSAEK PLK Scraper

45° angled shaft
11.00 mm from tip to angle
45° angled tip
Overall length 125 mm
Titanium

13-154T



Melles Style 2 DSAEK PLK Scraper

45° angled shaft
11.00 mm from tip to angle
90° angled tip
Overall length 125 mm
Titanium

13-155T

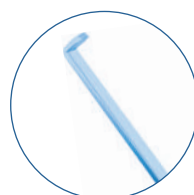

John DSAEK Descemet's Stripper

Curved shaft
14.00 mm from bend to tip
"T" shape 1.50 mm wide x 0.60 mm high tip
Efficient in cases of strong adherence of the Descemet's membrane to recipient's corneal stroma.
Overall length 121 mm

13-1491



John Dexatome DMEK/ DSAEK Spatula

Removes the Descemet's membrane as a single disc.
Strongly vaulted shaft
Overall length 119 mm

13-182



DSEK, DSAEK, DMEK
p.162

John DSAEK Stromal Scrubber

Roughens the inner corneal stroma at the periphery of Descemetorhexis.
Minimizes the risk of disk detachment after DSAEK.
Strongly vaulted shaft
Round handle
Overall length 120 mm

13-183



DSEK, DSAEK, DMEK
p.162

John DSAEK Glider

Used for donor disk gliding.
Smoothens the corneal surface and clears fluid in the donor-recipient interface.
Overall length 114 mm

13-184



DSEK, DSAEK, DMEK
p.162

Tan Marginal DMEK Dissector

Double-tipped end is designed for cutting the peripheral ends of donor Descemet's membrane (DM) without risk of radial tears occurrence.
Curved single-tipped end is used for convenient separation of the DM from the stroma.
Overall length 132 mm

13-185

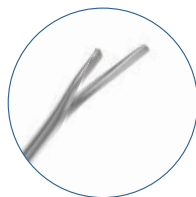

DSEK, DSAEK, DMEK
p.162

DLEK SPATULAS

DLEK
p.163

Manipulator for DLEK procedure

Designed to tuck the edges of the donor lamella.

0.15 mm diameter Z-hook with blunt tip

Overall length 120 mm

13-160

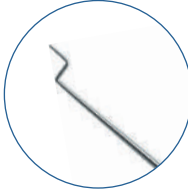

DALK SPATULAS

DALK
p.162

Trisector for DALK Procedure

Facilitates separation of rest of stromal attachments from Descemet's membrane at the periphery.

Blunt bottom surface is safe for Descemet's membrane.

The anterior surface has an edge that facilitates the enlarging of stromal opening with a blade.

Flat 1.40×0.70 mm tip

Overall length 124 mm

13-170

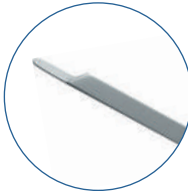

Spatula for DALK Procedure

The center groove can be used as a guide for the blade facilitating the enlarging of stromal opening.

Blunt bottom surface is safe for Descemet's membrane.

Flat 1.00×9.00 mm tip

Overall length 122 mm

13-171



Dissector for DALK Procedure

Creates a track in deep stroma for the further cannula inserting.

Obtains delicate preparation for "Big Bubble" procedure.

12.00 mm length blunt beveled tip

Overall length 122 mm

13-172



FOREIGN BODY SPUDS

Davis Foreign Body Spud

Overall length 123 mm

16-153

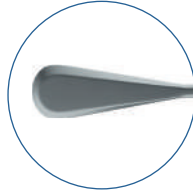

PRK/LASIK SPATULAS

Hockey Knife for Epithelium Removal

To remove epithelium for PRK procedure and during LASIK retreatment

Overall length 130 mm

20-001 **POPULAR**



LASIK
p.159

20-001S
SS

Lindstrom LASIK/PRK Spatula and Epithelium Removal Board

Semi-sharp end of the instrument is designed to remove epithelium. Fine spatula on the other end is used for flap manipulation during LASIK surgery.

Overall length 148 mm

20-002



LASIK
p.159

LASIK Spatula and Flap Retreatment Instrument

Double-ended
Overall length 133 mm

20-013

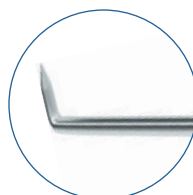

LASIK
p.159

LASEK SPATULAS

LASEK Epithelial Micro Hoe

Can be used to detach and lift the edge of the epithelium flap.
Overall length 120 mm

20-131



LASEK
p.159

LASEK Knife

The sharp anterior part of the knife is used to detach epithelium from the incision. The blunt part of the knife is for repositioning of the epithelium after the ablation.

Overall length 128 mm

20-0011 **POPULAR**



LASEK
p.159

SMILE SPATULAS

Stodulka ReLEx Smile Double Lenticule Spatula

Blunt spoon and flat spatula
Overall length 140 mm

20-207 **POPULAR**

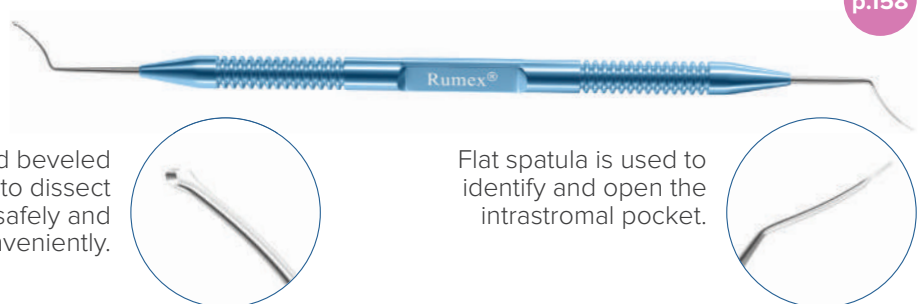

SMILE
p.158

Wide disc-shaped beveled tip allows to dissect the lenticule safely and conveniently.

Flat spatula is used to identify and open the intrastromal pocket.

ReLEx Smile Double Lenticule Spatula

Blunt spoon and shortened atraumatic spatula
Overall length 139 mm

20-2071



SMILE
p.158

Wide disc-shaped beveled tip allows to dissect the lenticule safely and conveniently.

Flat shortened spatula

SMILE Lenticule Removing Spatula

Double-function tool
Delicate reversed hook for easy identification and capture of lenticule edge
Modified spatula for smooth and safe removal

Overall length 120 mm

20-2073



NEW SMILE
p.158

FEMTOLASIK SPATULAS

FemtoLASIK Flap Spatula Double-Ended

A delicate pick and a curved spatula to open and manipulate the flap
Overall length 128 mm

20-201 **POPULAR**



FemtoLASIK Flap Spatula

Delicate spatula with a jag on the tip to detach the flap edge and to open the flap
Overall length 121 mm

20-202



Zaldivar FemtoLASIK Spatula

Extra delicate spatula with bullet shaped tip to open and manipulate the flap
Overall length 123 mm

20-203 **POPULAR**



ICL™ SPATULAS

Pallikaris ICL™ Manipulator

Designed to place the lens corners under the iris.

Sandblasted tip
Overall length 123 mm

13-141



ICL
p.160

ICL™ — registered trademark of STAAR®



Zaldivar ICL™ Manipulator

Double-ended instrument with slightly forked tips to place the lens corners under the iris

Overall length 128 mm

13-142



ICL
p.160

ICL™ — registered trademark of STAAR®



ICRS SPATULAS

Elevator for ICRS Implantation

To create a small pocket in intended direction of the tunnel with a mild rotatory movement

Straight shaft
Tip dimensions: 0.10 mm height, 0.20 mm width, 0.70 mm length
Overall length 123 mm

10-035



ICRS
p.163



Suarez Spreader

To enlarge the small corneal pockets in both directions in a proper depth

Straight shaft
Tip dimensions: 0.10 mm height, 0.60 mm width, 1.25 mm length
Overall length 122 mm

13-146



ICRS
p.163

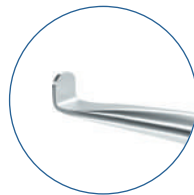

Bicalto Guide

To lift the cornea for inserting the Tunnel Maker beneath the guide

Blunt tip
Tip dimensions: 0.30 mm height, 0.10 mm width, 5.00 mm length
Overall length 121 mm

13-147



ICRS
p.163

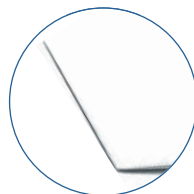

SPECULUMS

SPECULUMS WITH ASPIRATION

Thumb-screw control to adjust lid tension

Ports on each blade allow continuous aspiration providing better vision during the operation.

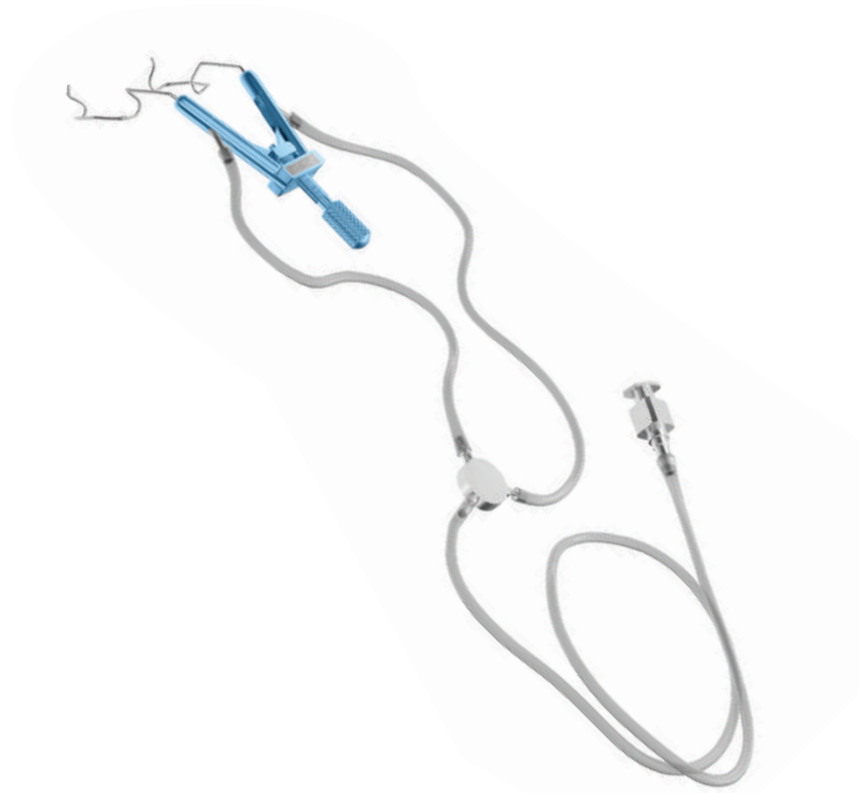

Kershner Style

14-060S
SS

Reversible
Nasal/temporal approach
Solid blades, 14.00 mm
Overall length 70 mm

14-060A Adult

Lieberman Style

Temporal
“V” style open
blades, 14.00 mm
Overall length 78 mm

14-080A Adult **POPULAR**

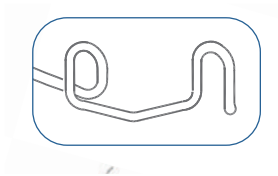

Lieberman Style for LASIK

Temporal
Rounded open
blades, 14.00 mm
Overall length 78 mm

14-080LA Adult

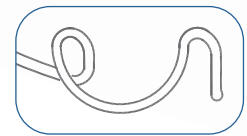

LASEK
p.159

FEMTOLASIK
p.159

Child Lieberman Style

Temporal
«V» style open
blades, 10.00 mm
Overall length 64 mm

14-082A Child

Lieberman Style for LASIK

Nasal
Rounded open blades, 14.00 mm
Overall length 75 mm

14-081LA Adult

LANCASTER SPECULUMS

Lancaster Eye Speculum

Adjustable mechanism with locking nut
Spring-control with locking mechanism and stabilizing disk
Solid-shaped slightly curved blades fit orbital margin, keep eyelashes from the surgical area, and provide optimal view.

Temporal
Solid blades, 16.00 mm
Overall length 70 mm
Titanium
14-045T



CASTROVIEJO SPECULUMS

Castroviejo Speculum

Temporal
Fenestrated blades, 14.00 mm
Blades spread 30.00 mm
Flat branches
Overall length 85 mm
Titanium

14-061T Adult **POPULAR**

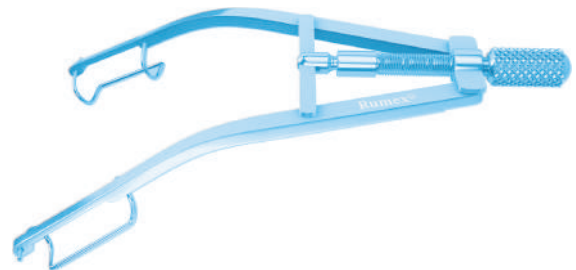

REVERSIBLE SPECULUMS KERSHNER STYLE

Can be used both for nasal and temporal approach.

Kershner Reversible Speculum

Fenestrated blades, 14.00 mm
Flat branches
Overall length 70 mm
Titanium

14-062T Adult



14-0601S
SS

14-0605S
SS

Kershner Reversible Speculum

Adult
Solid blades, 14.00 mm
Overall length 70 mm
Titanium

14-060T Round branches

14-0601T Flat branches

POPULAR



Product design and/or features that do not influence its functionality and main parameters are subject to change

TEMPORAL SPECULUMS LIEBERMAN STYLE

Thumb-screw control to adjust lid tension

Temporal Speculum

Lieberman Style

Titanium



14-040S
SS

«V» style open blades, 14.00 mm
Round branches
Overall length 76 mm

14-040T Adult **POPULAR**

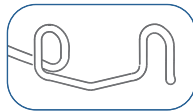

Kratz style open blades, 14.00 mm
Flat branches
Overall length 76 mm

14-0401TK Adult **POPULAR**



«V» style open blades, 10.00 mm
Round branches
Overall length 60 mm

14-042T/S Child **POPULAR**

14-042S
SS

«V» style open blades, 14.00 mm
Flat branches
Overall length 76 mm

14-0401T Adult **POPULAR**

14-0401S
SS

For LASIK
Rounded open blades, 14.00 mm
Round branches
Overall length 76 mm

14-040TL Adult **POPULAR**

FEMTO LASIK p.159
LASEK p.159



Specially designed to accommodate microkeratome suction ring.

Kratz style open blades, 14.00 mm
Round branches
Overall length 71 mm

14-040TK Adult **POPULAR**

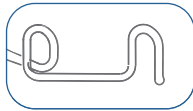

For LASIK
Rounded open blades, 14.00 mm
Flat branches
Overall length 76 mm

14-0401TL Adult

TEMPORAL FEMTO SPECULUMS

Slade-Murdoch Speculum

Adjustable Speculum with Lath Mechanism

Parallel retraction design. Quick installation and removal due to self-locking mechanism. Blades specially curved to facilitate laser docking without increasing external pressure.

Temporal
Open 14.00 mm blades
Overall length 54 mm

14-052T



SMILE p.158
FEMTOCATARACT p.157

SAUER SPECULUMS

Temporal
Solid blades
Blade spread 20.00 mm
Overall length 35/25/20 mm

14-030 Child (8.00 mm blades)
14-031 Newborn (5.00 mm blades)
14-032 Premature (4.00 mm blades)



Product design and/or features that do not influence its functionality and main parameters are subject to change

NASAL SPECULUMS LIEBERMAN STYLE

Thumb-screw control to adjust lid tension

Nasal Speculum Lieberman Style

Titanium

«V» style open blades
14.00 mm
Round branches
Overall length 70 mm

14-041T Adult **POPULAR**

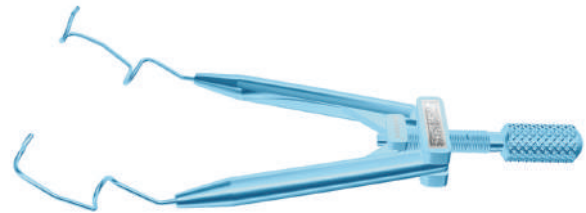
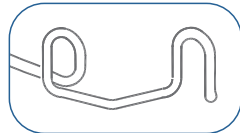

«V» style open blades,
10.00 mm
Round branches
Overall length 60 mm

14-043T Child

«V» style open blades,
14.00 mm
Flat branches
Overall length 70 mm

14-0411T Adult

«V» style open blades,
10.00 mm
Flat branches
Overall length 60 mm

14-0431T Child

Kratz style open blades,
14.00 mm
Round branches
Overall length 70 mm

14-041TK Adult

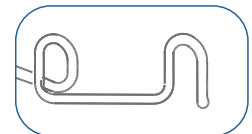

For LASIK
Rounded open blades,
14.00 mm
Flat branches
Overall length 70 mm

14-0411TL Adult

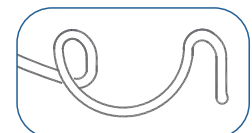

Specially designed to accommodate microkeratome suction ring.

BARRAQUER WIRE SPECULUMS

Angled for temporal approach

Stainless Steel



Closed rounded wire blades

14.00 mm blades
Overall length 45 mm

14-022S Adult **POPULAR**

11.00 mm blades
Overall length 38 mm

14-023S Child **POPULAR**

10.00 mm blades
Overall length 38 mm

14-024S Infant **POPULAR**

4.00 mm blades
Overall length 25 mm

14-0244S Newborn **POPULAR**



Solid blades

14.00 mm blades
Overall length 40 mm

14-0221S Adult **POPULAR**

11.00 mm blades
Overall length 35 mm

14-0231 Child

5.00 mm blades
Overall length 28 mm

14-0241S Newborn

4.00mm blades
Overall length 28 mm
14-0222S Premature

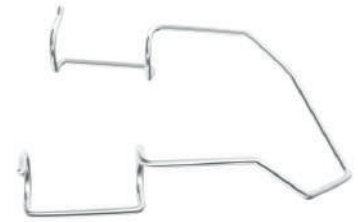

Open wire blades

14.00 mm blades
Overall length 45 mm

14-025S Adult **POPULAR**

11.00 mm blades
Overall length 40 mm

14-026S Child



Closed wire blades

14.00 mm blades,
Overall length 40 mm

14-028S Adult **POPULAR**

11.00 mm blades,
Overall length 36 mm

14-0281S Child



Open rounded wire blades

14.00 mm blades,
Overall length 40 mm

14-0282S Adult



Open wire blades

14.00 mm blades,
Overall length 45 mm

14-0286S Adult

10.00 mm blades,
Overall length 36 mm

14-0287S Child

CANNULAS

ANESTHESIA CANNULAS

Used to deliver anesthetic agents inside the muscle cone or the posterior Sub-Tenon's space.



Sub-Tenon's Anesthesia Cannula

Curved
0.30 mm side port

15-009 19 Ga × 25 mm



Atkinson Retrobulbar Needle

15-001-23 23 Ga × 38 mm

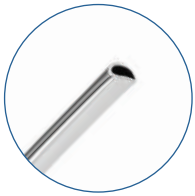

Sub-Tenon's Anesthesia Cannula

Curved
Flattened tip
Front opening

15-013-19 19 Ga × 25 mm



Sub-Tenon's Anesthesia Cannula

Curved
3 ports of 0.40 mm
15-011C-19 19 Ga × 25 mm

ANTERIOR CHAMBER CANNULAS

Used for maintaining and forming the anterior chamber by injecting or removing air, fluids, viscoelastics and intraocular medications.

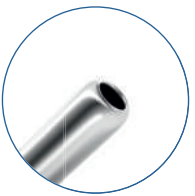

Rycroft Anterior Chamber Cannula

Angled 45°
4 mm angled tip
15-051-23 23 Ga × 22 mm
15-051-25 25 Ga × 22 mm
15-051-27 27 Ga × 22 mm **POPULAR**
15-051-30 30 Ga × 22 mm

6 mm angled tip
15-052-27 27 Ga × 22 mm

8 mm angled tip
15-053-27 27 Ga × 22 mm

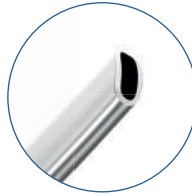

Bishop-Harmon Anterior Chamber Cannula

8 mm angled tip
Angled 40°
Spatulated
15-055-19 19 Ga × 25 mm **POPULAR**

Product design and/or features that do not influence its functionality and main parameters are subject to change

15 - CANNULAS



Bracken Anterior Chamber Cannula

Curved 90°
Flattened beveled tip
15-057 19 Ga × 23 mm



McIntyre Anterior Chamber Cannula

Angled 45°
Smooth blunt tip
Front opening
15-061-26 26 Ga × 20 mm



Lewicky Anterior Chamber Maintainer

Self-retaining threaded tip for stable fixation within the corneal stroma
27.5 cm silicone tubing
15-065 20 Ga × 3.5 mm tip **POPULAR**



Jaymce Anterior Chamber Maintainer

Bulbous beveled tip allows easy insertion and stable fixation within the corneal stroma
27.5 cm silicone tubing
15-1067 20 Ga × 4 mm tip

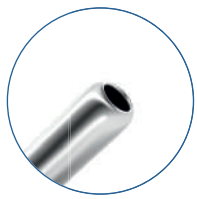

Irrigating Cannulas

Straight
Blunt polished tip
15-049-23 23 Ga × 25 mm
15-049-30 30 Ga × 25 mm



Girard Anterior Chamber Maintainer

Atkinson tip
27.5 cm silicone tubing
15-067 23 Ga × 5 mm tip **POPULAR**

IRRIGATING/ASPIRATING CANNULAS

Used for removing cortical debris or viscoelastic solution while maintaining the anterior chamber during cataract surgery.

Simcoe I/A Cannulas

Regular
0.30/0.40 mm irrigation port, 0.40 mm side opening for aspiration
Irrigation through luer-lock hub, aspiration through the silicone tubing hub

15-129-0.3 23/23 Ga **POPULAR**
15-129-0.4 23/23 Ga

Reverse
0.30/0.40 mm aspiration port, 0.40 mm side opening for irrigation
Aspiration through luer-lock hub, irrigation through the silicone tubing hub

15-133-0.3 23/23 Ga
15-133-0.4 23/23 Ga

Product design and/or features that do not influence its functionality and main parameters are subject to change





Gills I/A Cannula

Side by side front opening

15-119 23/23Ga



J-Shaped I/A Cannula

Regular
"J" shape facilitates removal of cortex at 12 o'clock position
0.30 mm top port

15-1149R 23/23 Ga, Right

LENS REMOVAL/NUCLEUS REMOVAL CANNULAS

Specifically designed to aid in phacoemulsification during the lens extraction phase. The loop is placed between the lens and the posterior chamber, ensuring an atraumatic lens removal.



Knolle-Pearse Irrigating Vectis

3 irrigating ports at 12, 10 and 2 o'clock
Loop 5.00 mm wide, 9.00 mm long

15-183 23 Ga x 35 mm



Sheets Irrigating Vectis

3 irrigating ports
Serrations on top
Loop 6.50 mm wide, 19.00 mm long

15-203 21 Ga x 38 mm

HYDRODISSECTION/HYDRODELINEATION CANNULAS

Designed for easy placement under the anterior capsule to deliver fluids to facilitate the separation of the cortex from the capsule.

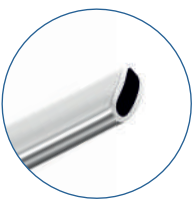

McIntyre Nucleus Hydrodissector

Flattened on the horizontal plane tip provides the broad stream of fluid
Angled 45°, 11 mm angled tip

15-071-23 23 Ga x 22 mm
15-071-25 25 Ga x 22 mm
15-071-27 27 Ga x 22 mm

POPULAR



Chang Nucleus Hydrodissector

Beveled tip used to rotate the nucleus
Flat tip ensures easy insertion under the capsular rim and broad stream of fluid
Angled 90°

15-0681 27 Ga x 16 mm **POPULAR**

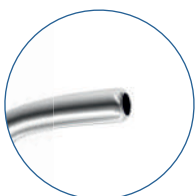

Pearce J-Shaped Micro Hydrodissector

Hook 1.75 mm wide, 2.25 mm long
"J" shape facilitates hydrodissection at the 12 o'clock position

15-073-27 27 Ga x 22 mm

Product design and/or features that do not influence its functionality and main parameters are subject to change

CORTEX REMOVAL CANNULAS

Used to remove cortical material during phacoemulsification.



McIntyre-Binkhorst Cannula

Left
Blunt tip

15-079L 26 Ga × 22 mm



Simcoe Cortex Extractor Cannula

0.35 mm side port

15-091-13/23 23 Ga × 13 mm



CYSTOTOME CANNULAS

Used to perform capsulorhexis. Tip is designed for opening of anterior capsule.



Kelman Sharp Irrigating Cystotome

Curved sharp cutting edge

15-025 25 Ga × 32 mm



CAPSULE POLISHERS

Specially designed for scrubbing all parts of the capsular bag. Tungsten carbide coating of the tip ensures the delicate and efficient capsule polishing.



Microincisional Capsule Polisher

Disc-shaped sandblasted tip
Curved tube for better visualization
For a sub-2.00 mm incision

15-170 23 Ga × 25 mm



Kratz Capsule Polisher

0.30 mm side port
Angled, blasted 3 mm from end

15-169-23 23 Ga × 22 mm

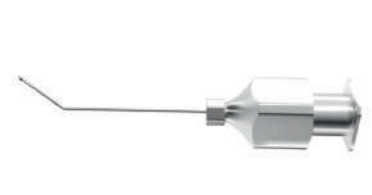

Jensen Capsule Polisher

Gently curved
Olive-shaped sandblasted tip

15-159-25 25 Ga × 28 mm
15-159-27 27 Ga × 28 mm

POPULAR



GLAUCOMA CANNULAS



Viscocanalostomy Cannula

For viscoelastic injection during Glaucoma surgery
Angled micro-gauge cannula with 5 mm beveled tip

15-1051-30 30 Ga × 20 mm

DALK CANNULAS

DALK
p.162

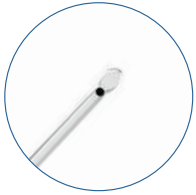

Cannula for DALK Procedure

Bottom port 0.20 mm
Designed for air injection in order to achieve an ideal "Big Bubble"

15-450-27 27 Ga × 38 mm **POPULAR**

REFRACTIVE CANNULAS



Vidaurri LASIK Irrigation Cannula

Universal cannula simultaneously irrigates both sides of the flap, washes the stromal bed and enables the flap positioning
Double-armed, 8 irrigating ports

15-371-25 25 Ga × 22 mm



FEMTOLASIK
p.159

LASIK
p.159

Buratto LASIK Irrigation Cannula

3 irrigating ports of 0.25 mm

15-379-25 25 Ga × 32 mm

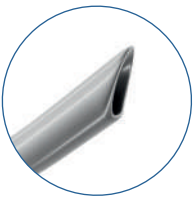

LASIK
p.159

Slade LASIK Cannula

Flattened spatulated tip

15-376 26 Ga × 25 mm



LASIK
p.159

Banaji LASIK Irrigation Cannula

Curved
4 ports of 0.25 mm

15-373-25 25 Ga × 22 mm **POPULAR**



Gimbel LASIK Fountain Cannula

Right
Single port of 0.25 mm

15-378R 25 Ga × 25 mm

Product design and/or features that do not influence its functionality and main parameters are subject to change

LACRIMAL CANNULAS

For surgical treatment, repair and irrigation of the nasolacrimal system.



Lacrimal Cannulas

23 Ga cannula with 20 Ga reinforced shaft
Malleable tip

- 15-027 23 Ga × 32 mm, Straight
- 15-029 23 Ga × 32 mm, Curved
(shown)



Bailey Lacrimal Cannula

Straight
23 Ga cannula with 20 Ga reinforced shaft

- 15-031 23 Ga × 15 mm **POPULAR**



Shahinian Lacrimal Cannula

Smooth bullet shape tip

- 15-032 25 Ga × 35 mm



Fasanella Lacrimal Cannula

Gently curved

- 15-033 23 Ga × 42 mm **POPULAR**



Anel Lacrimal Cannulas

Special long mount blunt tip
Straight

- 15-035-23S 23 Ga × 20 mm
- 15-035-25S 25 Ga × 20 mm



Anel Lacrimal Cannulas

Special long mount blunt tip
Curved

- 15-035-23C 23 Ga × 20 mm
- 15-035-25C 25 Ga × 20 mm

ACCESSORIES

Designed to be attached to a cannula for irrigation and/or aspiration during ophthalmic surgeries.



Silicone Bulb with Adapter
15-301/303 **POPULAR**



Titanium Microsurgical Handle

- Male-Male (shown) 15-307T
- Male-Female 15-308T

Product design and/or features that do not influence its functionality and main parameters are subject to change

MISCELLANEOUS

ALGERBRUSH INSTRUMENTS*

COMPLETE SET OF A POWER HANDLE, CHUCK, AND BURR



Pterygium Remover

Diamond burr provides excellent smoothing of corneal surface after surgical removal of the tissue.

POPULAR
16-051-2.5 With a 2.50 mm
Diamond Round Fine Grit Burr

POPULAR
16-050-3.5 With a 3.50 mm
Diamond Round Medium
Grit Burr

16-050-5.0 With a 5.00 mm



Rust Rings Remover

Used to remove foreign bodies and rust rings from patient's eye. Tungsten carbide coating ensures efficient corneal surface smoothing.

POPULAR
16-140 With a 1.00 mm Burr

POPULAR
16-141 With a 0.50 mm Burr



ALGERBRUSH REPLACEMENT BURRS*

Pterygium Remover Replacement Burrs with Chuck

1 per box, reusable, non-sterile

POPULAR
16-051-2.5B Diamond Round Fine Grit Burr,
2.50 mm

POPULAR
16-051-3.5B Diamond Round Medium
Grit Burr, 3.50 mm

POPULAR
16-052-5.0B Diamond Disk-Shaped Medium
Grit Burr, 5.00 mm



Rust Rings Remover Replacement Burrs

5 per box, reusable, non-sterile

POPULAR
16-142B Tungsten Burr, 1.00 mm

POPULAR
16-143B Tungsten Burr, 0.50 mm



*Not available in Canada

Product design and/or features that do not influence its functionality and main parameters are subject to change

DISPOSABLE ELECTRIC EYE CAUTERIES

Electric Eye Cautery

Battery operated
Low temperature

16-041 adjustable fine tip
16-042 elongated fine tip

STERILE

2

10
BOX

FIXATION RINGS

Fine-Thornton Phaco Fixation Ring

3/4 open ring with swivel
Titanium

13.00 mm diameter ring with teeth
Overall length 96 mm

16-036T

14.00 mm diameter ring with teeth
Overall length 98 mm

16-034IT **POPULAR**16-036S
SS

FLIERINGA RINGS

Flieringa Rings

Sutured to the sclera to support the globe
during difficult eye operations.

Stainless Steel

16-030-14 (14.00 mm)

16-030-17 (17.00 mm)

16-030-20 (20.00 mm)

16-030-15 (15.00 mm)

16-030-18 (18.00 mm)

16-030-21 (21.00 mm)

16-030-16 (16.00 mm)

16-030-19 (19.00 mm)

16-030-22 (22.00 mm)

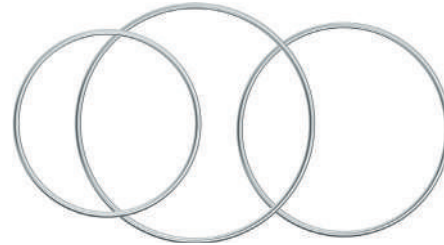

INJECTORS

Injector for Capsular Ring with Irrigation

Designed for one-hand implantation of the
capsular tension rings with diameters of 10,
11 and 12 mm.

Allows to implant the capsular tension ring
clockwise and counter-clockwise.

Back cover of the instrument can be
easily opened to flush and clean the inner
mechanism of the injector.

Overall length 162 mm

16-253

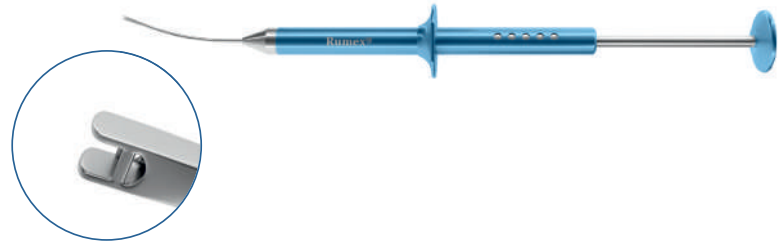

IOL Injector

Plunger mechanism with reverse inner spring
for easy and efficient one-handed implantation technique
Specially designed handle with a ring enables firm
grip and precise control.

Can be supplied with **4-2141T IOL Loading Forceps**.
Overall length 212 mm

16-2806* For A, B, C cartridges

16-2808* For D cartridge **POPULAR**ECCE
p.156PHACO
p.154

*Not available in US, Japan, Germany, Switzerland

Product design and/or features that do not influence its functionality and main parameters are subject to change

IOL Injector

Plunger mechanism with reverse inner spring for easy and efficient one-handed implantation technique
 Specially designed handle enables firm grip and precise control.
 Can be supplied with **4-2141T IOL Loading Forceps**.
 Overall length 187,5 mm
 16-2807* For D cartridge



IOL Injector NaviJect™

Plunger mechanism with reverse inner spring for easy and efficient one-handed implantation technique
 Specially designed handle with a ring for precise control.
 To be used with **IOL cartridges CAT-22, CAT-24**.
 Overall length 178,5 mm
 16-2853*



LENS LOOPS

Wilder
 Lens Loop
 4.00 mm width
 Overall length 134 mm
 16-072 **POPULAR**



16-072S
 SS

LID PLATES

Lid Plate
 20.00 mm and 24.00 mm wide
 Nonreflecting surface
 Overall length 110 mm

16-50S Stainless Steel (shown) **POPULAR**
 16-50T Titanium



OCULOPLASTIC p.170
 LID p.168

PUNCHES & RONGEURS

Belz
 Lacrimal Sac Rongeur
 Polished finish
 Overall length 185 mm
 Stainless Steel
 16-138



LACRIMAL p.167

Kerrison
 Rongeur
 3.00 mm wide
 9.00 mm opening
 Polished finish
 Stainless Steel
 Overall length 140 mm
 16-136 size 0



LACRIMAL p.167

*Not available in US, Japan, Germany, Switzerland
 Product design and/or features that do not influence its functionality and main parameters are subject to change

RUMEX Corneoscleral Punch

Set of Stainless Steel tips:
0.50 mm, 0.75 mm, 1.00 mm, 1.50 mm
Titanium handle
Overall length 122 mm
16-010



Used to perform a sclerectomy at the corneoscleral junction.

- Standard spring mechanism for precise control
- 360° rotatable tip for convenient positioning
- No need to hold the scleral flap

Micro Trabeculectomy Punch

0.60 mm diameter head
Bullet-shaped tip
0.30 mm × 0.60 mm deep bite
Compatible with Squeeze Handle 12-003T
Tip only
16-0111* 20 Ga

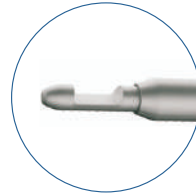

GLAUCOMA
p.164

16-0111S
SS

Kelly Descemet's Membrane Punch

Stainless Steel tip
Serrated squeeze action Titanium handle
Overall length 131 mm
16-011 **POPULAR**

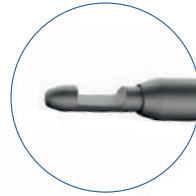

SCLERAL DEPRESSORS

Flynn Scleral Depressor

Loop style tip for depressing pediatric sclera
Overall length 100 mm
16-115 **POPULAR**



Schocket Double-Ended Scleral Depressor

With pocket clip
Overall length 143 mm
16-111 Titanium Handle/Stainless Steel tips **POPULAR**



16-111S
SS

SPOONS & CURETTES

Bunge Evisceration Spoon

Small size
Overall length 137 mm
16-061

Large size
Overall length 141 mm
16-062



ENUCLEATION
p.171

Meyerhoefer Chalazion Curette

Overall length 135 mm
16-063 size 0 (1.50 mm)
16-064 size 1 (1.75 mm)
16-065 size 2 (2.00 mm)
16-066 size 3 (2.50 mm)
16-067 size 4 (3.50 mm)

POPULAR

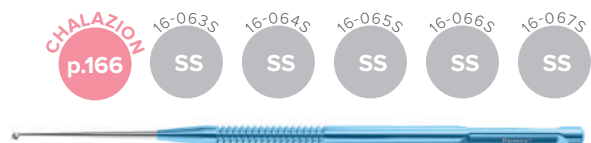
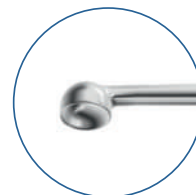

CHALAZION
p.166

16-063S
SS

16-064S
SS

16-065S
SS

16-066S
SS

16-067S
SS

*Tip only. Handles are sold separately.

Product design and/or features that do not influence its functionality and main parameters are subject to change

**Wells
Enucleation Spoon**

Overall length 145 mm
16-060



ENUCLEATION
p.171

SURGICAL MALLETS & CHISELS

Surgical Chisel

3.00 mm
Overall length 136 mm
Stainless Steel
16-137



Surgical Mallet

Polished finish
Overall length 177 mm
Stainless Steel
16-135



LACRIMAL
p.167

NASAL SPECULUMS

Nasal Speculum

Adult size
Polished finish
Stainless Steel
Overall length 150 mm
16-127



LACRIMAL
p.167

TRABECULOTOMES

**Harms
Trabeculotome**

9.00 mm long pointed tips with 3.00 mm spread
Overall length 51 mm
Stainless Steel

16-012S left (shown)
16-013S right



GLAUCOMA
p.164

TREPHINES

Corneal Trephine Blades

Polished finish
Stainless Steel

16-0300	6.00 mm	16-0307	8.00 mm	POPULAR
16-0301	6.50 mm	16-0308	8.25 mm	
16-0303	7.00 mm	16-0309	8.50 mm	POPULAR
16-0305	7.50 mm	16-0310	9.00 mm	POPULAR
16-0306	7.75 mm	16-0311	9.50 mm	



CORNEAL
p.161

TUNNEL MAKERS

Tunnel Maker

ID 4.40 mm/ED 5.60 mm
Stainless Steel

16-173S Left
16-174S Right



ICRS
p.163

PERIOSTEAL ELEVATORS

Tenzel Periosteal Elevator

Shaft size to tip - 30.00 mm
Paddle width - 4.00 mm
Paddle thickness -1.40 mm
Overall length - 130 mm
Stainless Steel



The smooth end is used for blunt dissection of the periosteum over the inferior and lateral orbital rim. The sharp edge is used to reflect periosteum from the incision in a downward direction over the cheekbone.

16-139

Product design and/or features that do not influence its functionality and main parameters are subject to change

STERILIZATION TRAYS

Size Chart

Item	Inserts	Dimensions		Size	Configuration	Accommodates, number of instruments
		mm	in			
Plastic Tray						
18-300	2 silicone plug-in inserts	190×101×38	7.5×4×1.5"	Medium	Single level	1
18-301-1	2 silicone plug-in inserts	152×63.5×19	6×2.5×0.75"	Small	Single level	2
18-305-1	2 silicone plug-in inserts	254×152.4×38	10×6×1.5"	Large	Single level	3
18-303-1	2 silicone plug-in inserts	190×101×19	7.5×4×0.75"	Medium	Single level	4
18-300-1	silicone finger tip mat	190×101×38	7.5×4×1.5"	Medium	Single level	4-6
18-301	silicone finger tip mat	152×63.5×19	6×2.5×0.75"	Small	Single level	2-3
18-302	silicone finger tip mat	165×101×19	6.5×4×0.75"	Small	Single level	4-5
18-303	silicone finger tip mat	190×101×19	7.5×4×0.75"	Medium	Single level	4-6
18-304	silicone finger tip mat	254×152×19	10×6×0.75"	Large	Single level	10-15
18-305	silicone finger tip mat	254×152×38	10×6×1.5"	Extra Large	Double level	20-30
18-307	silicone finger tip mat	68.5×38×25.5	3×1.5×1"	Very Small	Single level	1-2
18-308	silicone finger tip mat	190.5×63.5×19	7.5×2.5×0.75"	Medium	Single level	4-5
Stainless Steel Trays						
18-318	silicone finger tip mat	240×240×60	9.5×9.5×2.5"	Extra Large	Double level	20-30
Aluminum Trays						
18-319	silicone finger tip mat	155×65×20	6.0×2.5×0.80"	Small	Single level	2-3
18-320	silicone finger tip mat	155×65×40	6.0×2.5×1.5"	Small	Single level	2-3
18-321	silicone finger tip mat	200×65×20	7.75×2.5×0.80"	Medium	Single level	4-5
18-322	silicone finger tip mat	200×110×20	7.75×4.25×0.80"	Medium	Single level	4-6
18-323	silicone finger tip mat	200×110×40	7.75×4.25×1.5"	Medium	Single level	4-6
18-324	silicone finger tip mat	260×160×20	10.25×6.25×0.80"	Large	Single level	10-15
18-325	silicone finger tip mat	260×160×40	10.25×6.25×1.5"	Large	Single level	10-15
18-326	silicone finger tip mat	260×160×40	10.25×6.25×1.5"	Extra Large	Double level	20-30
18-327	silicone finger tip mat	260×160×80	10.25×6.25×3.25"	Extra Large	Double level	20-30
18-328	silicone finger tip mat	260×160×80	10.25×6.25×3.25"	Large	Single level	10-15
18-331	silicone finger tip mat	215×165×20	8.50×6.50×0.80"	Large	Single level	6-8
18-332	silicone finger tip mat	310×235×20	12.25×9.25×0.80"	Extra Large	Single level	20-30
18-333	silicone finger tip mat	375×220×45	14.75×8.75×1.75"	Extra Large	Double Level + Open Section	30-45
18-334	silicone finger tip mat	390×265×20	15.5×10.5×0.80"	Extra Large	Single level	25-35
18-335	silicone finger tip mat	390×265×40	15.5×10.5×1.5"	Extra Large	Single level	25-35
18-336	silicone finger tip mat	390×265×40	15.5×10.5×1.5"	Extra Large	Double level	50-70

PLASTIC TRAYS

RUMEX plastic trays are molded from General Electric's ULTEM® resin, using mold flow analysis to guarantee product strength, structural integrity, and extended life cycle. Trays come either with silicone finger tip mat or plug-in inserts.



18-300

Silicone inserts
for 1 instrument
190x101x38 mm
7.5x4x1.5 in

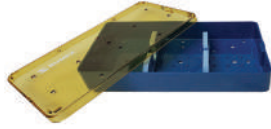

18-303-1

Silicone inserts
for 4 instruments
190x101x19 mm
7.5x4x0.75 in

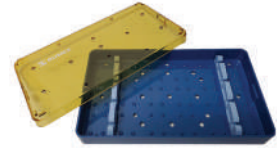

18-305-1

Silicone inserts
for 3 instruments
254x152.4x38 mm
10x6x1.5 in

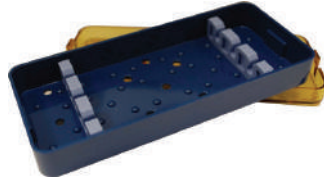

18-301-1

Silicone inserts
for 2 instruments
152x63.5x19 mm
6x2.5x0.75 in

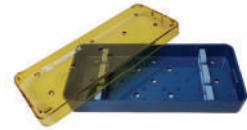

18-301 **POPULAR**

152x63.5x19 mm
6x2.5x1.5 in

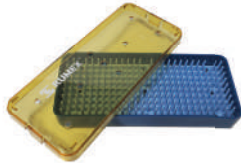

18-300-1

190x101x38 mm
7.5x4x1.5 in

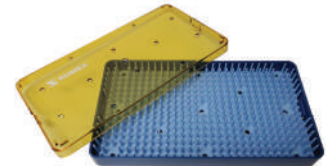

18-308 **POPULAR**

190.5x63.5x19 mm
7.5x2.5x0.75 in

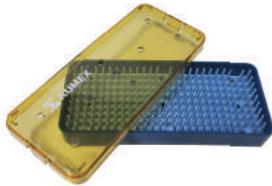

18-302 **POPULAR**

165x101x19 mm
6.5x4x0.75 in

18-303 **POPULAR**

190x101x19 mm
7.5x4x0.75 in

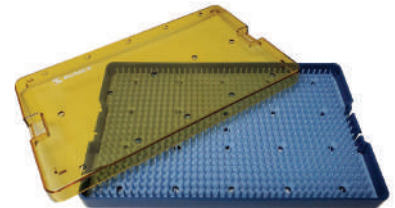

18-304 **POPULAR**

254x152x19 mm
10x6x0.75 in

18-303

190x101x19 mm
7.5x4x0.75 in

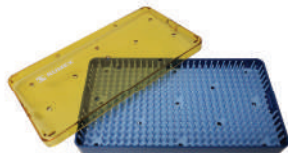

18-305 **POPULAR**

Double Level
254x152x38 mm
10x6x1.5 in

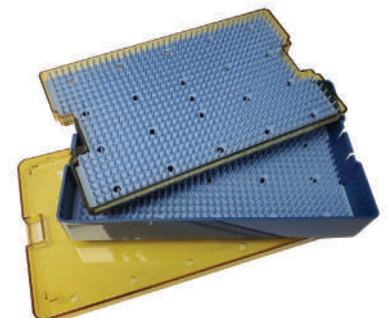

18-307

68.6x38x25.4 mm
3x1.5x1 in



ALUMINUM TRAYS

RUMEX aluminum trays are manufactured from an anodized aluminum alloy to prevent corrosion and ensure long-term use. This aluminum alloy has high thermal conductivity for faster drying. The trays are lightweight for easy transportation and handling. Trays come with silicone finger tip mat.

NEW

**AUTOCLAVE
STEAM
DRY HEAT
CHEMICAL**



18-319

155x65x20 mm
6x2.5x0.8 in

18-320

155x65x40 mm
6x2.5x1.5 in

18-321

200x65x20 mm
2.5x7.75x0.8 in

18-322

200x110x20 mm
7.75x4.25x0.8 in

18-323

200x110x40 mm
7.75x4.25x1.5 in

18-324

260x160x20 mm
10.25x6.25x0.8 in

18-325

260x160x40 mm
10.25x6.25x1.5 in

18-328

260x160x80 mm
10.25x6.25x3.25 in

18-326

Double Level
260x160x40 mm
10.25x6.25x1.5 in

18-327

Double Level
260x160x80 mm
10.25x6.25x3.25 in

STAINLESS STEEL TRAYS

18-318

With silicone mat, double level
240x240x60 mm
9.5x9.5x2.5 in

18-331

215x165x20 mm
8.5x6.5x0.8 in

18-332

310x235x20 mm
12.25x9.25x0.8 in

18-333

Double Level +
Open Section
375x220x45 mm
14.75x8.75x1.75 in

18-334

390x265x20 mm
15.5x10.5x0.8 in

18-335

390x265x40 mm
15.5x10.5x1.5 in

18-336

Double Level
390x265x40 mm
15.5x10.5x1.5 in

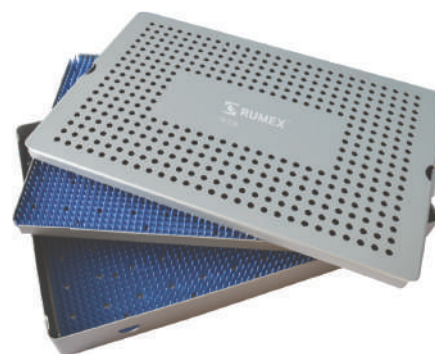
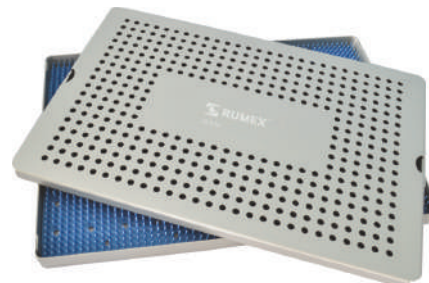
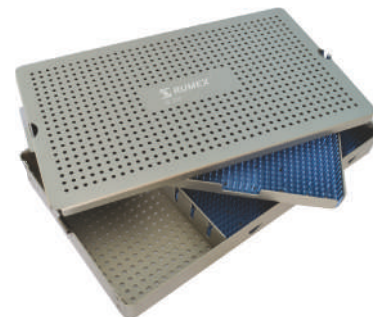
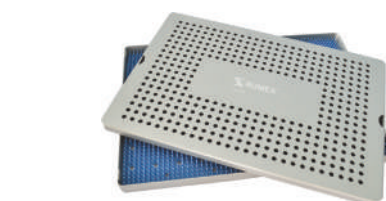
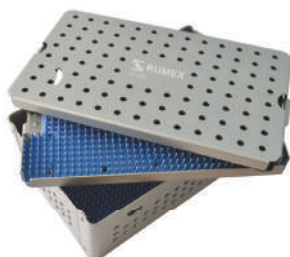
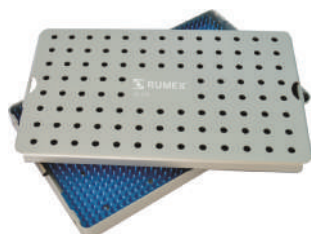
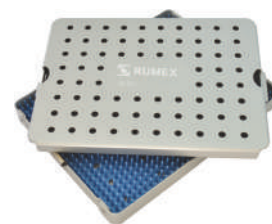

LASEK/LASIK INSTRUMENTS

SPATULAS

LASIK Spatula and Flap Retreatment Instrument

Double-ended
Overall length 133 mm
20-013

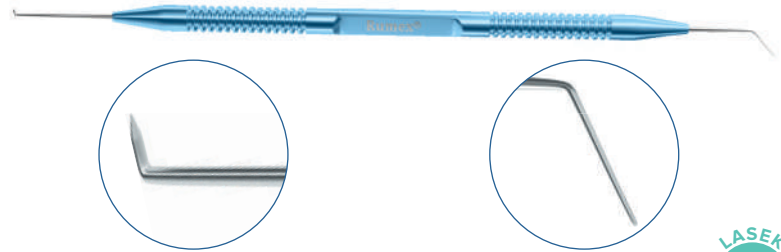

LASEK Epithelial Micro Hoe

Can be used to detach edge of the epithelium flap.
Overall length 120 mm
20-131

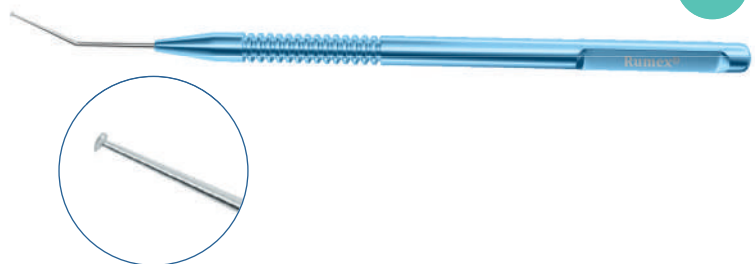

LASEK Knife

The sharp anterior part of the knife is used to detach epithelium from the incision.
The blunt part of the knife is for repositioning of the epithelium after the ablation.
Overall length 128 mm

20-0011 **POPULAR**

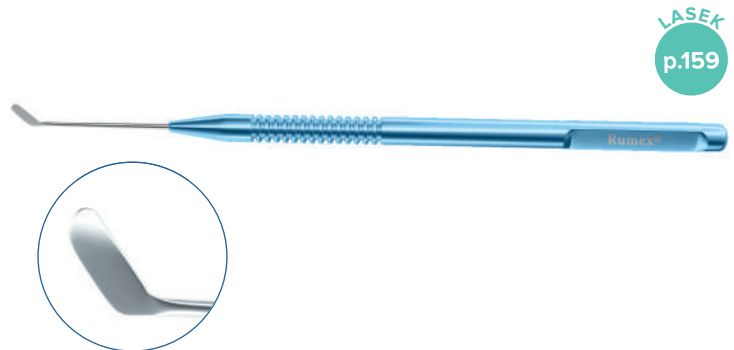

SPATULAS

FEMTOLASIK
p.159

FemtoLASIK Flap Spatula

Double-ended
A delicate pick and a curved spatula to open and manipulate the flap
Overall length 128 mm

20-201 **POPULAR**



FEMTOLASIK
p.159

FemtoLASIK Flap Spatula

Delicate spatula with a jag on the tip to detach the flap edge and to open the flap
Overall length 130 mm

20-202



FEMTOLASIK
p.159

Zaldivar FemtoLASIK Spatula

Extra delicate spatula with bullet-shaped tip to open and manipulate the flap
Overall length 123 mm

20-203 **POPULAR**



EPITHELIUM REMOVAL KNIVES

LASIK p.159 20-001s SS

Hockey Knife

To remove epithelium during PRK procedure and LASIK retreatment
Overall length 128 mm

20-001 **POPULAR**

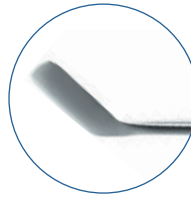

LASIK p.159

Lindstrom LASIK/PRK Spatula and Epithelium Removal Board

Semi-sharp end of the instrument is designed to remove epithelium. Fine spatula on the other end is used for flap manipulation during LASIK surgery.

Overall length 148 mm

20-002



TREPHINES AND FUNNELS

LASEK Trephine

For epithelial flap creation
Depth of the incision 70 µm
Overall length 128 mm

20-1011 8.00 mm
20-1021 9.00 mm



LASEK Funnel

For application of alcohol solution
For 8.00 mm and 9.00 mm optical zones
Overall length 129 mm
Titanium

20-1031T 8.50 mm
20-1041T 9.50 mm

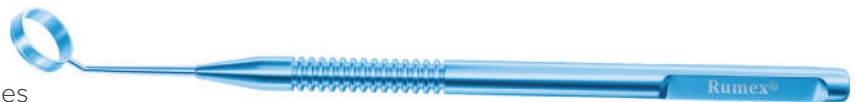

LASEK p.159

LASEK Trephine & Funnel

For epithelial flap creation
Depth of the incision 70 µm
For application of alcohol solution
For 8.00 mm and 9.00 mm optical zones
Overall length 142 mm

20-121 8.00 & 8.50 mm
20-122 9.00 & 9.50 mm



DON'T FORGET TO BUY

MARKING PENS

STERILE

2

10 PER BOX

Disposable Marking Pen

Double-ended

20-050 **POPULAR**



POPULAR

SKU preferred by the majority of customers

NEW

Recently introduced into the product range of RUMEX International Co.



Disposable instruments



Available in a single-use edition



Available in Stainless Steel



Featured instrument in the set on page 100

**DON'T FORGET
TO BUY**

Frequently bought together



Quantity in the box

VITREORETINAL INSTRUMENTS AND CONSUMABLES

A VARIETY OF OPTIONS FOR VITREORETINAL SURGERY	132
FEATURED PRODUCTS	133
VITREORETINAL INSTRUMENT TIPS	134
HANDLES FOR VITREORETINAL INSTRUMENTS	135
SCISSORS	136
INTERNAL LIMITING MEMBRANE (ILM) FORCEPS	137
EPIRETINAL FORCEPS	138
PICK FORCEPS	139
FOREIGN BODY REMOVAL FORCEPS	139
MEMBRANE INSTRUMENTS	140
23 GAUGE INSTRUMENTS	141
25 GAUGE INSTRUMENTS	142
27 GAUGE INSTRUMENTS	142
ONE-PIECE VITREORETINAL INSTRUMENTS WITH FLUSHING SYSTEM	143
REUSABLE TWO STEP TROCAR SYSTEMS	144
DISPOSABLE ONE-PIECE STAINLESS STEEL INSTRUMENTS	145
DISPOSABLE INSTRUMENTS WITH PLASTIC HANDLE	146
DISPOSABLE DIAMOND DUSTED RETRACTABLE ILM ELEVATORS	146
DISPOSABLE ONE STEP TROCAR SYSTEMS	147
DISPOSABLE BACKFLUSH INSTRUMENTS	148
BACKFLUSH HANDLES AND RESERVOIRS	148
VITREORETINAL CANNULAS	149
SILICONE OIL 1000\5000	150
SILICONE OIL INFUSION SYSTEMS	151

A VARIETY OF OPTIONS FOR VITREORETINAL SURGERY

REUSABLE

EASY TO CLEAN

Option 1. Two-Piece Instruments

Universal Handle + Interchangeable Tips*

Money-Wise Solution



*completely detachable for most effective cleaning

Option 2. One-Piece Instruments

with Innovative RUMEX Flushing System**

Flushing port

Flushing cannula



Complete tool – no need to adjust the tip to the handle

Delicate cleaning – flushing liquid streams towards the tips with zero stress for the jaws

Increased lifespan – the inner mechanism is not involved into the cleaning process and stays intact

DISPOSABLE

READY FOR USE

Option 1. All Stainless Steel Instruments

Precise performance and instant tactile control

STERILE

2

6 PER BOX

SHELF LIFE 3 YEARS



Option 2. Ergonomic 360-Degree Handle*

Enhanced utility due to rotatable squeeze handle

SHELF LIFE 5 YEARS

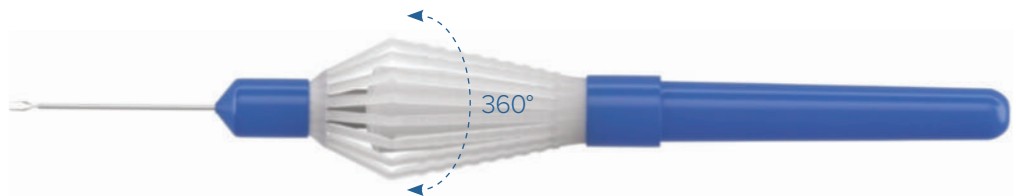

*Not available in Europe, US

Product design and/or features that do not influence its functionality and main parameters are subject to change

FEATURED PRODUCTS

Universal End-Grasping Forceps with Asymmetrical Branches

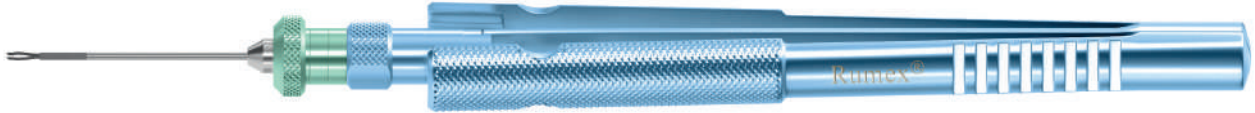

Universal End-Grasping Forceps allow the performing of ILM peeling and safe removal of epiretinal membranes. Asymmetrical design of branches provides for ideal maneuverability and excellent visualization of the grasped tissue.



- | | | |
|-----------|-------|----------------|
| 12-420-23 | 23 Ga | POPULAR |
| 12-420-25 | 25 Ga | POPULAR |
| 12-420-27 | 27 Ga | |
| Tip only | | |

End-Grasping Forceps

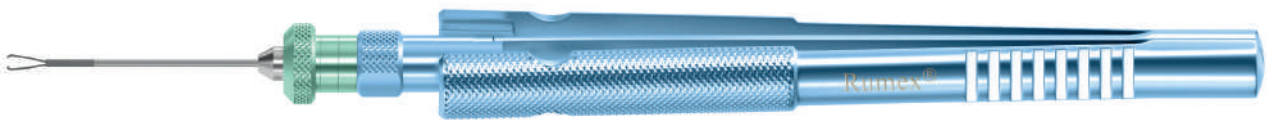

The special design of the tips promotes delicate, precise and safe ILM peeling. The strengthened jaws ensure enhanced gripping power. Expanded space between branches contributes to greater visualization of the grasped membrane in the macular area.



- | | | |
|----------|-------|----------------|
| 12-4013 | 23 Ga | POPULAR |
| Tip only | | |

Gripping Forceps with a 'Crocodile' Platform

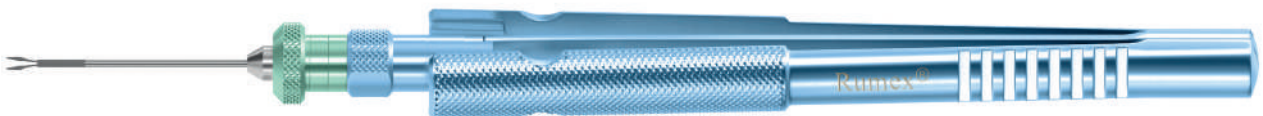

Designed for the removal of epiretinal membranes. Blunt, atraumatic serration intensifies grasping capacity and prevents tissue shredding.



- | | | |
|-----------|-------|----------------|
| 12-304 | 20 Ga | |
| 12-304-23 | 23 Ga | POPULAR |
| 12-304-25 | 25 Ga | |
| Tip only | | |

VITREORETINAL INSTRUMENT TIPS: GAUGE CONVERSION CHART, COLOR CODE SYSTEM

We offer various models of vitreoretinal tips that can be adjusted to Universal Handles (12-001T or 12-003T)*.

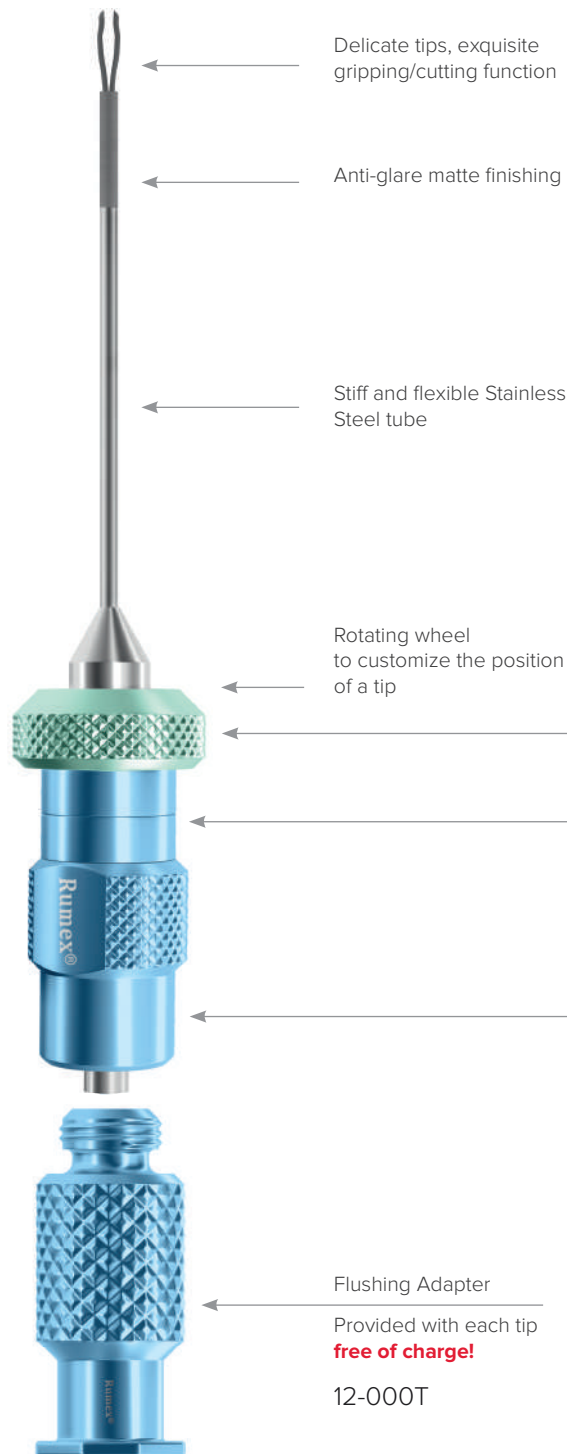

Gauge Conversion Chart		
Gauge	(inch)	(mm)
19 Ga	0.043	1.10
20 Ga	0.036	0.90
21 Ga	0.032	0.80
22 Ga	0.028	0.70
23 Ga	0.025	0.63
25 Ga	0.020	0.50
27 Ga	0.016	0.40

Color Code System**

Color code system is used to indicate vitreoretinal tips, their function and size.

Function	
Pink	Scissors
Green	Forceps
Gauge	
Gray	17
Pink	20
Green	23
Blue	25
Yellow	27
COMPATIBILITY (adjustable to handles)	
Pink	12-001T
Blue	12-001T / 12-003T

Manual Cleaning

Proper cleaning of the instrument is necessary to preserve its working condition.

RUMEX manufactures interchangeable microincisional and vitreoretinal instrument tips that can be cleaned with a regular syringe.



*Handles are sold separately! **Colors of details may differ slightly from those displayed in this catalog. Product design and/or features that do not influence its functionality and main parameters are subject to change

HANDLES FOR VITREORETINAL INSTRUMENTS*

RUMEX International Co is pleased to provide you with two models of Universal Handles that can be used with interchangeable tips.*

- Made of Titanium
- Corrosion resistant
- Can be used with tips of any gauge 20/23/25/27 (and other gauges)



Ergonomic Model

Two Fingers Control Squeeze Handle

12-003T **POPULAR**

- Two fingers linear actuation
- Ergonomic handle with specially designed gripping area for amplified control over the instrument
- Optimal diameter round handle allows 360° rotation
- Non compatible with the following tips: 12-206, 12-313, 12-321, 12-335

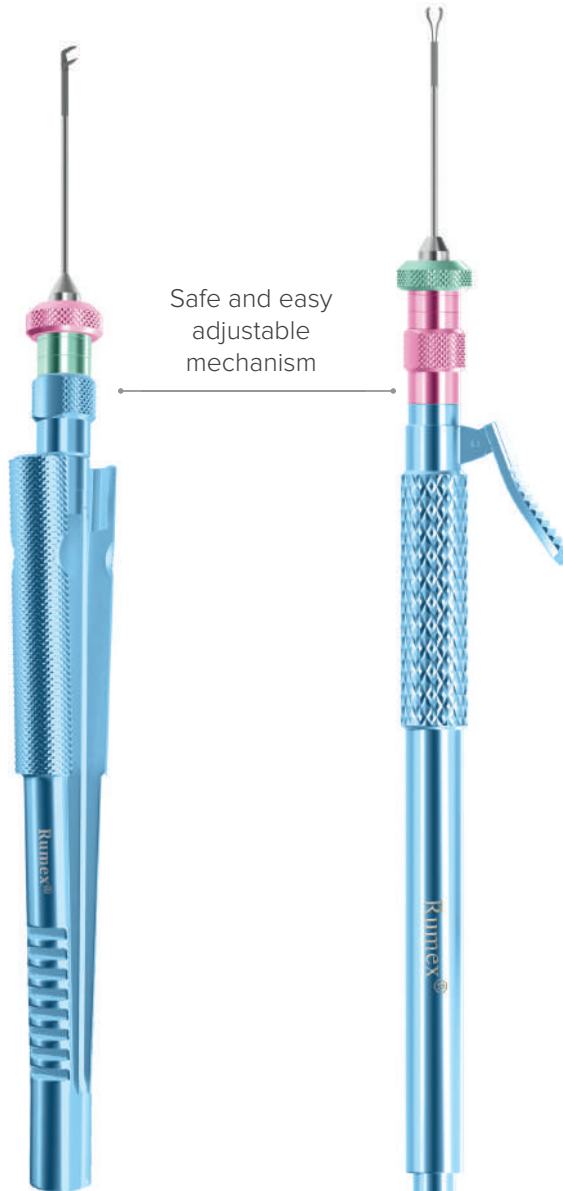

Classic Model

One Finger Control Handle

12-001T **POPULAR**

- One finger linear actuation
- Classic design approved by decades of work
- Compatible with all models of tips

Adjustable screw mechanism (to customize the opening of branches before manipulation)

*Tips are sold separately!

Product design and/or features that do not influence its functionality and main parameters are subject to change

SCISSORS*

Designed for cutting membranes and junction zones of the proliferative tissue.



**COMPATIBLE
WITH 12-003T ONLY**



Vertical Scissors

70°
Sharp tips

12-202 20 Ga
12-202-23 23 Ga **POPULAR**

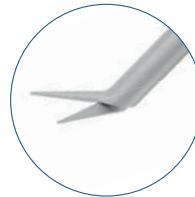

Horizontal Scissors

55°
12-206** 20 Ga



Klaus Lucke Retinotomy Scissors

With bulbous tip
12-2020 20 Ga



Horizontal Scissors

Angled
45°
Short blades (1.70 mm in the closed position)
12-2085 20 Ga



Vertical Scissors

45°
12-2029 25 Ga



Curved Subretinal Scissors

Curvature radius 12.00 mm
12-209 20 Ga
12-209-23 23 Ga **POPULAR**
12-2099 25 Ga



Straight Scissors

Blunt tips
12-211 20 Ga



Horizontal Scissors

Angled
45°
With illumination
12-2084 20 Ga



Side Curved Scissors

12-215 20 Ga

*Tips are sold separately!

** Compatible with Universal Handle 12-001T Only

Product design and/or features that do not influence its functionality and main parameters are subject to change

INTERNAL LIMITING MEMBRANE (ILM) FORCEPS

Delicate branches for ILM peeling



ILM



Asymmetrical End-Grasping Forceps

Standard tube, 28.00 mm

- 12-420-23 23 Ga **POPULAR**
- 12-420-25 25 Ga **POPULAR**
- 12-420-27 27 Ga

Designed for myopic eyes.
Elongated tube, 30.00 mm

12-4202-23 23 Ga

Enhanced visualization!



ILM

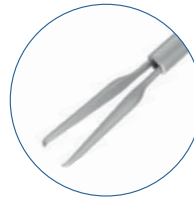

Eckardt End-Gripping Forceps

- 12-410 20 Ga
- 12-410-23 23 Ga **POPULAR**
- 12-410-25 25 Ga **POPULAR**
- 12-410-27 27 Ga

ILM



Tano Asymmetrical End-Gripping Forceps

- 12-411 20 Ga
- 12-411-23 23 Ga
- 12-411-25 25 Ga

Universal End-Grasping Forceps allow the performing of ILM peeling and safe removal of epiretinal membranes. Asymmetrical design of branches provides for ideal maneuverability and excellent visualization of the grasped tissue.

ILM



End-Grasping Forceps

Expanded space between branches

- 12-4013 23 Ga **POPULAR**

Enhanced visualization!



Tanaka Maculorhexis Forceps

- 12-414 23 Ga

The special design of the tips promotes delicate, precise and safe ILM peeling. The strengthened jaws ensure enhanced gripping power. Expanded space between branches contributes to greater visualization of the grasped membrane in the macular area.



Kawai ILM Forceps

- 12-415 25 Ga

*Tips are sold separately!

Product design and/or features that do not influence its functionality and main parameters are subject to change

EPIRETINAL FORCEPS*

- Strengthened jaws for the removal of epiretinal membranes
- Gripping function is enhanced by sandblasted/serrated platform or nail shaped jaws



ERM



Gripping Forceps

With a sandblasted platform

12-301	20 Ga	
12-301-23	23 Ga	POPULAR
12-3019	25 Ga	



ERM

End-Gripping Forceps

With serrated micro jaws

12-400	20 Ga
--------	-------



ERM

Lucke Multipurpose Forceps

12-3044	20 Ga
---------	-------

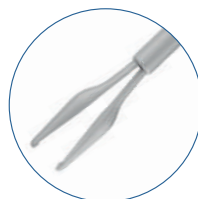

End-Gripping Forceps

With extended gripping area at the end of the tip

12-401	20 Ga
12-4012	23 Ga



ERM

Gripping Forceps

With a "crocodile" platform

12-304	20 Ga	
12-304-23	23 Ga	POPULAR
12-304-25	25 Ga	



End-Gripping Forceps

With nail-shaped jaws

12-402	20 Ga	
12-402-23	23 Ga	POPULAR
12-4089	25 Ga	

Designed for the removal of epiretinal membranes. Blunt, atraumatic serration intensifies grasping capacity and prevents tissue shredding.

*Tips are sold separately!

Product design and/or features that do not influence its functionality and main parameters are subject to change

PICK FORCEPS*



Pick Forceps

- 12-325 20 Ga
- 12-325-23 23 Ga
- 12-3259 25 Ga



POPULAR
POPULAR



Diamondized Angled Gripping Forceps

- 12-303 20 Ga



De Juan Pick Forceps

- 12-413 20 Ga

FOREIGN BODY REMOVAL FORCEPS*

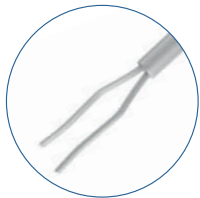

Avci Foreign Body Forceps

- 12-412*** 17 Ga

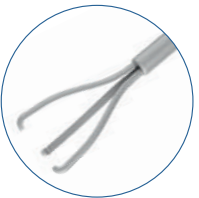

Spring Gripping Forceps

- 12-321** 20 Ga
- 12-321-23*** 23 Ga **POPULAR**

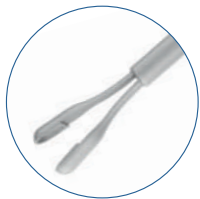

Vitreoretinal Forceps

- With cup jaws
- 12-313** 20 Ga



Stolyarenko Forceps

- For large foreign bodies
- 12-335** 20 Ga **POPULAR**

*Tip only. Handles are sold separately.
 ** Compatible with Universal Handle 12-001T only
 *** Compatible with Universal Handles 12-001T and 12-003T

Product design and/or features that do not influence its functionality and main parameters are subject to change

MEMBRANE INSTRUMENTS

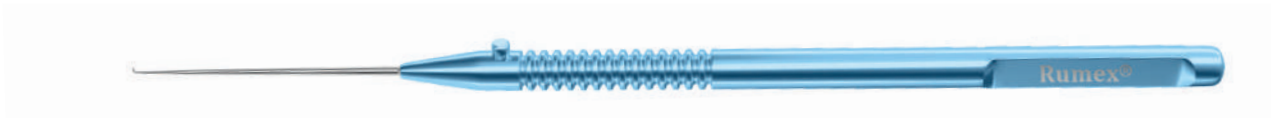

Delicate Membrane Pick

13-097-23 23 Ga **POPULAR**
 13-0979 25 Ga **POPULAR**
 13-097-27 27 Ga

Unique geometry of the tip for maximal effectiveness and minimal shredding of the tissue

Jut on the handle identifies the tip orientation



Membrane Scratcher

13-092 20 Ga

Flat, thin instrument to remove tissue and fine membranes from retinal surface in early stages of PVR

Useful for cleaning residual ERM or ILM

Great for lifting of large membrane edges without shredding

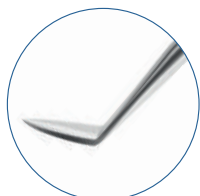
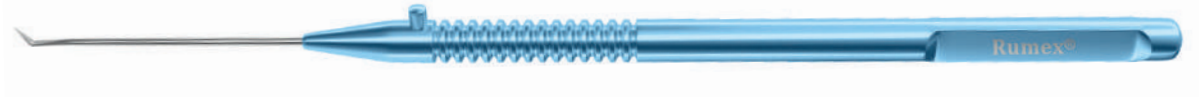

Ogura PVD Spatula

Overall length 132
 13-1081-23 23 Ga



BRVO Knife

Designed for performing a lateral CRVO incision.
 Overall length 135
 13-1091-23 23 Ga

23 GAUGE INSTRUMENTS*



ILM



Eckardt End-Gripping Forceps
 12-410-23 23 Ga **POPULAR**
 12-410-23D 12-410-23DP



Tano Asymmetrical End-Gripping Forceps
 12-411-23 23 Ga



Asymmetrical End-Grasping Forceps
 12-420-23 23 Ga **POPULAR**
 Enhanced visualization!
 12-420-23D



Asymmetrical End-Grasping Forceps
 Designed for myopic eyes. Elongated tube, 30.00 mm
 12-4202-23 23 Ga
 Enhanced visualization!



End-Grasping Forceps
 Expanded space between branches
 12-4013 23 Ga **POPULAR**
 Enhanced visualization!

ERM



Gripping Forceps
 With a sandblasted platform
 12-301-23 23 Ga **POPULAR**
 12-301-23D



Gripping Forceps
 With a "crocodile" platform
 12-304-23 23 Ga **POPULAR**
 12-304-23D 12-304-23DP



Vertical Scissors
 70°
 Sharp tips
 12-202-23 23 Ga **POPULAR**

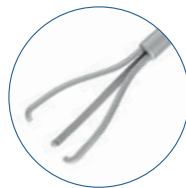

Spring Gripping Forceps
 12-321-23 23 Ga **POPULAR**



Pick Forceps
 12-325-23 23 Ga **POPULAR**
 12-325-23D

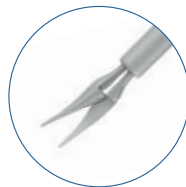

Curved Subretinal Scissors
 Curvature radius 12.00 mm
 12-209-23 23 Ga **POPULAR**
 12-209-23D 12-209-23DP

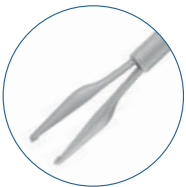

End-Gripping Forceps
 With extended gripping area at the end of the tip
 12-4012 23 Ga



End-Gripping Forceps
 With nail-shaped jaws
 12-402-23 23 Ga **POPULAR**

*Tip only. Handles are sold separately.

Product design and/or features that do not influence its functionality and main parameters are subject to change

25 GAUGE INSTRUMENTS*

ILM



Eckardt End-Gripping Forceps
12-410-25 25 Ga **POPULAR**



Tano Asymmetrical End-Gripping Forceps
12-411-25 25 Ga



Asymmetrical End-Grasping Forceps
12-420-25 25 Ga **POPULAR**
Enhanced visualization!

ERM



Gripping Forceps
With a sandblasted platform
12-3019 25 Ga



Gripping Forceps
With a "crocodile" platform
12-304-25 25 Ga **POPULAR**



Vertical Scissors
45°
Sharp tips
12-2029 25 Ga



Pick Forceps
12-3259 25 Ga **POPULAR**



Curved Subretinal Scissors
Curvature radius 12 mm
12-2099 25 Ga **POPULAR**



End-Gripping Forceps
With nail-shaped jaws
12-4089 25 Ga

27 GAUGE INSTRUMENTS*



ILM

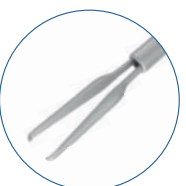

Eckardt End-Gripping Forceps
12-410-27 27 Ga



Asymmetrical End-Grasping Forceps
12-420-27 27 Ga
Enhanced visualization!

*Tip only. Handles are sold separately.

Product design and/or features that do not influence its functionality and main parameters are subject to change

ONE-PIECE VITREORETINAL INSTRUMENTS WITH FLUSHING SYSTEM

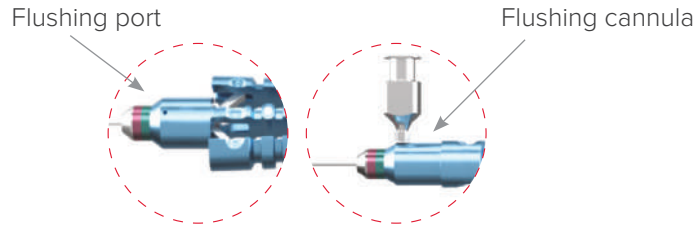
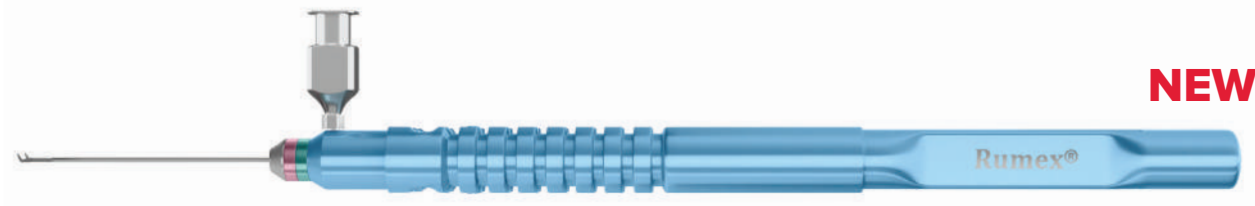

The tip can be easily cleaned without disassembling.
Special flushing cannula is provided for free!

ILM



Eckardt End-Gripping Forceps
 12-410-23H 23 Ga
 12-410-25H 25 Ga



Asymmetrical End-Grasping Forceps
 12-420-23H 23 Ga
 12-420-25H 25 Ga



Tano Asymmetrical End-Gripping Forceps
 12-411-23H 23 Ga
 12-411-25H 25 Ga



End-Grasping Forceps
 Expanded space between branches
 12-4013H 23 Ga
 12-4013-25H 25 Ga

Enhanced visualization!

ERM



Gripping Forceps
 With a "crocodile" platform
 12-304-23H 23 Ga
 12-304-25H 25 Ga

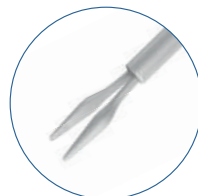

Gripping Forceps
 With a sandblasted platform
 12-301-23H 23 Ga
 12-301-25H 25 Ga



Pick Forceps
 12-325-23H 23 Ga
 12-325-25H 25 Ga

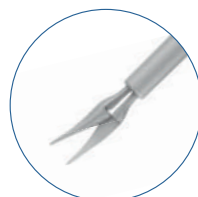

Curved Subretinal Scissors
 Curvature radius 12.00 mm
 12-209-23H 23 Ga
 12-209-25H 25 Ga

REUSABLE TWO STEP TROCAR SYSTEMS

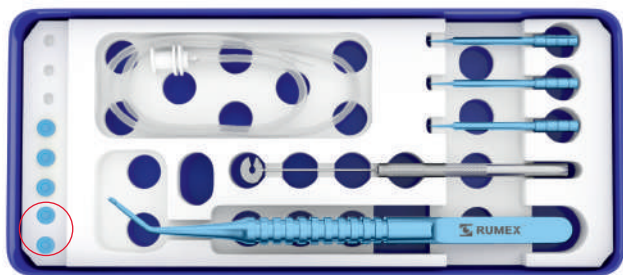

2 extra cannulas

MVR knives should be purchased separately



Loading Forceps

12-5186 23/25 Ga



Instrument Cannula Inserter

12-5187 23 Ga
12-5187-25 25 Ga



Fixation Plate

12-5188 23/25 Ga



MVR Knives

Multifacet blade



Straight

Angled

VRS-19 - 19 Ga
VRS-20 - 20 Ga
VRS-23 - 23 Ga

VRA-19 - 19 Ga
VRA-20 - 20 Ga
VRA-23 - 23 Ga



Scleral Plugs Forceps

Cross-action mechanism reduces hand fatigue.
Overall length 106 mm

12-5086S 20 Ga



Watzke Sleeve Spreading Forceps

Used to stretch the silicone sleeve placed around the eyeball.

Serrated tips aid in gripping the sleeve and allow for adjustable traction.

Overall length 110 mm

4-2201T

DISPOSABLE ONE-PIECE STAINLESS STEEL INSTRUMENTS

STERILE **2** **6** PER BOX

All stainless steel disposable instruments in 23 and 25 Ga are designed for precise manipulations during posterior segment surgeries.

The instruments are supplied sterile in a box of 6.



ILM



Eckardt End-Gripping Forceps

12-410-23D 23 Ga **POPULAR**
12-410-25D 25 Ga

ERM



Gripping Forceps

With a "crocodile" platform

12-304-23D 23 Ga
12-304-25D 25 Ga

ILM



Asymmetrical End-Grasping Forceps

12-420-23D 23 Ga
12-420-25D 25 Ga

Pick Forceps



12-325-23D 23 Ga
12-325-25D 25 Ga

ERM



Gripping Forceps

12-301-23D 23 Ga
12-301-25D 25 Ga

Curved Scissors



12-209-23D 23 Ga
12-209-25D 25 Ga

DISPOSABLE INSTRUMENTS WITH PLASTIC HANDLE*

STERILE **2** **6** PER BOX

NEW

360-degree handle design incorporates a unique rotatability, convenience and actuation. The instrument's weight is less than 8 grams. Lightweight plastic ergonomic handle especially valuable during hours-long surgeries.

- 23 Ga
- 25 Ga
- 27 Ga

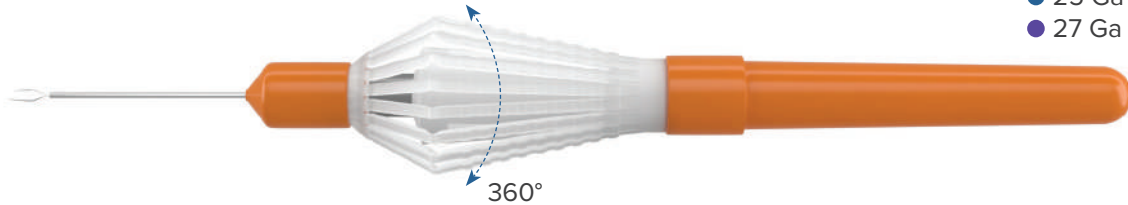

ILM

Eckardt End-Gripping Forceps

- 12-410-23DP 23 Ga
- 12-410-25DP 25 Ga
- 12-410-27DP 27 Ga

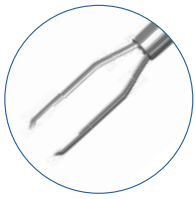

ERM

Gripping Forceps

With a "crocodile" platform

- 12-304-23DP 23 Ga
- 12-304-25DP 25 Ga
- 12-304-27DP 27 Ga

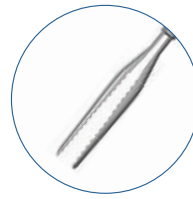

Curved Scissors

- 12-209-23DP 23 Ga
- 12-209-25DP 25 Ga
- 12-209-27DP 27 Ga



Straight Scissors

- 12-211-23DP 23 Ga
- 12-211-25DP 25 Ga
- 12-211-27DP 27 Ga



Vertical Scissors

- 45°
- 12-202-23DP 23 Ga
 - 12-202-25DP 25 Ga



DISPOSABLE DIAMOND DUSTED RETRACTABLE ILM ELEVATORS**

STERILE **2** **5** PER BOX

NEW

Designed to consistently create a precise edge to facilitate the ILM removal with forceps.

Diamond dusted soft silicone tip provides an extreme grip

Retractable version allows for easy insertion through the trocar cannula and helps to adjust the length of the tip



- 12-7523 23 Ga
- 12-7525 25 Ga



*Not available in the US and Europe

** Not available in Europe

Product design and/or features that do not influence its functionality and main parameters are subject to change

DISPOSABLE ONE STEP TROCAR SYSTEMS*

NEW STERILE  

VITREORETINAL INSTRUMENTS AND CONSUMABLES

Each set includes:

- Trocar knife with preloaded trocar cannula – 3 pcs
- Self-sealing trocar cannula (preloaded) – 3 pcs
- Universal infusion line – 1 pc

12-5229	23 Ga	●
12-5244	25 Ga	●
12-5227	27 Ga	●



Sharp MVR Blade

Helps to create a smooth incision and promotes low-pressure insertion and superior sealing

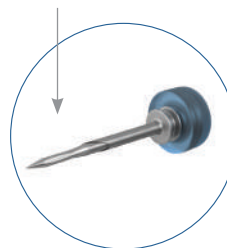

Trocar Cannula

Innovative sharp design of the cannula contributes to unstoppable smooth trocar insertion.

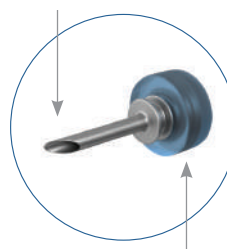

Silicone Closure Valves

Removable self-sealing valves ensure maintenance of the desired intraocular pressure (IOP) throughout the case and eliminate the need for plugs.

Trocar Cannula Inserter

The tip of the plastic handle serves as a caliper/ scleral marker (2 dimensions: 3 and 4 mm).

Universal Infusion Line for BSS



*Not available in Europe

Product design and/or features that do not influence its functionality and main parameters are subject to change

DISPOSABLE BACKFLUSH INSTRUMENTS*

STERILE **2** **6** PER BOX

NEW

One-piece instrument combines a handle and a soft, brush or blunt tip cannula. The set comes with two connectors for active and passive aspiration. Used for intraocular fluids and debris aspiration during vitreoretinal surgery.

- 23 Ga
- 25 Ga
- 27 Ga

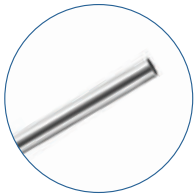

with **Blunt Tip**

- 12-5164H 23 Ga x 34 mm
- 12-5156H 25 Ga x 34 mm
- 12-5492H 27 Ga x 34 mm



with **Silicone Brush Tip**

- 12-5162H 23 Ga x 34 mm
- 12-5160H 25 Ga x 34 mm
- 12-5167H 27 Ga x 34 mm

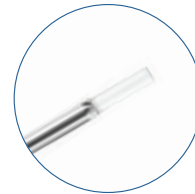

with **Silicone Soft Tip**

- 12-5161H 23 Ga x 34 mm
- 12-5152H 25 Ga x 34 mm
- 12-5491H 27 Ga x 34 mm

BACKFLUSH HANDLES AND RESERVOIRS



Reusable Backflush Handle

Titanium

- 12-6000 Active aspiration **POPULAR**
- 12-6010 Passive aspiration **POPULAR**

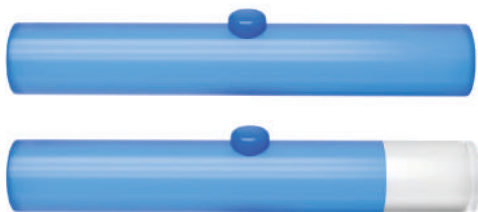

STERILE **2** **5** PER BOX

Disposable Replacement Reservoir for Backflush Handle*

- 12-5159 Active aspiration
- 12-5147 Passive aspiration

*Not available in Europe

Product design and/or features that do not influence its functionality and main parameters are subject to change

VITREORETINAL CANNULAS

Disposable Backflush Cannulas*

STERILE

2

5
PER
BOX

Designed for efficient and safe manipulations in the posterior segment. Used with the backflush handle.

Charles Flute Cannulas

Designed to aspirate blood and debris from the posterior segment. Smooth, finished tip provides atraumatic entry and reduces risk of trauma to surrounding tissue.

- 12-5164 23 Ga x 34 mm
- 12-5156 25 Ga x 34 mm
- 12-5492 27 Ga x 34 mm

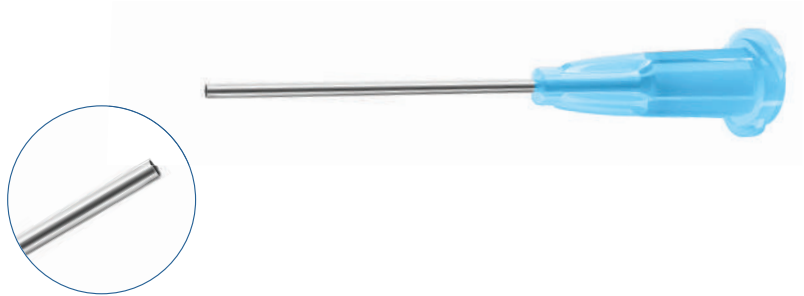

Soft Tip Cannulas

Flexible silicone tip allows atraumatic entry through retinal or macular tears or holes and enables aspiration of subretinal fluid.

- 12-5161 23 Ga x 34 mm
- 12-5152 25 Ga x 34 mm
- 12-5491 27 Ga x 34 mm



Brush Tip Cannulas

The soft silicone brush tip cannula designed for atraumatic brushing of retina.

- 12-5162 23 Ga x 34 mm
- 12-5160 25 Ga x 34 mm
- 12-5167 27 Ga x 34 mm



STERILE

2

5
PER
BOX

Dual Bore Cannulas*

Dual Bore PFC Cannulas

Simultaneous infusion of heavy liquids and aspiration of intraocular fluids.

- 12-5203 23 Ga x 33 mm
- 12-5205 25 Ga x 33 mm

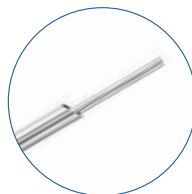

*Not available in Europe

Product design and/or features that do not influence its functionality and main parameters are subject to change

SILICONE OIL

Smartsil 1000/5000*

Purified Silicone Oil for Vitreoretinal Surgery

- Maximum interfacial tension and minimum interactions between tissues, cells and endo-tamponades media
- Optimal combination of specific gravity, refractive index and surface tension
- Different viscosity indexes enable easy injection (1000 cSt) and stable temporary tamponade (5000 cSt)
- Vacuum molecular distillation solvent-free purification - **no risk of emulsification**

Physico-chemical properties

Interfacial tension	≥ 40 mNm ⁻¹ at 37°C
Density	0.97
Viscosity	1000/5000 cSt
Refractive index	1.40
Volatility	< 1%
Polydispersity	< 2.80
Volume of oil	10 ml
Syringe	20 ml
Shelf Life	3 years

GC

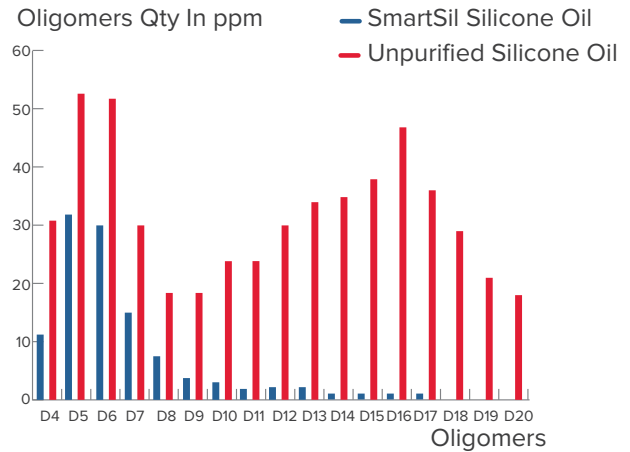

Silicone Oil Infusion System is sold separately



Purification

- Vacuum molecular distillation solvent-free purification
- Potentially toxic low molecular weight oligomers (D4 to D20) extraction
- Residual volatile components extraction (water, ethanol, etc.)

Indication

SmartSil 1000/5000 is used for prolonged tamponade after surgical treatment for severe retinal detachment (RD), especially:

- RD with proliferative vitreal retinopathy
- RD with diabetic retinopathy complications
- RD with giant tears
- Traumatic RD
- Secondary RD with viral retinitis

*Not available in the US

*To be used with Silicone Oil Infusion System

Product design and/or features that do not influence its functionality and main parameters are subject to change



SILICONE OIL INFUSION SYSTEMS

Silicone Oil Infusion Systems are used to connect RUMEX silicone oil syringe to the vitreoretinal surgical equipment.



Surgical System	Reusable
Ioltech® Pentasys™ Optikon® Antares™ Alcon® STTO™ Storz® Premiere™ DORC® Harmony Budget™	12-RTUB-1
DORC® Associate™ Alcon® Constellation™, Accurus™	12-RTUB-2
B&L® Millenium™, Stellaris™	12-RTUB-3
Oertli® Orbit™, Faros™, OS3™ Optikon® R-Evolution®	12-RTUB-4

STERILE



Disposable Viscous Fluid Injection Cannulas*

Allow injection of viscous fluids such as silicone oil through a 23 Ga or 25 Ga trocar cannula

- 12-5248 23 Ga x 4 mm
- 12-5258 25 Ga x 4 mm

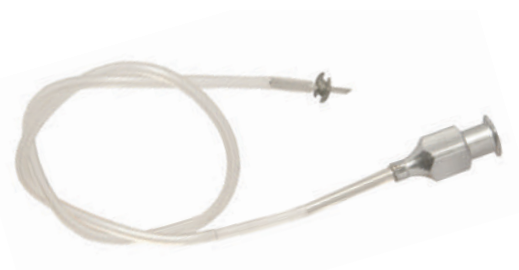

Infusion Cannula

Reusable Infusion Cannula

Self-retaining hub of 6.00 mm

- 12-026 20 Ga

STERILE



Disposable Self-Retaining Silicone Oil Cannula

Self-retaining hub of 4.00 mm

- 12-5165 23 Ga

*Not available in Europe

Product design and/or features that do not influence its functionality and main parameters are subject to change

POPULAR

SKU preferred by the majority of customers

NEW

Recently introduced into the product range of RUMEX International Co.



Disposable instruments



Available in a single-use edition



Available in Stainless Steel



Featured instrument in the set on page 100

**DON'T FORGET
TO BUY**

Frequently bought together



Quantity in the box

FEATURED SETS

CATARACT	154
REFRACTIVE	158
CORNEAL	161
GLAUCOMA	164
PTERYGIUM	165
CHALAZION	166
LACRIMAL	167
LID	168
MUSCLE	169
OCULOPLASTIC	170
VITREORETINAL	172

PHACOEMULSIFICATION SET

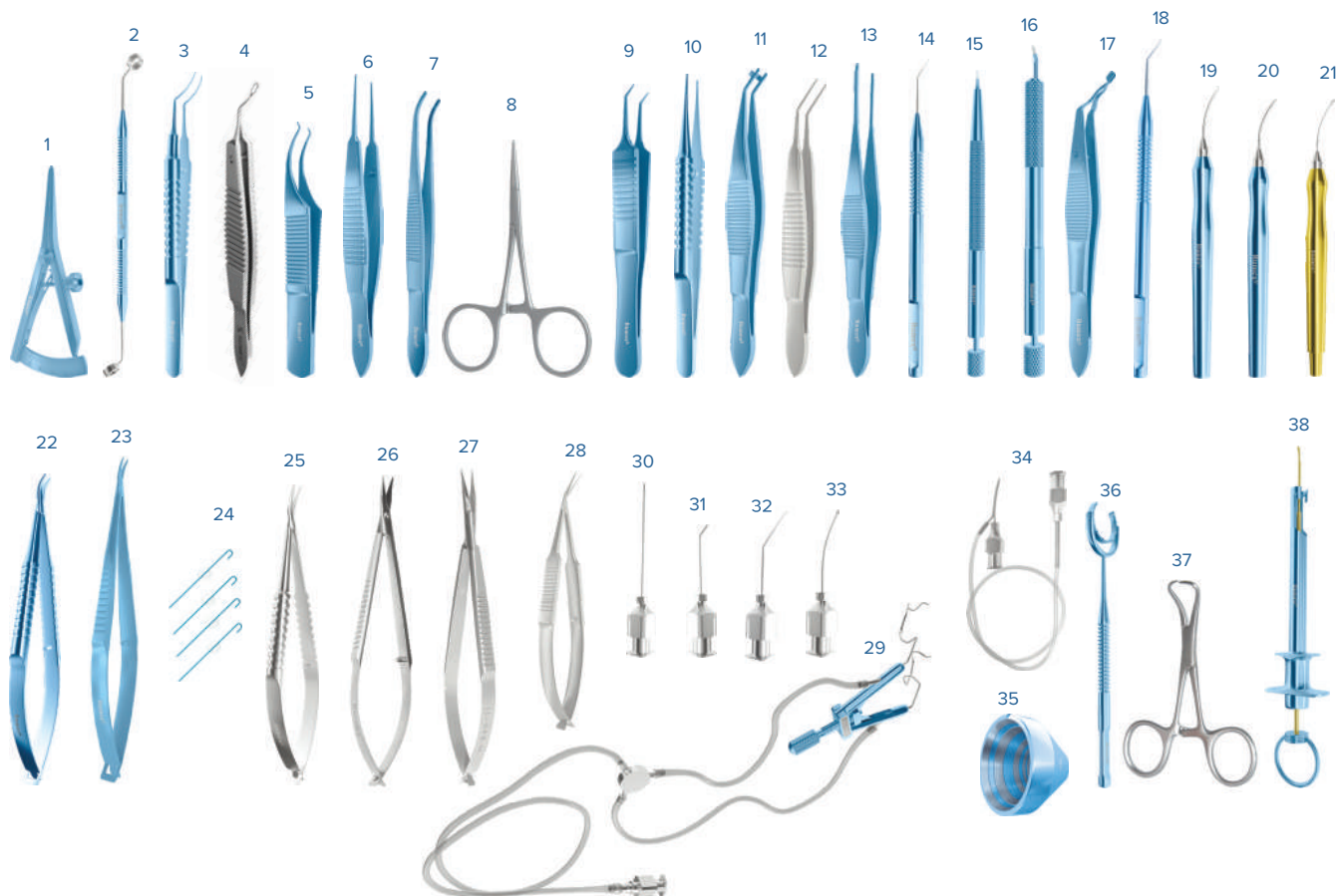

Reference	Key	Description	Page	Reference	Key	Description	Page
2-010T	1	Castroviejo Caliper	37	7-081	20	Irrigation Handpiece for Bimanual Technique, 21 Ga	85
3-040	2	Whipple Capsulorhexis Centration Marker	39	7-0821	21	Aspiration Handpiece for Bimanual Technique, 22 Ga	86
4-03315T	3	Ultrata Capsulorhexis Forceps, Cystotome Tips, with Scale	48	8-031T	22	Barraquer Needle Holder, Standard Jaws, without Lock	88
4-033S	4	Small-incision Capsulorhexis Forceps with Double Cross-Action and Scale	49	8-096T	23	Castroviejo Needle Holder, Delicate Jaws, without Lock	87
4-050T	5	Colibri Corneal Forceps	57	10-5016-1	24	Disposable Iris Retractors, 1 Pack of 4 pcs	91
4-0600T	6	Castroviejo Suturing Forceps	68	11-034S	25	Universal Corneal Scissors	92
4-072T	7	Dressing Forceps with Serrations	60	11-040S	26	Westcott Tenotomy Scissors	95
4-120S	8	Hartman Hemostatic Mosquito Forceps	67	11-044S	27	Westcott Stitch Scissors	94
4-174T	9	McPherson Angled Tying Forceps	69	11-0581S	28	Gills-Vannas Capsulotomy Scissors	96
4-185T	10	Tennant Straight Tying Forceps	70	14-080A	29	Lieberman Temporal Speculum with Aspiration	108
4-2107T	11	Steinert Paddle Lens Folding Forceps	62	15-025	30	Kelman Sharp Irrigating Cystotome, 25 Ga	116
4-2108S	12	Faulkner Lens Holding Forceps	62	15-051-27	31	Rycroft Anterior Chamber Cannula, 27 Ga	113
4-2141T	13	Cartridge Loading Forceps, for Inserting IOL	63	15-071-25	32	McIntyre Nucleus Hydrodissector, Spatulated, 25 Ga	115
5-030	14	Kuglen Iris Hook, Angled	71	15-170	33	Microincisional Capsule Polisher Cannula, Disc-Shaped Tip, 23 Ga	116
5-032*		Sinsky Hook, Angled	71	15-129-0.3	34	Simcoe I/A Cannula, 23/23 Ga	114
5-034*		Bechert Nucleus Rotator	71	16-020T	35	Maloney Intraoperative Keratometer	37
6-10/6-053	15	Diamond Knife, Trifacet Blade, 1.00 mm	74	16-0341T	36	Fine Thornton Fixation Ring with Swivel	120
6-20/6-107	16	Diamond Knife, Self-Diving Trapezoid Blade, 2.00/2.30 mm	75	16-081S	37	Towel Forceps	70
7-025T	17	Ernest Nucleus Cracker	78	16-2806	38	IOL Injector for A, B, C Cartridges	120
7-063 (7-064*)	18	Nagahara Phaco Chopper RHD (LHD*)	80	18-305*		Plastic Sterilization Tray with Silicone Finger Mat, Double Level, Extra Large	125
7-0634/I	19	Lesieur Hydrochopper, 20 Ga	84				

*not shown

PHACO PRECHOP SET

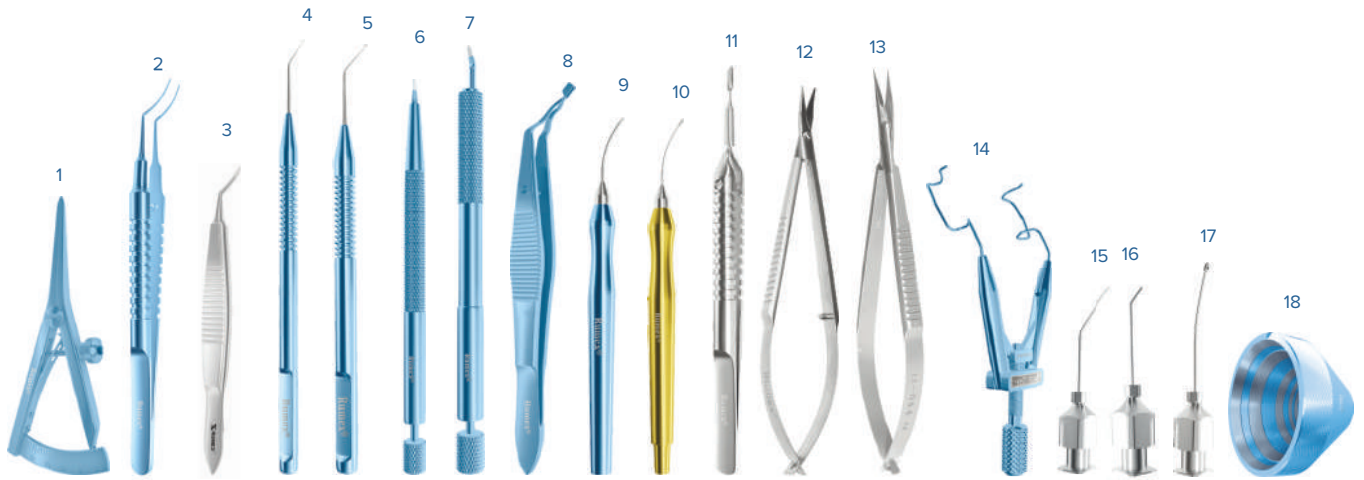

Reference	Key	Description	Page	Reference	Key	Description	Page
2-010T	1	Castroviejo Caliper	37	7-1161S	11	Combo Prechopper (Sharp & Blunt Blades)	79
4-03315T	2	Utrata Capsulorhexis Forceps with Scale	48	11-040S	12	Westcott Tenotomy Scissors	95
4-032S	3	Small-incision Capsulorhexis Forceps with Limiter	45	11-044S	13	Westcott Stitch Scissors	94
5-030	4	Kuglen Hook	71	14-040T	14	Lieberman Temporal Speculum	110
5-032	5	Sinsky Hook	71	15-071-25	15	McIntyre Nucleus Hydrodissector, 25 Ga	115
6-10/6-053	6	Diamond Knife, Trifacet Blade, 1.00 mm	74	15-051-27	16	Rycroft Anterior Chamber Cannula, 27 Ga	113
6-20/6-104	7	Diamond Knife, Self-Diving Trapezoid Blade, 2.30/2.80 mm	75	15-159-25	17	Jensen Capsule Polisher, Curved, Olive Tip, 25 Ga	116
7-025T	8	Ernest Nucleus Cracker	78	16-020T	18	Maloney Intraoperative Keratometer, Titanium	37
7-081	9	Irrigation Handpiece for Bimanual Technique, 21 Ga	85	18-304*		Plastic Sterilization Tray with Silicone Finger Mat, Extra Large	125
7-0821	10	Aspiration Handpiece for Bimanual Technique, 22 Ga	86				

*not shown

BIMANUAL MICROPHACO (MICS)

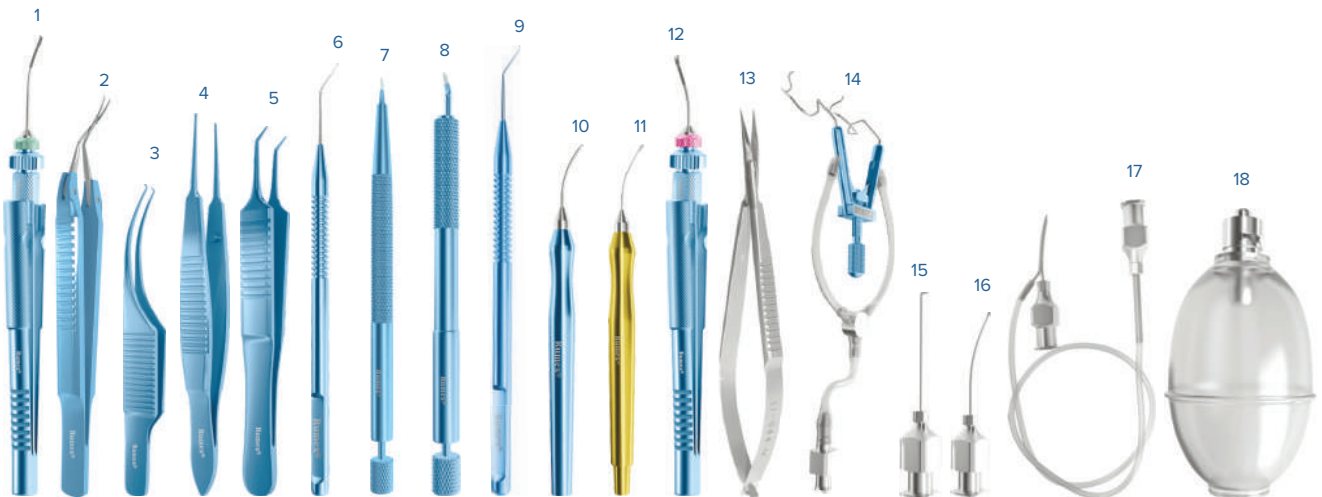

Reference	Key	Description	Page	Reference	Key	Description	Page
4-03771/12-003T	1	Kawai Capsulorhexis Forceps, Tapered 23/25 Ga shaft/ Universal Squeeze Handle	53/135	7-081	10	Irrigation Handpiece for Bimanual Technique, 21 Ga	85
4-0395	2	Capsulorhexis Forceps with Scale, Cross-Action	46	7-0821	11	Aspiration Handpiece for Bimanual Technique, 22 Ga	86
4-0501T	3	Colibri Corneal Forceps, 0.12 mm 1x2 Teeth	57	11-03741	12	Side Port Capsulotomy Scissors, Left, 20 Ga	96
4-0600T	4	Castroviejo Suturing Forceps, 0.12 mm 1x2 Teeth	68	11-03751*/12-003T		Side Port Capsulotomy Scissors, Right, 20 Ga /Universal Squeeze Handle	96/135
4-174T	5	McPherson Angled Tying Forceps	69	11-044S	13	Westcott Stitch Scissors	94
5-032	6	Sinsky Hook	71	14-080A	14	Lieberman Temporal Speculum with Aspiration	108
5-034*	7	Bechert Nucleus Rotator	71	15-0681	15	Chang Nucleus Hydrodissector, 27 Ga	115
6-10/6-053	8	Diamond Knife Trifacet Blade, 1.00 mm	74	15-170	16	Microincisional Capsule Polisher Cannula, Disc-Shaped Tip, 23 Ga	116
6-20/6-144	9	Diamond Knife, Self-Diving Trapezoid Blade, 1.80/2.00 mm	75	15-129-0.3	17	Simcoe I/A Cannula, 23/23 Ga	114
7-063 (7-064*)		Nagahara Phaco Chopper RHD (LHD*)	80/80	15-301/303	18	Silicone Bulb with Adapter	118
				18-304*		Plastic Sterilization Tray with Silicone Finger Mat, Extra Large	125

*not shown

Product design and/or features that do not influence its functionality and main parameters are subject to change

EXTRA CAPSULAR CATARACT EXTRACTION (ECCE) SET

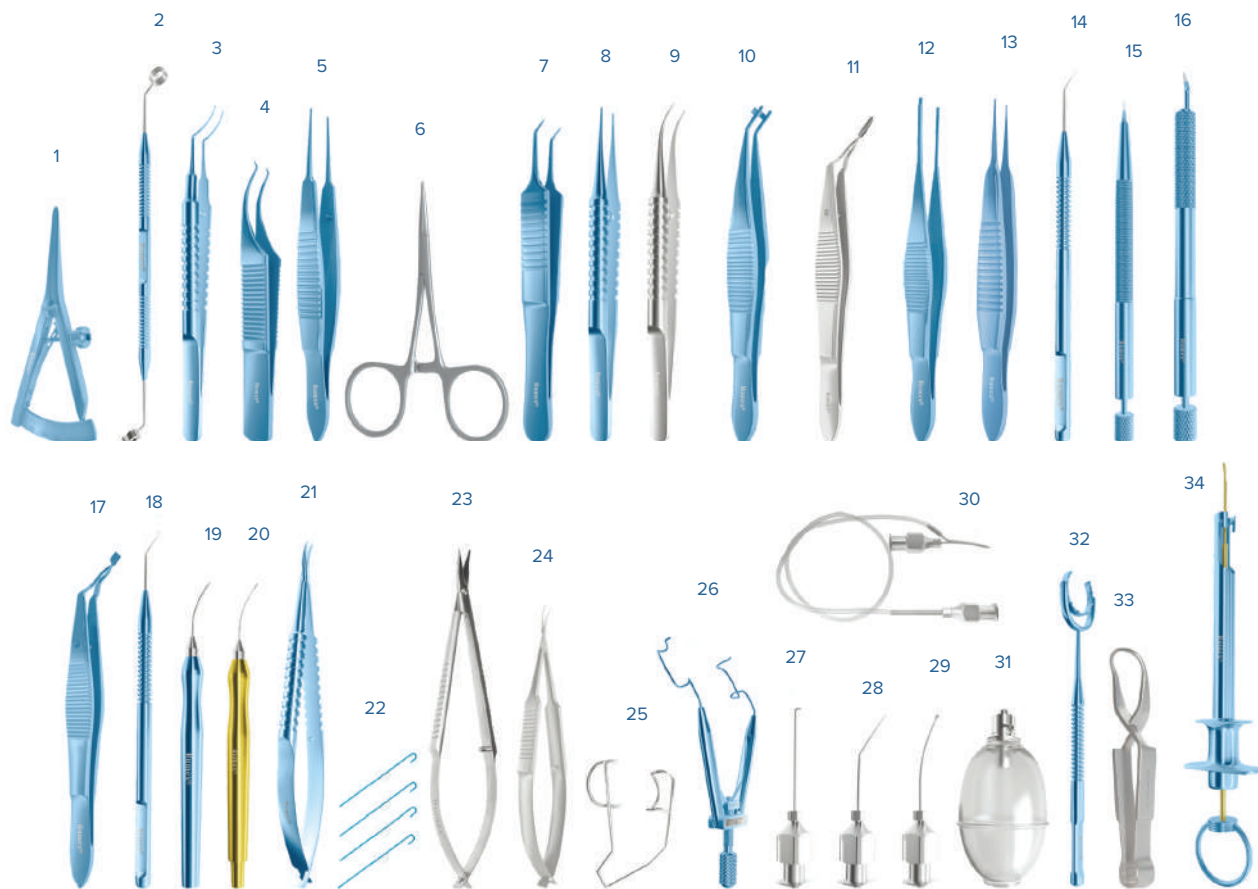

Reference	Key	Description	Page
2-010T	1	Castroviejo Caliper	37
3-040	2	Whipple Capsulorhexis Centration Marker	39
4-03315T	3	Utrata Capsulorhexis Forceps with Ruler	48
4-050T	4	Colibri Corneal Forceps, 0.12 mm 1x2 Teeth	57
4-0600T	5	Castroviejo Suturing Forceps, 0.12 mm 1x2 Teeth	68
4-120S	6	Hartman Mosquito Forceps, Straight	67
4-174T	7	McPherson Angled Tying Forceps	69
4-185T	8	Tennant Straight Tying Forceps	70
4-186S	9	Tennant Curved Tying Forceps	70
4-2107T	10	Steinert Paddle Lens Folding Forceps	62
4-2113S	11	McDonald Style Inserting Forceps	62
4-2141T	12	Cartridge Loading Forceps	63
4-2301T	13	Fechtner Conjunctiva Forceps	54
5-030	14	Kuglen Iris Hook	71
5-0331*		Lester Lens Manipulator	71
5-034*		Bechert Nucleus Rotator	71
6-10/6-053	15	Diamond Knife, Trifacet Blade, 1.00 mm	74
6-20/6-104	16	Diamond Knife, 2.30/2.80 mm, Self-Diving Trapezoid Blade	75

Reference	Key	Description	Page
7-025T	17	Ernest Nucleus Cracker	78
7-065	18	Rosen Phaco Chopper, Universal	80
7-081-23	19	Irrigation Handpiece for Bimanual Technique, 23 Ga	85
7-0821-23	20	Aspiration Handpiece for Bimanual Technique, 23 Ga	86
8-041T	21	Barraquer Needle Holder, Fine Jaws, without Lock	88
10-5016-1	22	Disposable Iris Retractors (1 Pack of 4 pcs)	91
11-040S	23	Westcott Tenotomy Scissors	95
11-058S	24	Gills-Vannas Capsulotomy Scissors	96
14-022S	25	Barraquer Wire Speculum, Adult Size	112
14-040TK	26	Lieberman Temporal Speculum, Adult Size	110
15-0681	27	Chang Nucleus Hydrodissector, 27 Ga	115
15-071-25	28	McIntyre Nucleus Hydrodissector, Spatulated, 25 Ga	115
15-170	29	Microincisional Capsule Polisher Cannula, Disc-Shaped Tip, 23 Ga	116
15-129-0.3	30	Simcoe I/A Cannula, 23/23 Ga	114
15-301/303	31	Silicone Bulb with Adapter	118
16-0341T	32	Fine Thornton Fixation Ring with Swivel	120
16-080S	33	Towel Clamp	70
16-2806	34	IOL Injector for A, B, C Cartridges	120
18-305*		Plastic Sterilization Tray with Silicone Finger Mat, Double Level, Extra Large	125

*not shown

FEMTOSECOND CATARACT SET

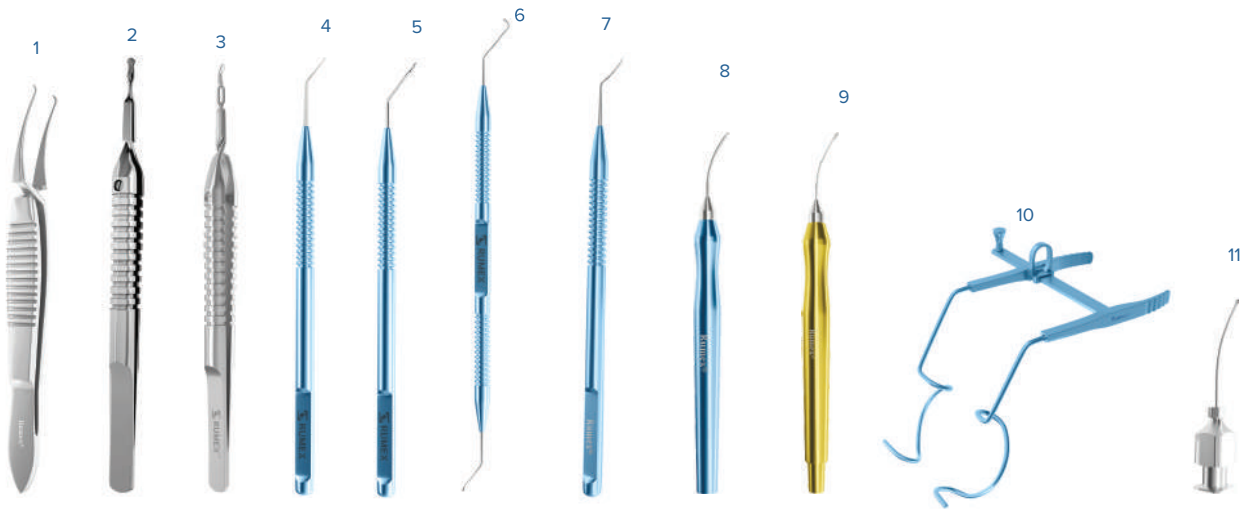

Reference	Key	Description	Page	Reference	Key	Description	Page
4-0582S	1	Forceps for Femtosecond Laser Cataract Procedure	53	7-081-23	8	Irrigation Handpiece for Bimanual Technique, 23 Ga	85
7-1166S	2	Yeoh Femtosecond Prechopper	79	7-0821-23	9	Aspiration Handpiece for Bimanual Technique, 23 Ga	86
7-149S	3	Escaf Prechopper	79	14-052T	10	Slade-Murdoch Speculum	110
7-1167S*		Crozafon Prechopper	79	15-170	11	Microincisional Capsule Polisher Cannula, Disc-Shaped Tip, 23 Ga	116
7-145	4	Nagy Femtosecond Chopper	83	18-304*		Plastic Sterilization Tray with Silicone Finger Mat, Extra Large	125
7-146	5	Donnenfeld Femto Splitter	83				
13-181	6	Uy Laser Lens Fragmentation Combo Manipulator	99				
20-204*		Spatula for Femtosecond Laser Procedure	99				
20-2041	7	Donnenfeld Femto Spatula	99				

*not shown

DISPOSABLE UNIVERSAL CATARACT SET

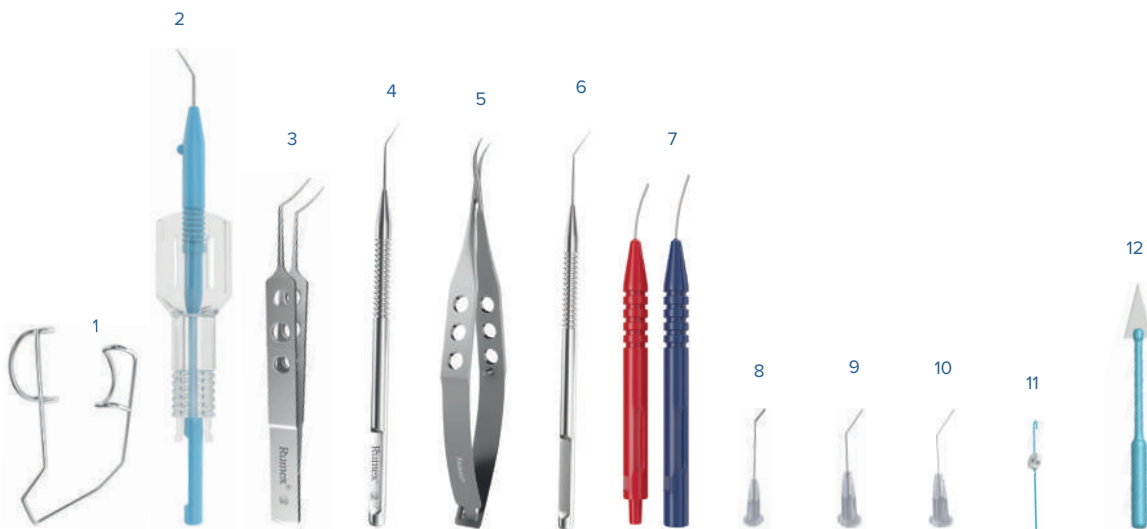

Reference	Key	Description	Page	Reference	Key	Description	Page
14-022D	1	Barraquer Wire Speculum, Adult Size	20	5-0331D*		Lester Lens Manipulator, Angled	20
CC-22	2	Clear Corneal Knife, Double Bevel, 2.20 mm, Angled	19	11-040D	5	Westcott Tenotomy Scissors, Curved, Blunt Tips	21
CC-24*		Clear Corneal Knife, Double Bevel, 2.40 mm, Angled	19	11-052D*		Vannas Capsulotomy Scissors, Curved, Sharp Tips	21
CC-27*		Clear Corneal Knife, Double Bevel, 2.75 mm, Angled	19	7-063D	6	Nagahara Phaco Chopper, RHD	20
SL-22*		Slit Knife, Single Bevel, 2.20 mm, Angled	18	7-065D*		Rosen Phaco Chopper, Universal	20
SL-24*		Slit Knife, Single Bevel, 2.40 mm, Angled	18	7-093D*		Drysdale Nucleus Manipulator, Angled	20
SL-28*		Slit Knife, Single Bevel, 2.80 mm, Angled	18	7-0821D	7	Set of I/A Handpieces, 21 Ga	22
SP-15*		Side-Port Knife, Double Bevel, 1.00 mm, 15°, Straight	18	7-0823D*		Set of I/A Handpieces, 23 Ga	22
4-0331D	3	Ultrata Capsulorhexis Forceps, Curved	21	21-R2027-8	8	Rycroft Anterior Chamber Cannula, 27 Ga	25
4-0311D*		Ultrata Capsulorhexis Forceps, Straight	21	21-R2227	9	Viscoelastic Cannula, 27 Ga	25
4-0551D*		Bonn-Catalano Corneal Forceps, 0.12 mm	21	21-R4027	10	Pearce Hydrodissector, Flattened, 27 Ga	26
4-0600D*		Castroviejo Suturing Forceps, 0.12 mm	21	10-5016-1	11	Iris Retractors	22
4-174D*		McPherson Tying Forceps, Angled	21	R2-40405	12	PVA Spears	22
5-032D	4	Sinsky Hook, Angled	20				
5-030D*		Kuglen Iris Hook, Angled	20				

*not shown

Product design and/or features that do not influence its functionality and main parameters are subject to change

TORIC IOL IMPLANTATION SET

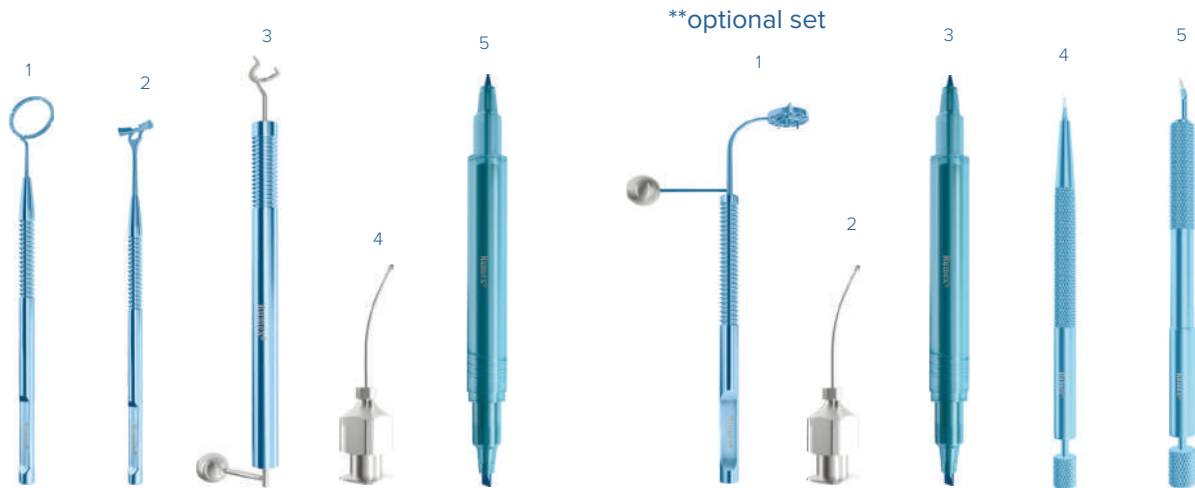

Reference	Key	Description	Page
2-034T	1	Grooved Fine Mendez Degree	38
3-091T	2	Bores Axis Marker	39
3-193	3	Whitehouse Gravity Axis Marker	43
15-170	4	Microincisional Capsule Polisher Cannula, Disc-Shaped Tip, 23 Ga	116
20-050	5	Disposable Marking Pen, Double-Ended, 10 per Box	44

*not shown

****optional set**

Reference	Key	Description	Page
3-194 (3-194)*	1	RUMEX Toric Combo Marker, Vertical 0-0 Axis (Horizontal 0-0 Axis)	43
15-170	2	Microincisional Capsule Polisher Cannula, Disc-Shaped Tip, 23 Ga	116
20-050	3	Disposable Marking Pen, Double-Ended, 10 per Box	44
6-10/6-053	4	Diamond Knife, Trifact Blade, 1.00 mm	74
6-20/6-144	5	Diamond Knife, Self-Diving Trapezoid Blade, 1.80/2.00 mm	75
18-304*		Plastic Sterilization Tray with Silicone Finger Mat, Extra Large	125

SMILE SET

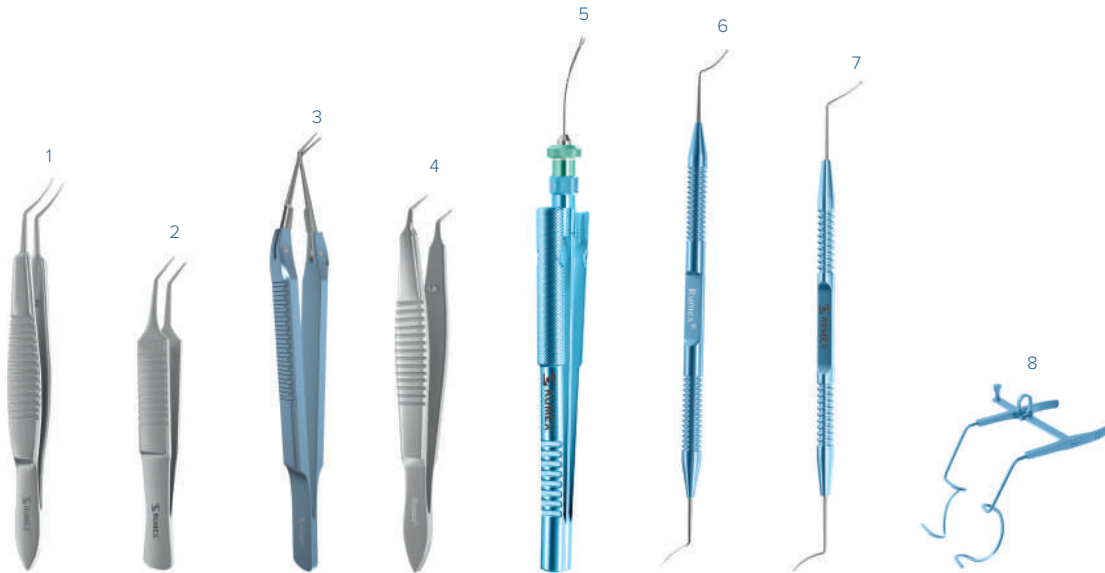

Reference	Key	Description	Page
4-266S	1	SMILE Lenticule Extraction Forceps with a View-Port	56
4-268S	2	SMILE Lenticule Extraction Forceps with Serrations	56
4-0398	3	Cross-Action SMILE Forceps	56
4-2012S	4	Stodulka Forceps for Small-Incision Lenticule Extraction	56
4-034/12-003T	5	Forceps for Corneal Endothelium Implantation, 23 Ga/ Universal Squeeze Handle	59 135

Reference	Key	Description	Page
20-207	6	Stodulka ReLEx Smile Double Lenticule Spatula (Blunt Spoon and Flat Spatula)	105
20-2071*		ReLEx Smile Double Lenticule Spatula (Blunt Spoon and Shortened Flat Spatula)	105
20-2073	7	SMILE Lenticule Removing Spatula	105
14-052T	8	Slade-Murdoch Speculum	110

Product design and/or features that do not influence its functionality and main parameters are subject to change

*not shown

FEMTOLASIK SET

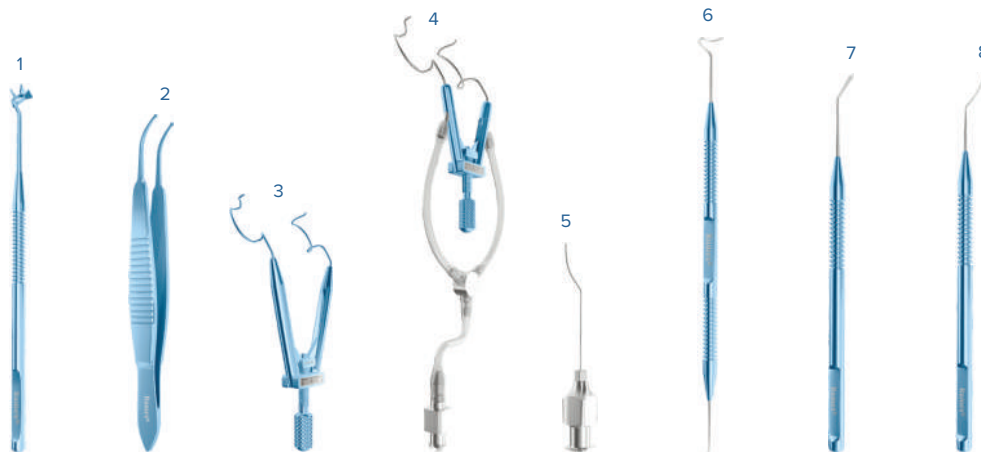

Reference	Key	Description	Page
3-176T	1	LASIK Flap Marker	41
4-2206T	2	LASIK Flap Forceps	55
14-040TL	3	Lieberman Temporal Speculum for LASIK	110
14-080LA	4	Lieberman Temporal Speculum with Aspiration for LASIK	108
15-379-25	5	Buratto LASIK Irrigation Cannula, 25 Ga	117

Reference	Key	Description	Page
20-201	6	FemtoLASIK Flap Spatula, Double-Ended	106
20-202	7	FemtoLASIK Flap Spatula	106
20-203	8	Zaldivar FemtoLASIK Spatula	106
18-304*		Plastic Sterilization Tray with Silicone Finger Mat, Extra Large	125

*not shown

LASIK SET

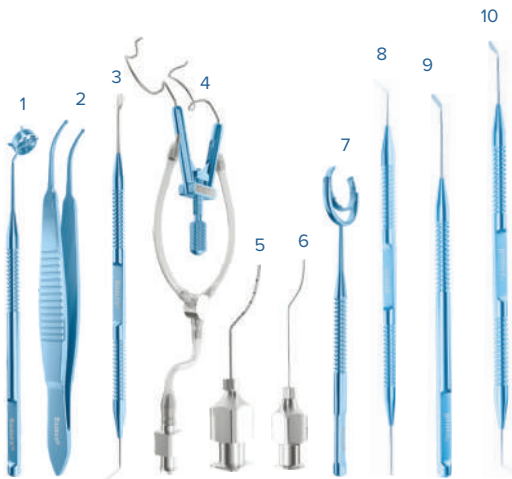

Reference	Key	Description	Page
3-174T	1	Lavery LASIK Marker	41
4-2206T	2	LASIK Flap Forceps	55
13-110	3	Paton Double-Ended Spatula and Spoon	99
14-080LA	4	Lieberman Temporal Speculum with Aspiration for LASIK	108
15-373-25	5	Banaji LASIK Irrigation Cannula, 25 Ga	117
15-376*		Slade LASIK Cannula, 26 Ga	117
15-379-25	6	Buratto LASIK Irrigation Cannula, 25 Ga	113
16-0341T	7	Fine Thornton Fixation Ring with Swivel	120
20-013	8	LASIK Spatula and Flap Retreatment Instrument	127
20-001	9	Hockey Epithelium Removal Knife	129
20-002	10	Lindstrom LASIK / PRK Spatula and Epithelium Removal Board	129
18-304*		Plastic Sterilization Tray with Silicone Finger Mat, Extra Large	125

*not shown

LASEK SET

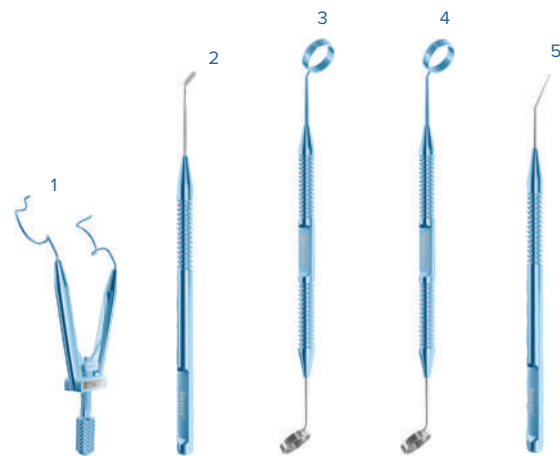

Reference	Key	Description	Page
14-040TL	1	Lieberman Temporal Speculum for LASIK	110
20-0011	2	LASEK Knife	127
20-121	3	LASEK 8.00 mm Trephine / 8.50 mm Funnel	129
20-122	4	LASEK 9.00 mm Trephine / 9.50 mm Funnel	129
20-131	5	LASEK Epithelial Micro Hoe	127
18-304*		Plastic Sterilization Tray with Silicone Finger Mat, Extra Large	125

LRI SET



Reference	Key	Description	Page	Reference	Key	Description	Page
2-034T	1	Grooved Fine Mendez Degree Gauge with 4 Grooves	38	3-183T	1	LRI Marker, Intra-Op, 30, 45 and 60°	42
3-091T	2	Bores Axis Marker	39	3-1932	2	Whitehouse Gravity Axis Marker with Reduced Diameters	43
3-1932	3	Whitehouse Gravity Axis Marker with Reduced Diameters	43	6-322/ 6-0531	3	Universal Three-Step Diamond Knife for Cataract and LRI Surgery	76
6-322/6-0531	4	Universal Three-Step Diamond Knife for Cataract and LRI Surgery	76	18-304*		Plastic Sterilization Tray with Silicone Finger Mat, Extra Large	125

*not shown

ICL SET

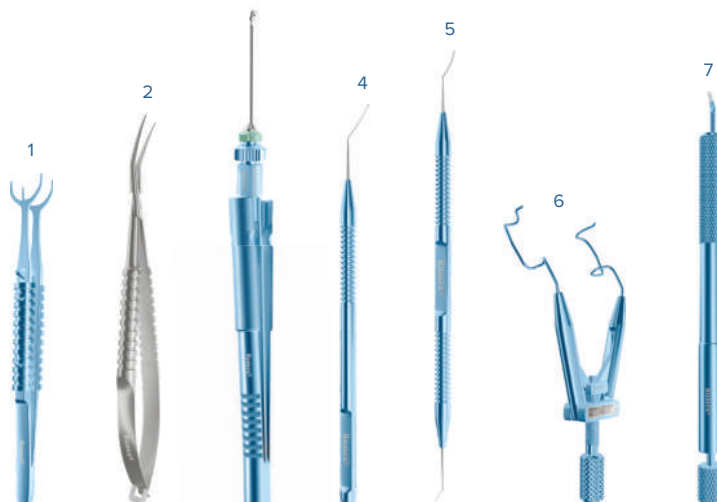

Reference	Key	Description	Page	Reference	Key	Description	Page
4-0801T	1	Nevyas-Wallace Fixation Forceps, 0.12 mm 1x2 Teeth	61	13-142	5	Zaldivar ICL™ Manipulator	107
4-2011S	2	ICL™ Cartridge Loading Forceps	65	14-040T	6	Lieberman Temporal Speculum	110
4-21432/12-003T	3	Zaldivar - Kraff ICL Pacman Forceps, 20 Ga, Tip Only	65	6-20/6-0551	7	Zaldivar Universal ICL™ Knife, 0.55/1.00 mm	75
13-141	4	Pallikaris ICL™ Manipulator	107	18-304*		Plastic Sterilization Tray with Silicone Finger Mat, Extra Large	125

*not shown

CORNEAL TRANSPLANTATION SET

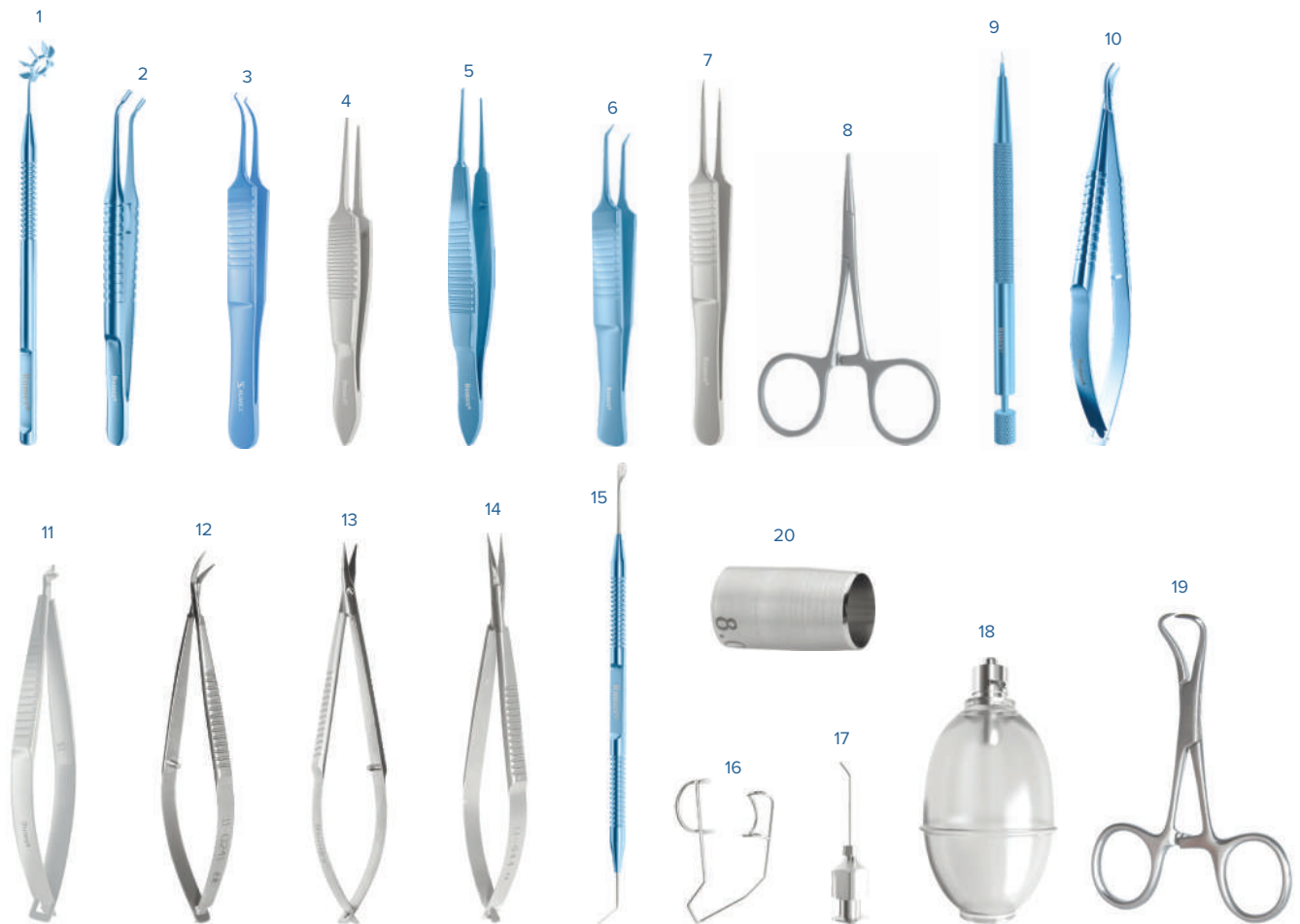

Reference	Key	Description	Page	Reference	Key	Description	Page
3-140T	1	Corneal Transplant Marker	40	11-020S	11	Katzin Corneal Transplant Scissors, Left	92
4-0814T	2	Pollack Corneal Transplantation Fixation Forceps	61	11-0201S*	12	Katzin Corneal Transplant Scissors, Right	92
4-0541T	3	Castroviejo Colibri Corneal Forceps	58	11-024S	12	Castroviejo Corneal Section Scissors, Right	92
4-0607S	4	Bishop-Harmon Suturing Forceps	68	11-0241S*	13	Castroviejo Corneal Section Scissors, Left	92
4-0600T	5	Castroviejo Suturing Forceps, 0.12 mm 1x2 Teeth	68	11-040S	13	Westcott Tenotomy Scissors	95
4-0601T*	5	Castroviejo Suturing Forceps, 0.30 mm 1x2 Teeth	68	11-044S	14	Westcott Stitch Scissors	94
4-090T	6	Kelman-McPherson Tying Forceps	69	13-110	15	Paton Double-Ended Spatula and Spoon	99
4-178S	7	McPherson Straight Tying Forceps	69	14-022S	16	Barraquer Wire Speculum, Adult Size	112
4-120S	8	Hartman Mosquito Forceps	67	15-051-25	17	Rycroft Anterior Chamber Cannula, 25 Ga	113
6-10/6-053	9	Diamond Knife, Trifacet Blade, 1.00 mm	74	15-301/303	18	Silicone Bulb with Adapter	118
6-20/6-107*	9	Diamond Knife, Trapezoid Self-Diving Blade, 2.00/2.30 mm	75	16-081S	19	Towel Forceps	70
8-031T	10	Barraquer Needle Holder, Standard Jaws, without Lock	88	16-0305*	20	Corneal Trephine Blades, 7.50 mm	123
8-045T*	10	Barraquer Needle Holder, Extra Fine Jaws, without Lock	88	16-0307	20	Corneal Trephine Blades, 8.00 mm	123
				18-305*		Plastic Sterilization Tray with Silicone Finger Mat, Double Level, Extra Large	125

*not shown

DALK SET

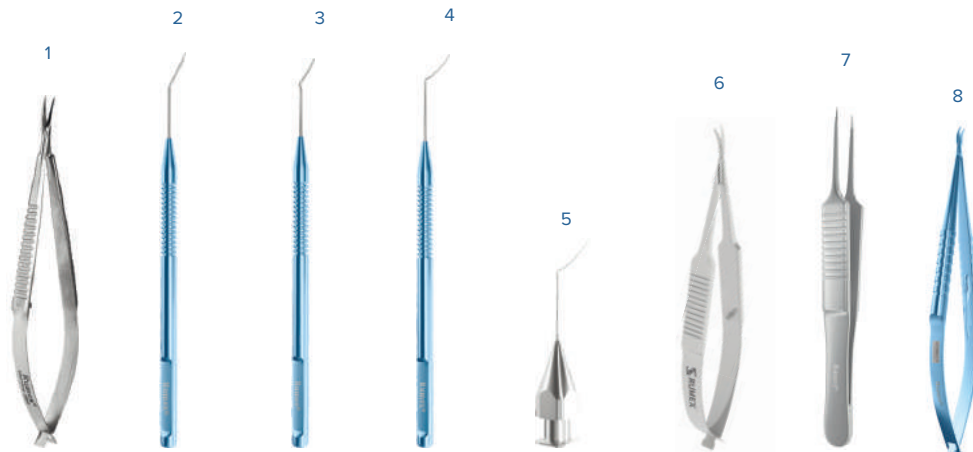

Reference	Key	Description	Page
11-038S	1	Scissors for DALK Procedure, Right	92
11-0381S*		Scissors for DALK Procedure, Left	92
13-170	2	Trisector for DALK Procedure	103
13-171	3	Spatula for DALK Procedure	103
13-172	4	Dissector for DALK Procedure	103
15-450-27	5	Cannula for DALK Procedure, 27 Ga	117

*not shown

Reference	Key	Description	Page
11-134	6	Holland Spatulated DALK Scissors, Right	93
11-135*		Holland Spatulated DALK Scissors, Left	93
4-178S	7	McPherson Tying Forceps, Straight	69
4-174T*		McPherson Tying Forceps, Angled	69
8-024T	8	Barraquer Needle Holder, Extra Fine Jaws, with Lock	88
18-305*		Plastic Sterilization Tray with Silicone Finger Mat, Double Level, Extra Large	125

DSEK, DSAEK, DMEK SET

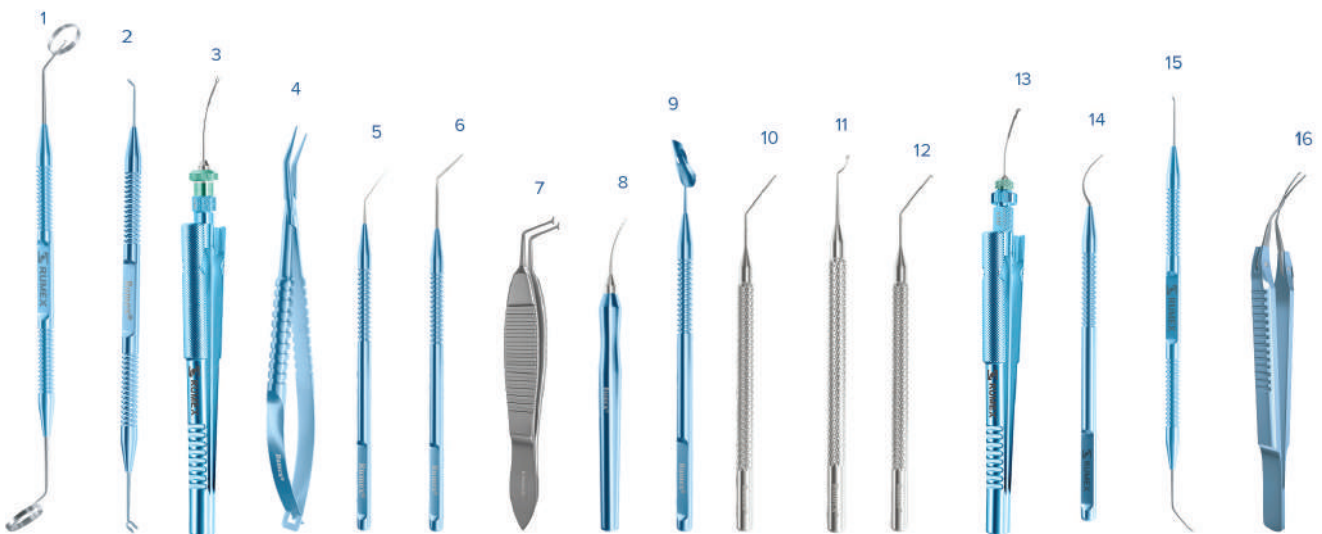

Reference	Key	Description	Page
3-0231	1	Abdullayev Corneal Marker for Keratoplasty	39
3-0230*		Abdullayev Scleral Marker for Keratoplasty	39
3-024T	2	Abdullayev I & II Marker (for DSAEK/DMEK Grafts)	40
3-208T*		DMEK/DSAEK "S" Marker	40
4-034 /12-003T	3	Forceps for Corneal Endothelium Implantation, 23 Ga/ Universal Squeeze Handle	59 / 135
4-2019T	4	Corneal Donor Insertion Forceps	59
5-0322	5	Reversed Sinskey Hook	71
13-137	6	Corneal Dissector, Straight	100
13-138*		Corneal Dissector, Curved	100
4-261S	7	Abdullayev DMEK Grasping Forceps	60
13-139/I	8	Endothelial Stripper, Irrigating	100
13-150T	9	Spatula-Guide for Corneal Endothelium Implantation	100
13-151S	10	Cindy Sweeper DSEK Spatula	101

*not shown

Reference	Key	Description	Page
13-152S	11	Carlson DSEK Smoother	101
13-153S	12	Terry DSEK Scraper	101
4-247 /12-003T	13	Florakis Microinvasive Endothelial Forceps, 23 Ga / Universal Squeeze Handle	59 / 135
4-246S*		Florakis Endothelial Forceps	59
13-182	14	John Dextatome DMEK/DSAEK Spatula	102
13-183*		John DSAEK Stromal Scrubber	102
13-184*		John DSAEK Glider	102
13-185	15	Tan Marginal DMEK Dissector	102
4-251	16	Cross-Action DMEK Forceps	60
18-305*		Plastic Sterilization Tray with Silicone Finger Mat, Double Level, Extra Large	125

Product design and/or features that do not influence its functionality and main parameters are subject to change

DLEK SET

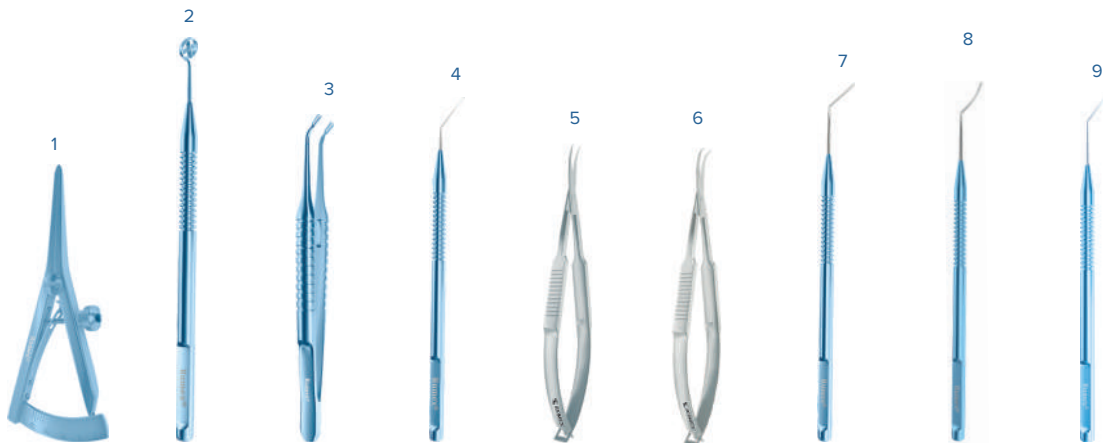

Reference	Key	Description
2-010T	1	Castroviejo Caliper
3-0217T	2	Hoffer Optical Zone Marker, 8.00 mm
4-0814T	3	Pollack Corneal Transplantation Fixation Forceps
5-0322	4	Reversed Sinsky Hook
11-036S	5	DLEK Scissors, Medium Curve

*not shown

Page	Reference	Key	Description	Page
37	11-0361S	6	DLEK Scissors, Strong Curve	93
40	13-137	7	Corneal Dissector, Straight	100
61	13-138	8	Corneal Dissector, Curved	100
71	13-160	9	Manipulator for DLEK pProcedure	103
93	18-304*		Plastic Sterilization Tray with Silicone Finger Mat, Extra Large	125

ICRS SET

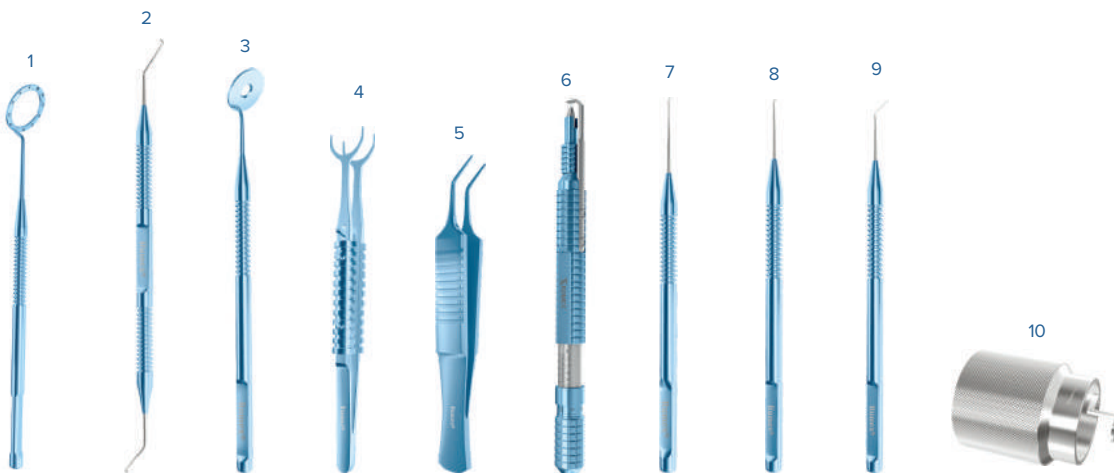

Reference	Key	Description
2-0331T	1	Grooved Mendez Degree Gauge with 4 Grooves
3-034	2	Optical Zone Marker
3-143T	3	Tunnel Zone Marker
4-08011T	4	Nevyas-Wallace Fixation Forceps
4-2144T	5	Forceps for ICRS Implant
6-00/6-020	6	Diamond Knife for ICRS, Micrometer Handle, 1.00 mm

*not shown

Reference	Key	Description	Page	
38	10-035	7	Elevator for ICRS Implantation	107
41	13-146	8	Suarez Spreader	107
41	13-147	9	Bicalto Guide	107
61	16-173S	10	Tunnel Maker, Left	123
57	16-174S*		Tunnel Maker, Right	123
74	18-304*		Plastic Sterilization Tray with Silicone Finger Mat, Extra Large	125

GLAUCOMA SET

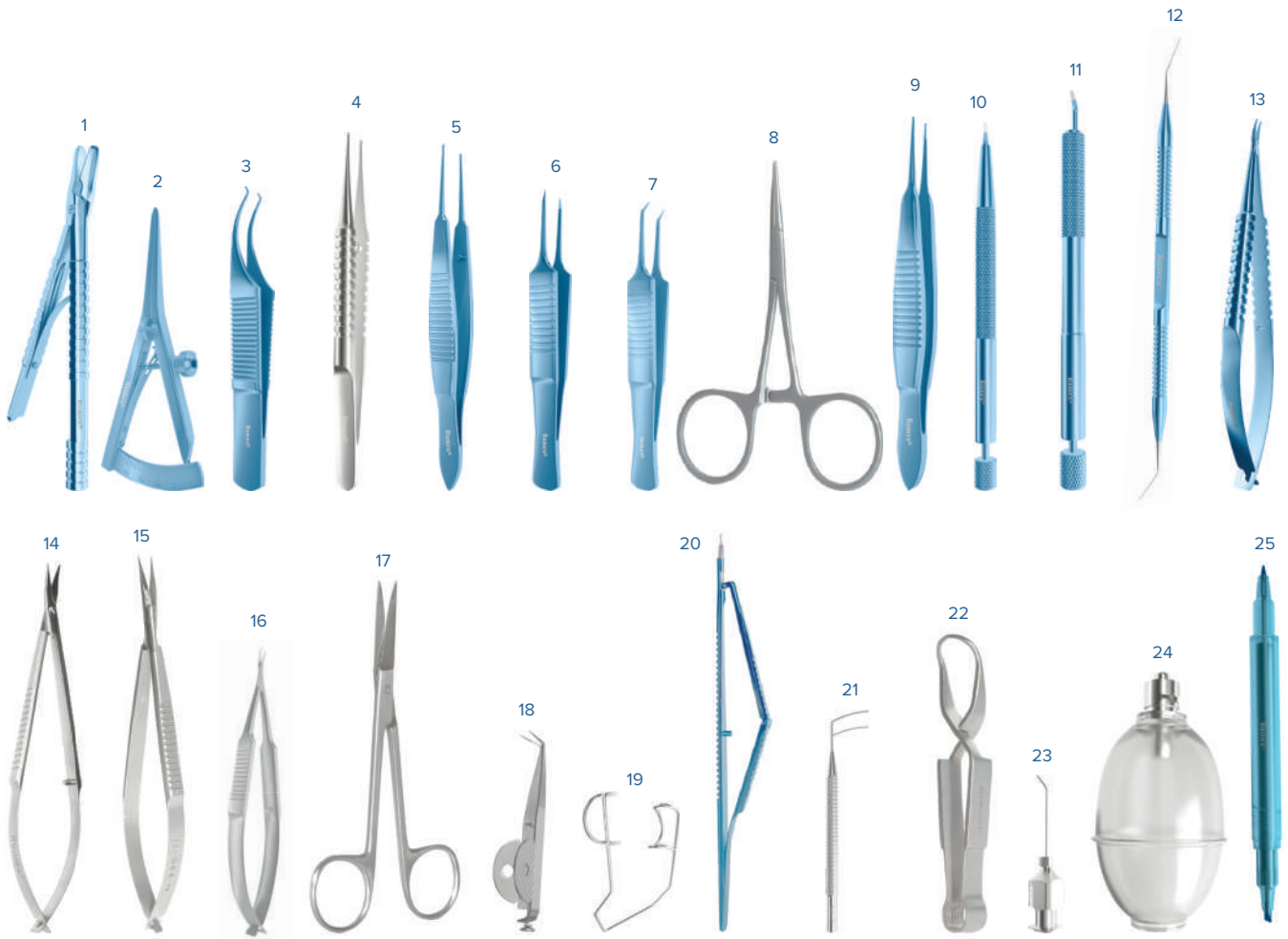

Reference	Key	Description	Page	Reference	Key	Description	Page
1-010T	1	Blade Holder	36	11-044S	15	Westcott Stitch Scissors	94
2-010T	2	Castroviejo Caliper	37	11-052S	16	Vannas Capsulotomy Scissors	96
4-050T	3	Colibri Corneal Forceps	57	11-080S	17	Iris Scissors	93
4-070S	4	Dressing Forceps with Delicate Serrations	60	11-1223	18	Barraquer Iris Scissors	94
4-0600T	5	Castroviejo Suturing Forceps	68	14-022S	19	Barraquer Wire Speculum	112
4-171T	6	McPherson Straight Tying Forceps	69	16-011	20	Kelly Descemet's Membrane Punch, 0.75 mm Diameter	122
4-090T	7	Kelman-McPherson Tying Forceps	69	16-012S	21	Harms Trabeculotome, Left	123
4-120S	8	Hartman Mosquito Forceps	67	16-013S*		Harms Trabeculotome, Right	123
4-2301T	9	Fechtner Conjunctiva Forceps	54	16-080S	22	Schaedel Towel Clamp	70
6-10/6-053	10	Diamond Knife, Trifacet Blade, 1.00 mm	74	15-051-27	23	Rycroft Anterior Chamber Cannula, 27 Ga	113
6-20/6-092	11	Diamond Knife, Crescent Blade, 2.00 mm	75	15-301/303	24	Silicone Bulb with Adapter	118
13-050	12	Castroviejo Double-Ended Cyclodialysis Spatula	98	20-050	25	Disposable Marking Pen, Double-Ended, 10 per Box	129
8-045T	13	Barraquer Needle Holder, Extra Fine Jaws, without Lock	88	18-305*		Plastic Sterilization Tray with Silicone Finger Mat, Double Level, Extra Large	125
11-040S	14	Westcott Tenotomy Scissors	95				

*not shown

PTERYGIUM SET

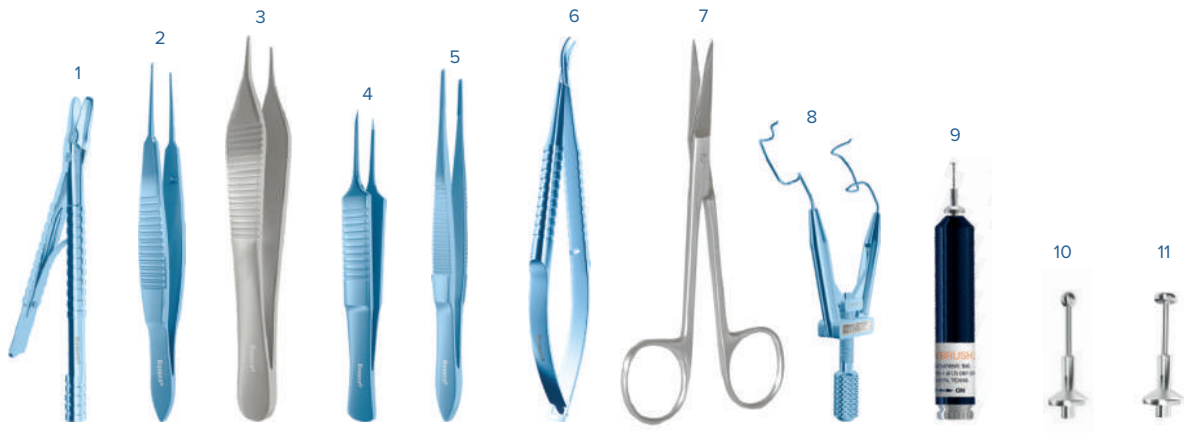

Reference	Key	Description	Page	Reference	Key	Description	Page
1-010T	1	Blade Holder	36	16-051-2.5	9	AlgerBrush with a 2.50 mm Diamond Round	119
4-0600T	2	Castroviejo Suturing Forceps	68	16-051-3.5B	10	Fine Grit Burr	119
4-0741S	3	Adson Fixation Forceps	61	16-052-5.0B	11	Diamond Round Medium Grit Burr for AlgerBrush, 3.50 mm	119
4-171T	4	McPherson Tying Forceps	69	18-304*		Diamond Disk-Shaped Medium Grit Burr for AlgerBrush, 5.00 mm	119
4-2300T	5	Bonaccolto Utility Forceps	70			Plastic Sterilization Tray with Silicone Finger Mat, Extra Large	125
8-031T	6	Barraquer Needle Holder, Standard Jaws, without Lock	88				
11-080S	7	Iris Scissors	93				
14-040T	8	Lieberman Temporal Speculum	110				

*not shown

CHALAZION SET



Reference	Key	Description	Page	Reference	Key	Description	Page
1-020S	1	Bard Parker Handle	36	16-066	5	Meyerhoefer Chalazion Curette, Size 3	122
4-1906T	2	Desmarres Chalazion Forceps, Large	54	16-067*		Meyerhoefer Chalazion Curette, Size 4	122
4-1912T*		Desmarres Chalazion Forceps, Medium	54	16-50S	6	Lid plate	121
4-1908T	3	Lambert Chalazion Forceps, Small	54	18-304*		Plastic Sterilizing Tray with Silicone Finger Mat, Extra Large	125
4-1909T	4	Lambert Chalazion Forceps, Medium	54				
16-063*		Meyerhoefer Chalazion Curette, Size 0	122				
16-064*		Meyerhoefer Chalazion Curette, Size 1	122				
16-065*		Meyerhoefer Chalazion Curette, Size 2	122				

*not shown

LACRIMAL SET



Reference	Key	Description	Page	Reference	Key	Description	Page
1-010T	1	Blade Holder	36	10-013	12	Stevenson Lacrimal Sac Retractor	90
4-071S	2	Dressing Forceps	60	10-014	13	Knapp Lacrimal Sac Retractor	90
4-2300T	3	Bonaccolto Utility Forceps	70	11-080S	14	Iris Scissors	93
4-0601T	4	Castroviejo Suturing Forceps	68	11-125S	15	Westcott Type Stitch Scissors	94
4-122S	5	Halsted Mosquito Forceps	67	11-130S	16	Stevens Scissors	95
8-031T	6	Barraquer Needle Holder, Standard Jaws, without Lock	88	15-029	17	Lacrimal Cannula, Reinforced, Curved, 23 Ga	118
9-010S	7	Bowman Lacrimal Probe, Size 0000-000	89	15-301/303	18	Silicone Bulb with Adapter	118
9-011S*		Bowman Lacrimal Probe, Size 00-0	89	16-081S	19	Towel Forceps	70
9-012S*		Bowman Lacrimal Probe, Size 1-2	89	16-127	20	Nasal speculum, Adult Size	123
9-013S*		Bowman Lacrimal Probe, Size 3-4	89	16-135	21	Surgical Mallet, Polished Finish	123
9-014S*		Bowman Lacrimal Probe, Size 5-6	89	16-136	22	Kerrison Ronger, Size 0	121
9-021S	8	Quickert Lacrimal Intubation Probe, Size 0	89	16-138	23	Belz Lacrimal Sac Rongeur	121
9-031	9	Pigtail Lacrimal Probe	89	21-R7011	24	Disposable DCR Set, Straight 4.50 cm	27
9-050T	10	Wilder Lacrimal Dilator, Size 1	89	18-305*		Plastic Sterilization Tray with Silicone Finger Mat, Double Level, Extra Large	125
9-060T	11	Castroviejo Double-Ended Lacrimal Dilator, Size 1 & 2	89				

*not shown

LID SET

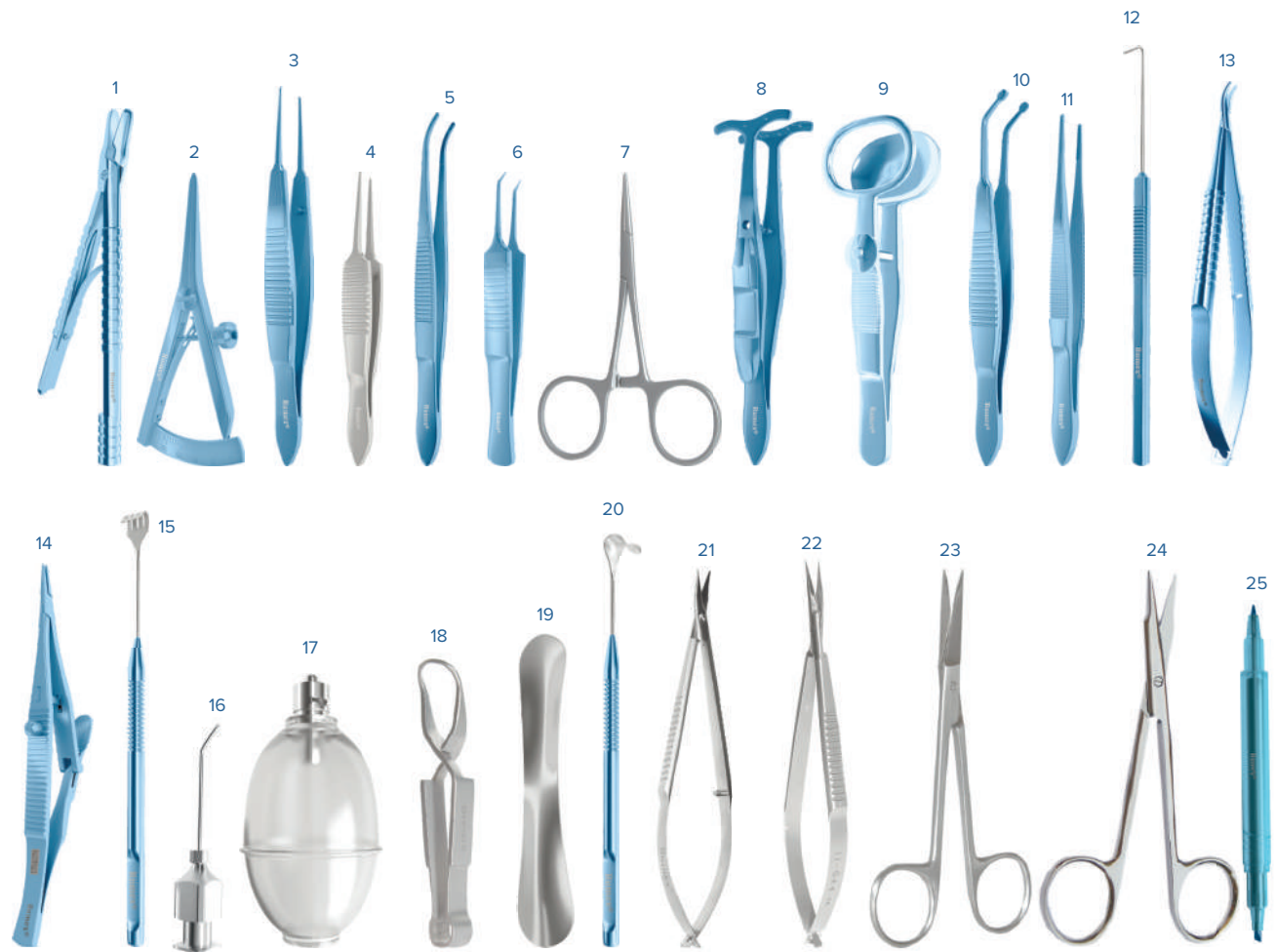

Reference	Key	Description	Page	Reference	Key	Description	Page
1-010T	1	Blade Holder	36	10-014	15	Knapp Lacrimal Sac Retractor	90
2-010T	2	Castroviejo Caliper	37	15-055-19	16	Bishop Harmon AC Cannula, 19 Ga	113
4-0601T	3	Castroviejo Suturing Forceps	68	15-301/303	17	Silicone Bulb with Adapter	118
4-0607S	4	Bishop-Harmon Suturing Forceps	68	16-080S	18	Schaedel Towel Clamp	70
4-072T	5	Dressing Forceps	60	16-50S	19	Lid Plate	121
4-090T	6	Kelman-McPherson Tying Forceps	69	10-020*		Desmarres Lid Retractor, Size 0	90
4-120S	7	Hartman Mosquito Forceps	67	10-021	20	Desmarres Lid Retractor, Size 1	90
4-140T	8	Putterman Type Lid Clamp	54	10-022*		Desmarres Lid Retractor, Size 2	90
4-1906T	9	Desmarres Chalazion Forceps, Large	54	10-023*		Desmarres Lid Retractor, Size 3	90
4-1912T*		Desmarres Chalazion Forceps, Medium	54	11-040S	21	Westcott Tenotomy Scissors	95
4-124S*		Compressing Lid Forceps with Atraumatic Rollers	55	11-044S	22	Westcott Stitch Scissors	94
4-1913T	10	Compressing Lid Forceps	55	11-080S	23	Straight Iris Scissors	93
4-2300T	11	Bonaccolto Utility Forceps	70	11-133S	24	Stevens Tenotomy Scissors	95
5-042	12	Graefe Muscle Hook, Size 2	72	20-050	25	Disposable Marking Pen, Double-Ended, 10 per Box	129
8-031T	13	Barraquer Needle Holder, Standard Jaws, without Lock	88	18-305*		Plastic Sterilization Tray with Silicone Finger Mat, Double Level, Extra Large	125
8-080T	14	Kalt Needle Holder	87				

*not shown

MUSCLE SET

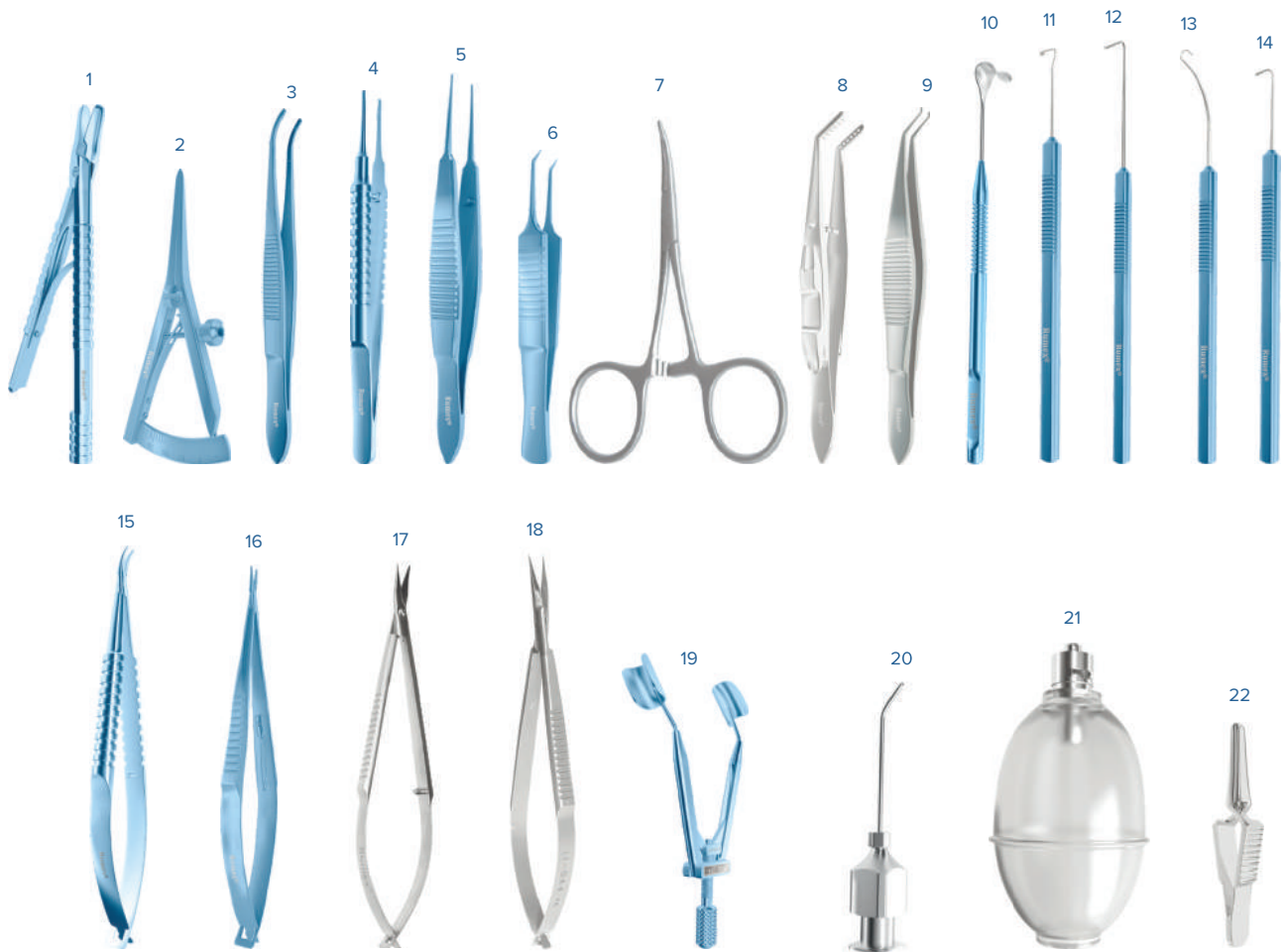

Reference	Key	Description	Page	Reference	Key	Description	Page
1-020S	1	Bard Parker Handle	36	5-061	13	Scobee Oblique Muscle Hook	73
2-010T	2	Castroviejo Caliper	37	5-062	14	Stevens Curved Tenotomy Hook	73
4-072T	3	Dressing Forceps	60	8-090T	15	Barraquer Needle Holder, Strong Jaws, with Lock	88
4-0551T	4	Corneal Forceps, Bonn-Catalano Type	58	8-0921T	16	Castroviejo Needle Holder, Delicate Jaws, with Lock	87
4-0602T	5	Castroviejo Suturing Forceps	68	11-040S	17	Westcott Tenotomy Scissors	95
4-090T	6	Kelman-McPherson Tying Forceps	69	11-044S	18	Westcott Stitch Scissors	94
4-121S	7	Hartman Mosquito Forceps	67	14-0601T	19	Kershner Reversible Solid Blade Speculum	109
4-130S	8	Jameson Muscle Forceps, Left	67	15-055-19	20	Bishop Harmon AC Cannula, 19 Ga	113
4-131S*		Jameson Muscle Forceps, Right	67	15-301/303	21	Silicone Bulb with Adapter	118
4-136S	9	Osher Superior Rectus Forceps	68	16-090S	22	Serrefine	67
10-022	10	Desmarres Lid Retractor, Size 2	90	18-305*		Plastic Sterilization Tray with Silicone Finger Mat, Double Level, Extra Large	125
5-040	11	Jameson Muscle Hook	72				
5-042	12	Graefe Muscle Hook, Size 2	72				

*not shown

OCULOPLASTIC SET

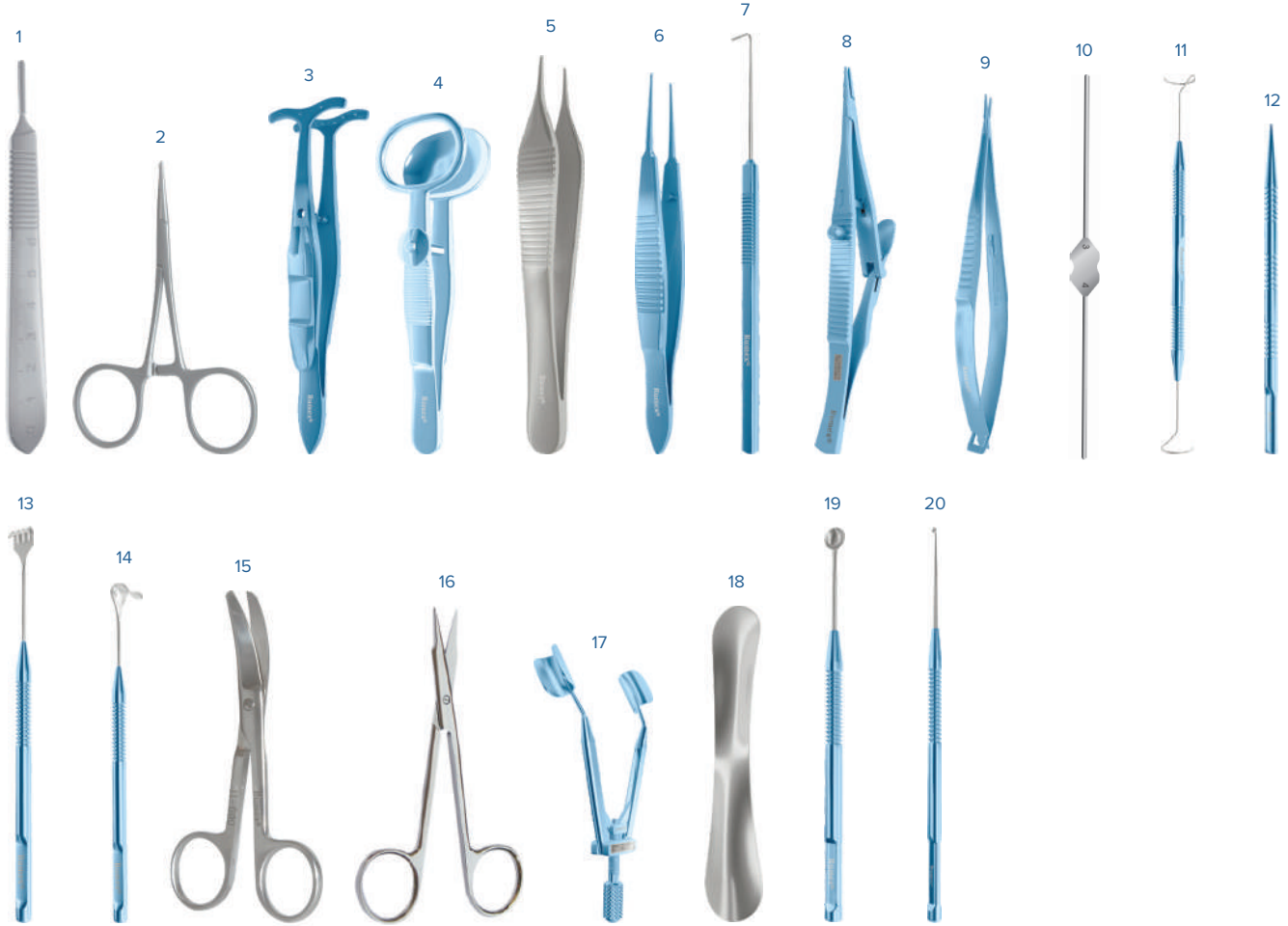

Reference	Key	Description	Page	Reference	Key	Description	Page
1-020S	1	Bard Parker Handle	36	9-050T	12	Wilder Lacrimal Dilator, Size 1	89
4-120S	2	Hartman Mosquito Forceps	67	10-014	13	Knapp Lacrimal Sac Retractor	90
4-140T	3	Putterman Type Lid Clamp	54	10-022	14	Desmarres Lid Retractor, Size 2	90
4-1906T	4	Desmarres Chalazion Forceps, Large	54	11-090S	15	Enucleation Scissors	97
4-0741S	5	Adson Fixation Forceps	61	11-133S	16	Stevens Tenotomy Scissors	95
4-0822T	6	Castroviejo Fixation Forceps	61	14-0601T	17	Kershner Reversible Solid Blade Speculum	109
5-042	7	Graefe Muscle Hook, Size 2	72	16-50S	18	Lid Plate	121
8-080T	8	Kalt Needle Holder	87	16-061	19	Bunge Evisceration Spoon, Small	122
8-0921T	9	Castroviejo Needle Holder, Delicate Jaws, with Lock	87	16-066	20	Meyerhoefer Chalazion Curette, Size 3	122
9-012S	10	Bowman Lacrimal Probe, Size 1-2	89	18-305*		Plastic Sterilization Tray with Silicone Finger Mat, Double Level, Extra Large	125
9-031	11	Pigtail Lacrimal Probe	89				

*not shown

ENUCLEATION / EVISCERATION SET

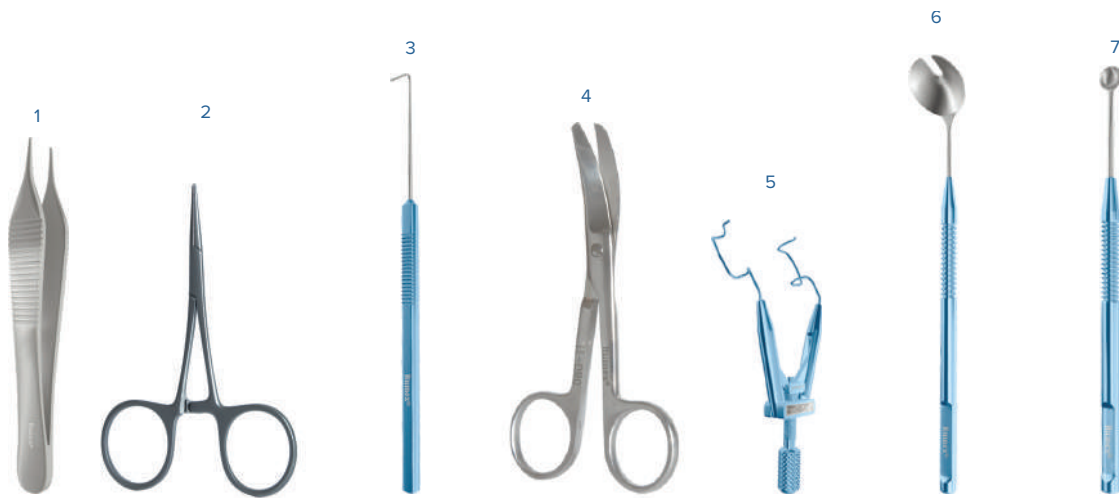

Reference	Key	Description
4-0741S	1	Adson Fixation Forceps
4-120S	2	Hartman Mosquito Forceps
5-042	3	Graefe Muscle Hook, Size 2
11-090S	4	Enucleation Scissors
11-101S*		Knapp Strabismus Scissors

Page	Reference	Key	Description	Page
61	14-040T	5	Lieberman Temporal Speculum	110
67	16-060	6	Wells Enucleation Spoon	123
72	16-061	7	Bunge Evisceration Spoon	122
97	18-304*		Plastic Sterilization Tray with Silicone Finger Mat, Extra Large	125
94				

*not shown

DON'T FORGET TO BUY

Complete any set with a sterilization tray. RUMEX offers a variety of plastic and aluminum trays of different sizes and configurations.



Plastic Trays

RUMEX plastic trays are molded from General Electric's ULTEM® resin, using mold flow analysis to guarantee product strength, structural integrity, and extended life cycle.

Aluminum Trays

RUMEX aluminum trays are manufactured from an anodized aluminum alloy to prevent corrosion, ensure fast drying and long-term use. Lightweight* for easy transportation and handling.

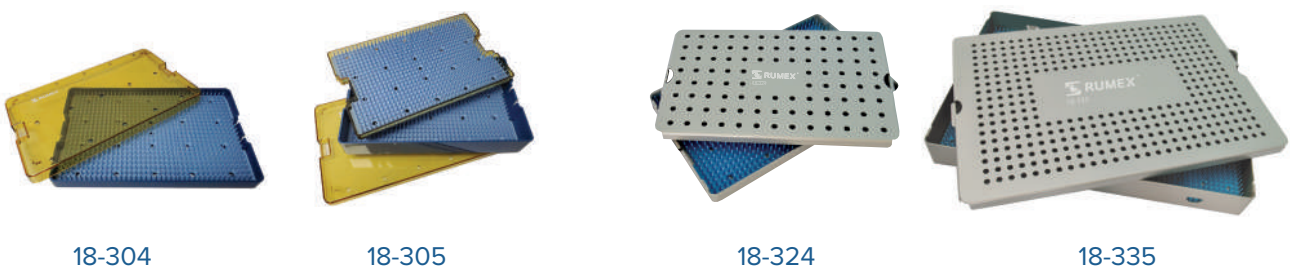

Item	Dimensions, (L×W×H)		Configuration	Accommodates, number of instruments	
	mm	in			
Plastic Trays					
1	18-304	254×152×19 mm	10×6×0.75"	Single level	10-15
2	18-305	254×152×38 mm	10×6×1.5"	Double level	20-30
Aluminum Trays					
3	18-324	260×160×20 mm	10.25×6.25×0.80"	Single level	10-15
4	18-335	390×265×40 mm	15.5×10.5×1.5"	Single level	25-35

Other trays are available in RUMEX range

*Compared to Stainless Steel Trays

Product design and/or features that do not influence its functionality and main parameters are subject to change

REUSABLE SET, 20 GA

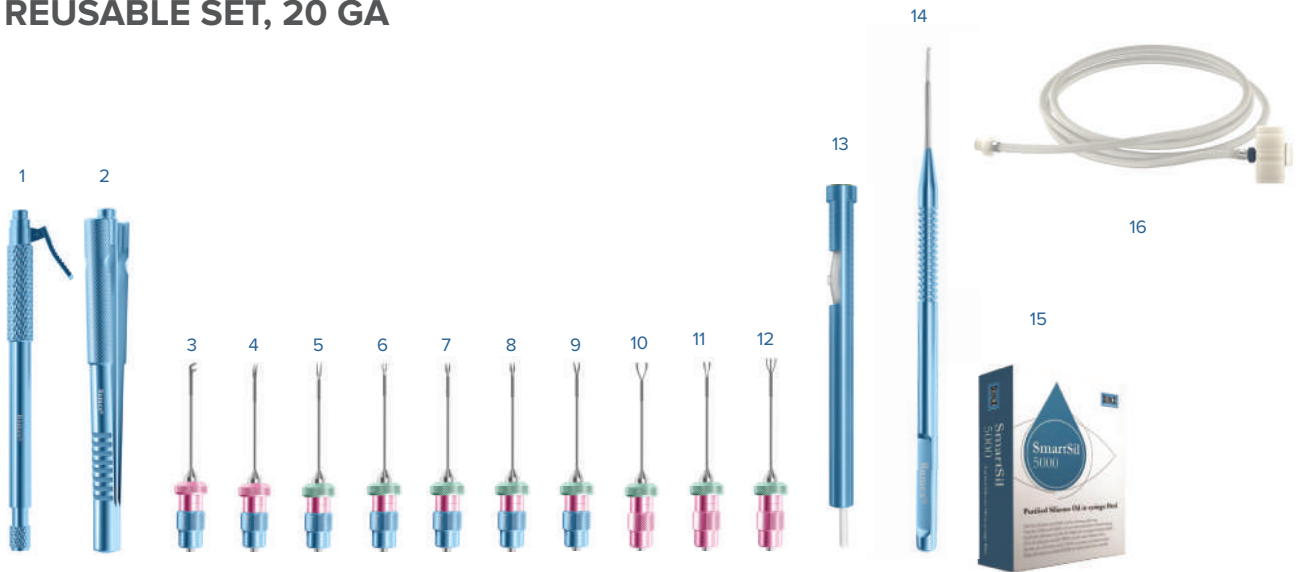

Reference	Key	Description	Page
12-001T	1	Universal Instrument Handle, One Finger Control	135
12-003T	2	Universal Instrument Handle, Squeeze Model, Two Fingers Control	135
12-202	3	Vertical Vitreoretinal Scissors, 20 Ga, Tip only	136
12-209	4	Curved Subretinal Scissors, 20 Ga, Tip only	136
12-410	5	Eckardt End-Gripping Forceps, 20 Ga, Tip only	137
12-411	6	Tano Asymmetrical End-Gripping Forceps, 20 Ga, Tip only	137
12-301	7	Vitreoretinal Forceps with a Sandblasted Platform, 20 Ga, Tip only	138
12-304	8	Gripping Forceps with a "Crocodile" Platform, 20 Ga, Tip only	138
12-325	9	Pick Vitreoretinal Forceps, 20 Ga, Tip only	139
12-335	10	Stolyarenko Forceps for Large Foreign Bodies, 20 Ga, Tip only	139
12-313	11	Vitreoretinal Forceps with Cup Jaws, 20 Ga, Tip only	139
12-321	12	Spring Gripping Forceps, 20 Ga, Tip only	139
12-6000	13	Titanium Backflush Handle, Active Aspiration	148
13-092	14	Membrane Scratcher, 20 Ga	140
SmartSil5000	15	Purified Silicone Oil for Retinal Endotamponade, 5000 cSt	150
12-RTUB-2	16	Reusable Tubing System for the Infusion of Silicone Oil	150
18-305*		Plastic Sterilization Tray with Silicone Finger Mat, Double Level, Extra Large	125

*not shown

REUSABLE SET, 23 GA

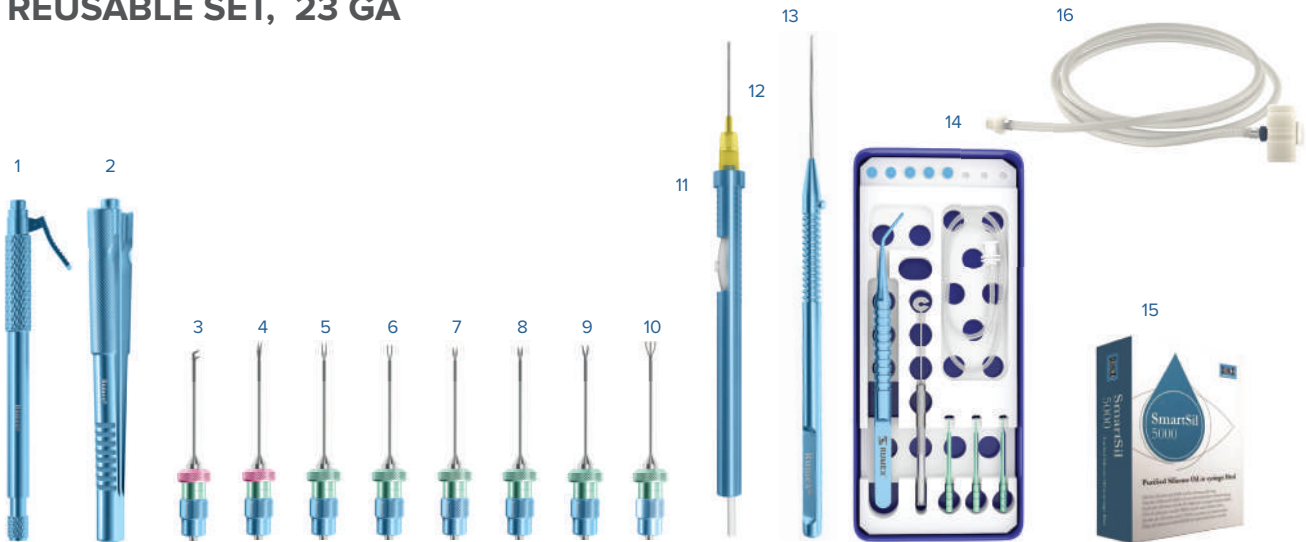

Reference	Key	Description	Page	Reference	Key	Description	Page
12-001T	1	Universal Instrument Handle, One Finger Control	135	12-325-23	9	Pick Vitreoretinal Forceps, 23 Ga, Tip only	139
12-003T	2	Universal Instrument Handle, Squeeze Model, Two Fingers Control	135	12-321-23	10	Spring Gripping Forceps, 23 Ga, Tip only	139
12-202-23	3	Vertical Vitreoretinal Scissors, 23 Ga, Tip only	136	12-6000	11	Titanium Backflush Handle, Active Aspiration	148
12-209-23	4	Curved Subretinal Scissors, 23 Ga, Tip only	136	12-5161	12	Soft Tip Cannula, 23 Ga, Disposable, 5 per Box	149
12-410-23	5	Eckardt End-Gripping Forceps, 23 Ga, Tip only	137	13-097-23	13	Delicate Membrane Pick, 23 Ga	140
12-4013	6	End-Grasping Forceps, Expanded Space between Branches, 23 Ga, Tip only	137	12-5173-23	14	Reusable Trocar System, 23 Ga	144
12-301-23	7	Vitreoretinal Forceps with a Sandblasted Platform, 23 Ga, Tip only	138	SmartSil5000	15	Purified Silicone Oil for Retinal Endotamponade, 5000 cSt	150
12-304-23	8	Vitreoretinal Forceps with a "Crocodile" Platform, 23 Ga, Tip only	138	12-RTUB-2	16	Reusable Tubing System for the Infusion of Silicone Oil	151
				18-305*		Plastic Sterilization Tray with Silicone Finger Mat, Double Level, Extra Large	125

*not shown

DISPOSABLE SET, 23 GA



Reference	Key	Description	Page	Reference	Key	Description	Page
12-5229	1	Disposable One Step Trocar System 23 Ga, 6 per Box	147	12-304-23DP	6	Disposable Vitreoretinal Gripping Forceps with a "Crocodile Platform", 23 Ga, Plastic Handle 360°, 6 per Box	146
12-5161H	2	Backflush Instrument with Soft Tip, 23 Ga, 6 per Box	148	12-202-23DP	7	Disposable Vitreoretinal Vertical Scissors, 23 Ga, Plastic Handle 360°, 6 per Box	146
12-7523	3	Disposable Diamond Dusted Retractable ILM Elevator, 23 Ga, 5 per Box	146	12-5203	8	Dual Bore PFC Cannula, 23 Ga, 5 per Box	149
12-209-23DP	4	Disposable Vitreoretinal Curved Scissors, 23 Ga, Plastic Handle 360°, 6 per Box	146	12-5248	9	Viscous Fluid Injection Cannula, 23 Ga, 4 mm Tip, 5 per Box	151
12-410-23DP	5	Disposable Vitreoretinal Eckardt End-Gripping Forceps, 23 Ga, Plastic Handle 360°, 6 per Box	146	SmartSil5000	10	Purified Silicone Oil for Retinal Endotamponade, 5000 cSt	150

Product design and/or features that do not influence its functionality and main parameters are subject to change

REUSABLE SET, 25 GA

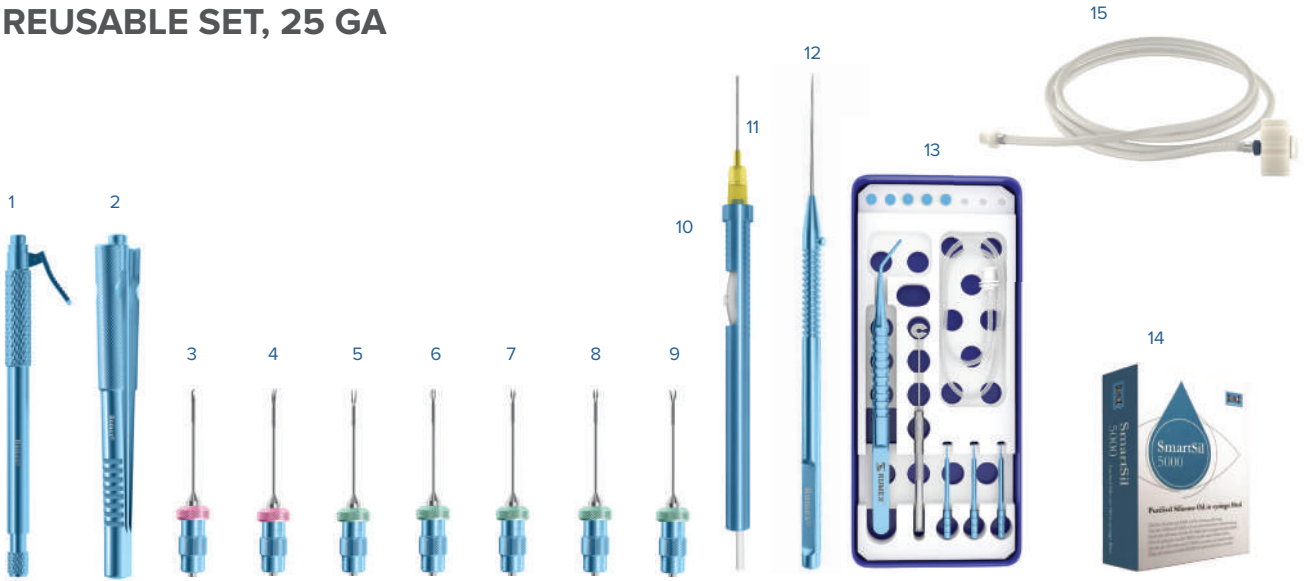

Reference	Key	Description	Page	Reference	Key	Description	Page
12-001T	1	Universal Instrument Handle, One Finger Control	135	12-3259	9	Pick Vitreoretinal Forceps, 25 Ga, Tip only	142
12-003T	2	Universal Instrument Handle, Squeeze Model, Two Fingers Control	135	12-6000	10	Titanium Backflush Handle, Active Aspiration	148
12-2029	3	Vertical Vitreoretinal Scissors, 25 Ga, Tip only	142	12-5152	11	Soft Tip Cannula, 25 Ga, Disposable, 5 per Box	149
12-2099	4	Curved Subretinal Scissors, 25 Ga, Tip only	142	13-0979	12	Delicate Membrane Pick, 25 Ga	140
12-410-25	5	Eckardt End-Gripping Forceps, 25 Ga, Tip only	142	12-5173-25	13	Reusable Trocar System, 25 Ga	144
12-420-25	6	Asymmetrical End-Grasping Forceps, 25 Ga, Tip Only	142	SmartSil5000	14	Purified Silicone Oil for Retinal Endotamponade, 5000 cSt	150
12-3019	7	Vitreoretinal Forceps with a Sandblasted Platform, 25 Ga, Tip only	142	12-RTUB-2	15	Reusable Tubing System for the Infusion of Silicone Oil	151
12-304-25	8	Vitreoretinal Forceps with a "Crocodile" Platform, 25 Ga, Tip only	142	18-305*		Plastic Sterilization Tray with Silicone Finger Mat, Double Level, Extra Large	125

*not shown

DISPOSABLE SET, 25 GA

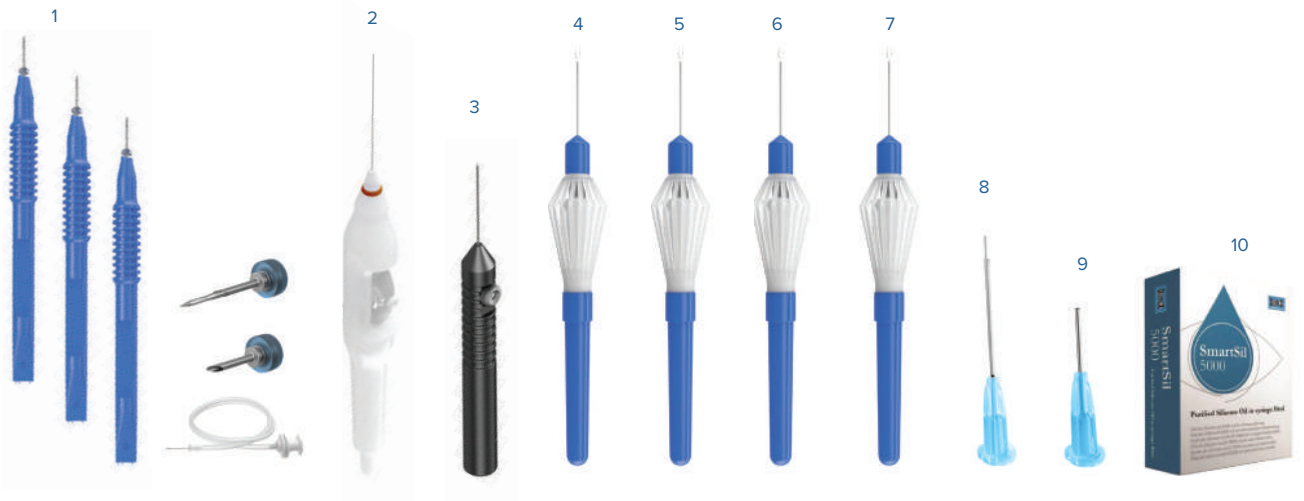

Reference	Key	Description	Page	Reference	Key	Description	Page
12-5244	1	Disposable One Step Trocar System 25 Ga, 6 per Box	147	12-304-25DP	6	Disposable Vitreoretinal Gripping Forceps with a "Crocodile Platform", 25 Ga, Plastic Handle 360°, 6 per Box	146
12-5152H	2	Backflush Instrument with Soft Tip, 25 Ga, 6 per Box	148	12-202-25DP	7	Disposable Vitreoretinal Vertical Scissors, 25 Ga, Plastic Handle 360°, 6 per Box	146
12-7525	3	Disposable Diamond Dusted Retractable ILM Elevator, 25 Ga, 5 per Box	146	12-5205	8	Dual Bore PFC Cannula, 25 Ga, 5 per Box	149
12-209-25DP	4	Disposable Vitreoretinal Curved Scissors, 25 Ga, Plastic Handle 360°, 6 per Box	146	12-5258	9	Viscous Fluid Injection Cannula, 25 Ga, 4 mm Tip, 5 per Box	151
12-410-25DP	5	Disposable Vitreoretinal Eckardt End-Gripping Forceps, 25 Ga, Plastic Handle 360°, 6 per Box	146	SmartSil5000	10	Purified Silicone Oil for Retinal Endotamponade, 5000 cSt	150

Product design and/or features that do not influence its functionality and main parameters are subject to change

APPENDIXES

STERILIZATION AND CARE	176
General Instructions for Care,Cleaning and Sterilization	176
Handling of Diamond Knives	182
Handling of Vitreoretinal and Microincisional Instruments	186
ABBREVIATIONS	190
INDEX	191
CERTIFICATES	212

STERILIZATION AND CARE

GENERAL INSTRUCTIONS FOR CARE, CLEANING AND STERILIZATION

We at RUMEX guarantee our instruments against manufacturing defects, but the lifespan of reusable instruments lies within proper handling and care. To help your instruments preserve their initial conditions, we strongly recommend you to read the instructions below carefully before use.

A common misconception that “stainless steel” or “titanium” have extreme durability and are indestructible is in need of correction: these metals still might be affected by chemical, mechanical, thermal attacks and etc. However, if you are aware of metal characteristics and understand how to handle them, the lifespan of the instruments may be enlarged.

A particular care should be taken after microsurgical instruments as they have very delicate working tips. These instructions are general recommendations, cleaning guidelines of the solutions, equipment manufacturer and your institution, especially those regarding temperature, time of exposure and concentration, should be observed.

INSPECTION

It is essential that the instrument is inspected before use. Please conduct this inspection under a microscope or magnification lens. If a problem is detected, notify us immediately. Once the instrument is examined and accepted, IT SHOULD BE CLEANED BEFORE PLACING IT IN THE STERILIZATION TRAY.

Stage 1: DESINFECTION

Never skip this cleaning stage as residues on instruments such as care agents and the ones of package materials may form stains and depositions in course of sterilization.

It is imperative to follow the rules:

1. As much moisture as possible must be eliminated from all instrument's parts since moisture promotes corrosion.
2. Only detergents and cleaners specially designed for use on surgical stainless steel or titanium instruments are acceptable for use in all the cleaning process. Cleaning guidelines of the solution manufacturer and your institution should be observed.
3. Thorough cleaning immediately after use is essential for the longevity of the instrument. We recommend that the established surgical instrument cleaning procedures of your institution be followed using these instructions as a guideline.
4. The cleaning/disinfecting solutions should be exchanged daily.

STEPS OF MANUAL CLEANING IN SOLUTION

1. For effective cleaning of instruments it is recommended to start pre-treatment as soon as possible, no later than 30 minutes after surgery is completed. The cleaning/disinfection should be carried out within the next two hours.
2. Use distilled/demineralized water to prepare the working solution. Use chemicals with non-protein-fixing process and with/without anti-microbial effects. Prepare the solution according to the manufacturer's instructions. Water layer above the instruments should be no less than 1 cm (.39 inches). Water temperature should be as specified in the manufacturer's instructions.
3. Instruments with hinges and joints must be handled open. The detachable products should be disassembled prior to be immersed into the solution. Products with locks should be immersed open with preliminary several working movements done inside the solution for its better penetration into hard-to-reach areas of the instruments. Make sure that there are no air bubbles in the cavities and all the inner surfaces are affected.
4. Carry out disinfection according to the mode, indicated in the instructions of product manufacturer. **We recommend soaking instruments in a detergent with pH level between 6-9 for 10 min at 40 °C/104 °F.** Make sure the disinfectant is free of aldehydes, glutaraldehydes. The solution should not foam. Stainless steel tools must not be exposed for a long time to media which can promote corrosion (for example, chloride or iodine ions). This also applies to the vapors of the substances mentioned.

WARNING! Do not immerse stainless steel instruments in an isotonic solution (e.g. physiological saline solution) as stress corrosion cracking and pitting may occur.

5. Wash each product with a brush or a cotton-gauze sponge. Use a syringe to wash the lumens of the instruments. Remove all macroscopically visible dirt.

WARNING! Never use abrasive powders or steel wool to remove stubborn stains – these can damage the superfine finish of an instrument and can actually help cause corrosion of stainless instruments.

6. Place the products in a container with distilled/demineralized water and wash off the remaining solution with thorough rinsing of all lumens for 5 minutes. Repeat the procedure if necessary.
7. Then rinse with distilled water to prevent spotting. Instruments with lumens should be flushed out at least five times at the beginning and at the end of the cleaning (10 ml/0.34 fl.oz distilled or deionized water to be used each time).
8. Dry instruments carefully before sterilization with a hot air blower or lint-free cloth. Compressed air is preferred. Sterile compressed air should be used to insufflate cavities of the instruments.
9. The cleaning results must be visually inspected. The instruments must be visibly clean.

Stage 2: CLEANING

MANUAL CLEANING PROCESS

ULTRASONIC CLEANING

As some instruments may become heavily soiled during the surgery, the additional cleaning in the ultrasonic bath will be required.

The following rules should be followed:

1. Place the instruments on a silicone mat inside the ultrasonic bath.
2. Fill the bath with room temperature water. **The temperature higher than 45 °C (113 °F) can lead to encrustation due to denaturation of the protein.**
3. Use detergent to soak the instruments. A distilled/demineralized water should be used to prepare the working solution. Make it according to the manufacturer's instructions. Newly prepared cleaning solutions require degassing prior to the first use.
4. Place instruments next to each other without stacking them.
5. When carrying out ultrasonic cleaning, all parameters specified by the manufacturer of the cleaning agent, such as exposure time and concentration, must be observed. Cleaning agents must be compatible with instruments.
6. The use of ultrasonic baths and strong cleaning fluids (alkaline pH > 9 or acid pH < 5) can shorten the lifespan of the products. Make sure the appropriate agents are chosen for performing the procedure.
7. When using deionized water or cleaning solution fully submerge the instruments. Change the ultrasonic solution from ultrasound cleaner after each use.

Instruments with hinges and joints must be handled open to minimize the obscured surface areas. The detachable products should be disassembled prior to be immersed into the solution.

Products with locks should be immersed open with preliminary several working movements done inside the solution for its better penetration into hard-to-reach areas of the instruments.

WARNING! Special care should be taken to make certain that the instrument does not come into contact with any metal surface of the ultrasonic container, as this could damage the instrument.

8. Carry out the cleaning procedure. Turn on ultrasonic bath. 3 minutes exposure at frequencies of around 35 kHz would be sufficient. Use soft bristled nylon brush to clean all the parts of the instrument, inside and outside.
9. Place the products in a container with distilled/demineralized water and wash off the remaining solution with thorough rinsing of all lumens for 5 minutes. Repeat the procedure if necessary.
10. Then rinse with distilled water to avoid water spots.
11. Dry the instruments before sterilization. A lint free cloth may be used for manual drying. Sterile compressed air should be used to insufflate cavities of the instruments.

WARNING! DO NOT apply ultrasonic cleaning to diamond knives or instruments with delicate tips (e.g. vitreoretinal and microincisional tips, choppers, hooks, manipulators and etc.)

MANUAL DISINFECTION:

1. Submerge the instruments in the cleaning solution.
2. Make sure to follow the exposure times and concentration of disinfectants and not to combine non-compatible ones.
3. After use of cleaning agent, rinse the instruments with distilled/demineralized water at least 5 times and flush the lumens to remove the disinfectant.
4. Repeat if there are still visible impurities on the surface of the instruments.

Manual drying may be done by use of lint free towel or using sterile compressed air to insufflate lumens of the instruments.

AUTOMATED CLEANING PROCESS

1. Baskets in the form of nets with large holes are recommended to be used in special washing equipment. Be sure to use tool holders in the basket. Place instruments inside them without overloading.
2. Make sure that the large instruments don't obscure other ones and don't create spray shadows.
3. Sort tools by similar metals, avoiding contact between dissimilar ones. This type of contact can cause galvanic corrosion.
4. Use a solution suitable for washing equipment with low foaming property.
5. Use a neutralizer, which not only neutralizes alkali, but also reduces surface tension of the liquid during drying, accelerating it, and minimizing stains.
6. Set the program for the cleaning step. The chosen program must be suitable for the products and include the appropriate number of rinsing cycles.

For automated cleaning and disinfection thermal and chemo-thermal disinfection options are available. During **thermal processes** disinfection is carried out at temperatures above 65 °C (149°F). A reprocessing program may include the following steps:

1. Pre-wash with cold water to remove dirt and foaming substances.
2. Cleaning is performed with use of suitable pH-neutral or alkaline products added to hot or cold distilled water at temperatures of 40-60 °C (104-140 °F) for at least 5 minutes.
3. Intermediate rinse in hot or cold distilled water with acidic neutralizer added in order to facilitate the removal of remaining alkaline disinfectants.
4. Second intermediate rinse in hot or cold distilled water without additives should follow.
5. Thermal disinfection and final rinse is performed at temperatures of 80-95 °C (176-203 °F).
6. Drying might be carried out in washer/disinfector or in other possible ways. Sterile compressed air should be used to insufflate cavities of the instruments.

Chemo-thermal disinfection is suitable for heat-sensitive products. The temperature is limited in all rinsing stages and during the step of drying.

Cleaning is performed normally at < 65 °C (149 °F). A reprocessing program may include the following steps:

1. Pre-wash with cold water to remove dirt and foaming substances.
2. Cleaning is performed with use of suitable pH-neutral or alkaline products added to hot or cold distilled water at temperatures of 40-60 °C (104-140 °F) for at least 5 minutes.
3. Intermediate rinse in hot or cold distilled water followed by chemo-thermal disinfection. Special cleaning agent, compatible with machine-disinfection, is used.
4. Intermediate rinse in hot or cold distilled water without additives.
5. Final rinsing with distilled water at higher temperature.
6. Drying might be carried out in washer/disinfector or in other possible ways. Sterile compressed air should be used to insufflate cavities of the instruments.

- **The cleaning device must be regularly maintained, checked and validated in accordance with internal and manufacturer requirements.**
- **When processing the ophthalmic instruments we recommend using the additional intermediate rinsing with water in the washing programs before the final rinse.**
- **Additional rinsing outside the washing equipment is not required.**

A combination of processing stages 1 and 2 is allowed.

WARNING! Tools with blind holes, long narrow tips (e.g. tips, cannulas, handpieces and etc), hinges (3-joint instruments) need more attention during cleaning process. The temperature at all stages of the process should not exceed 170 °C (338 °F).

Distilled/deionized water is recommended for all the reprocessing cycles as tap water may cause an increase in ions concentrations on the surface of Stainless Steel instruments.

Aspiration speculums and cannulas with tubes (e.g. Simcoe) require additional cleaning of silicone tubes prior to be sterilized.

First, soak the instrument in the soap solution at temperature of 50 °C (122 °F) and keep it there for 15 min. After that wash the instrument with brush and cotton/gauze pad. Take the instrument out of soap bath and wash it under streaming water for 3 min. Rinse the instrument with distilled or deionized water. Then attach a syringe filled with warm water into the luer lock and rinse the silicone tubes of the instrument. Finally, blow them with air by forcing one or two syringes full of air through the tubes.

RECOMMENDED PRODUCTS FOR CARE AND CLEANING

Product name, Manufacturer	Description	Composition	Compatibility
SEKUSEPT Activ , Ecolab Deutschland GmbH	Disinfectant for automatic and manual processing of tools	≥ 30% oxygen-based bleaching agents; <5% non-ionic surfactants, phosphonates; 50% sodium perborate monohydrate; 25% tetraacetylenediamine; active antimicrobial components, nonionic surfactants, corrosion inhibitor; pH of 2% solution: 7.4-8.4	Compatible. Discoloration of metal, residual detergent or water film formation may occur.
Neodisher MediClean Forte , Dr. Weigert GmbH & Co.	Detergent for automatic and manual cleaning of surgical instruments. Prevents reprecipitation of protein residues.	< 5% non-ionic and anionic surfactants; enzymes; pH: 10.4-10.8	Compatible. Discoloration of metal, residual detergent or water film formation may occur.
Neodisher MediKlar , Dr. Weigert GmbH & Co.	Rinser for automatic and manual cleaning of surgical instruments. Recommended for use with MediClean forte. Prevents reprecipitation of protein residues.	< 5% anionic surfactants, polycarboxylates; 5 - 15% non-ionic surfactants also preservatives; 2-octyl-2H-isothiazol-3-one, a mixture of: 5-Chloro-2-methyl-2H-isothiazol-3-one [EC-no.247-500-7] and 2-Methyl-2H-isothiazol-3-one; pH: 5.9-6.9	Compatible
ERIZYME , KiiltoClean FARMOS Oy	Detergent for hand treatment, washer disinfectors and ultrasonic treatment	non-ionic surfactants (< 5%); amphoteric surfactants (< 5%); complexing agent (5-15%); monopropylene glycol (15-30%); anti-foaming agent; enzymes; pH: 7.5	Compatible
ERISAN OXY+ , KiiltoClean FARMOS Oy	Disinfectant in disposable sachets	sodium percarbonate 30 - <50%; citric acid 15 - <30%; tartaric acid 5 - <15%; pH: 5.9-6.9	Compatible. Discoloration of metal, residual detergent or water film formation may occur.

Fully demineralized water for rinsing and correct loading must be used to prevent staining!

WARNING! Hydrogen peroxide H₂O₂ may discolor titanium instruments.

The color of titanium instruments may change due to development of different properties of oxide layers. Such discoloration does not bring a safety risk, as well as water stains on the surface of the instruments. They don't affect the biocompatibility, functionality, and lifetime of the instruments. However, discoloration may affect the visual inspection of the tools (e.g. determining residual dirt). To prevent the color change of titanium instruments, use only neutral or mild alkaline cleaning agents. While using them, do not exceed a temperature of 70 °C (158 °F).

LUBRICATION

Moving parts and working mechanisms of the Rumex instruments should be lubricated occasionally with a medical grade instrument lubricant (especially after an ultrasonic bath) to ensure the smooth operation of the working mechanism. The lubricant must be biocompatible, suitable for steam sterilization and vapor-permeable. No silicone oil should be applied. The paraffin/white oil based lubricants are allowed to be used.

The following products are recommended - Neodisher IP Spray, Miltex-Integra Spray Lube Instrument Lubricant, Sterilit® i lubricant.

After cleaning process let the instruments cool down to room temperature prior to their actuation, as otherwise metal abrasion may develop when the details of the tools rub against each other. This may destroy the instruments' functionality.

The recommended directions of the instrument lubricant manufacturer and your institution should be observed.

Stage 3: STERILIZATION

Surgical instruments should be stored at room temperature in dry rooms in the sterilizing trays of proper size and lined with soft silicone mats. Instruments should not touch each other. We recommend using protective tips made of soft silicone tubing of the proper size and thickness. Do not use rubber or plastic protective tips, as they can melt during autoclaving and cause damage of instruments.

WARNING! Never store the instruments close to the chemicals.

Stainless steel and titanium instruments can be sterilized via steam autoclaving, chemical disinfectants, ethylene oxide gas, or even dry hot air. Gas and dry chemical sterilization are the best methods for stainless steel instruments, but it takes a lengthy time period to accomplish the desired result. The most practical method of sterilization is heat or steam, which require less time, however, these methods can be damaging to delicate instruments. Please, be sure that you and the members of your staff have read and understood the instructions supplied by the manufacturer of your particular sterilizer.

STERILIZATION CYCLES

Finally, the instrument should be sterilized prior to the next surgical procedure.

WARNING! Only clean, disinfected, and dry products can be sterilized.

For lumen instruments (e.g. tips, cannulas, handpieces) the gravity procedure is not suitable!

RUMEX instruments can be sterilized using any of the following methods:

100% ETO cycles	
Concentration ETO	850±50mg/l
Temperature	37-47°C (99-117°F)
Exposure time	3–4 hours
Humidity	70% RH minimum
Drying Cycle	1 hour

WARNING! ETO method is not recommended for diamond knives sterilization.

Sterilizer Type	Steam Autoclaving		“Flash” Autoclaving	
	Gravity Displacement	Prevacuum	Gravity Displacement	Prevacuum
Sample Config.	wrapped	wrapped	unwrapped	unwrapped
Temperature°C	+132°C	+132°C	+132°C	+132°C
Temperature°F	+270°F	+270°F	+270°F	+270°F
Exposure Time	34 minutes	3 minutes	10 minutes	3 minutes
Drying Cycle	min. 10 minutes	min. 10 minutes	min. 10 minutes	min. 10 minutes

**WARNING! Sterilization steam must not contain any impurities.
Autoclave drying cycle should be used to avoid oxidation.**

Gas plasma sterilization is not recommended as delicate instruments might be physically damaged when exposed to low pressure.

The above-mentioned sterilization cycles represent the industry standards and should be capable of producing a sterile device. Due to variations in sterilization equipment and device bioburden in clinical use, RUMEX International Co. is not able to provide specific cycle parameters. It is the responsibility of each user to perform the validation and verification of the sterilization cycle to ensure an adequate sterility assurance level for our products.

WARNING! Follow the guidelines of the processing times. The rapid sterilization process should be reserved for emergency processing only and should not be used for routine instrument sterilization. Longer sterilization period and higher temperatures can lead to premature aging of instruments.

AT THE END OF THE SURGICAL DAY

Instruments should be washed clean of all residues, dried and inspected after each use. Be sure to inspect every microsurgical instrument at the end of your surgical day. Please conduct this inspection under a microscope or magnification lens. If a damaged instrument is detected, repair or replace it. Washing, drying and inspecting the instrument under magnification helps to ensure that the instrument is kept in proper condition for the next surgical procedure.

HANDLING OF DIAMOND KNIVES

We at RUMEX guarantee our instruments against manufacturing defects, but the lifespan of reusable instruments lies within proper handling and care. To help your instruments preserve their initial conditions, we strongly recommend you to read the instructions below carefully before use.

These instructions are being general recommendations, cleaning guidelines of the solutions, equipment manufacturer, and your institution, especially those regarding temperature, time of exposure and concentration, should be observed.

APPLICATION

Ophthalmic microsurgical knives with diamond blades are used for cutting and dissection of tissues during ophthalmic, microvascular, neurosurgical, and plastic surgery.

CHARACTERISTICS

The blades are made of natural diamonds and the handles are manufactured from titanium alloy. The thickness of the diamond blade cutting edge should not exceed 0.2 μm . The blade points must be edged with no visible chips (visible at 100x power magnification). The diamond knife consists of a titanium handle and a diamond blade. The handle is fit with a mechanism providing blade installation and its safe fixation in an operative and non-operative position. The construction of the knife can be changed in order to improve its usability.

USAGE INSTRUCTIONS

1. The diamond blade is very fragile, therefore, each knife must be handled, cleaned, and stored delicately. Avoid blows or vibrations. Any contact of the blade with other instruments or materials should be avoided.
2. Before using a knife, make sure there are no chips on the cutting edge. A microscope with at least 100x power magnification should be used for the inspection.
3. When transporting diamond knives, the blades must be fully retracted into the handles (non-operative position). We recommend the knives to be kept and carried in sterilizing cases or with a PTFE shipping clamp to avoid self-movement. When a knife is not in use, its blade must be retracted into the handle and protected from mechanical damage.
4. Please rotate the movable part of the handle clockwise and fix the blade to set the knife in its operative position. The blade is to be set in the operative position for the surgical operation just prior to usage.
5. After usage, slightly pull the movable part of the handle downwards and rotate counterclockwise to return the blade into its non-operative position. To avoid accidental movements of the spring, please make sure the handle is fixed tightly. When a handle is fixed, a slight click will occur.
6. To install the knife with a micrometer, pull the protective cap down and rotate the bottom part of the handle (with a scale) downwards; the blade will appear. Customize the depth of the blade by screwing the handle; the scale marks will indicate the chosen depth. The scale increment is 0.005 mm. Rotate the handle upwards then put on the protective cap to set the knife in the initial non-operative position.

The service life of the knife varies due to usage and handling. The blade must never be dropped or be in contact with foreign objects. The blade and the spring mechanism need to be handled with care and caution.

Never disassemble the parts of the knife.

INSPECTION

It is essential that the instrument is inspected before use. Please conduct this inspection under a microscope or magnification lens. If a problem is detected, notify us immediately. Once the instrument is examined and accepted, IT SHOULD BE CLEANED BEFORE PLACING IT IN THE STERILIZATION TRAY.

Incoming inspection is obligatory. It includes:

1. Visual examination of the package obtained: no mechanical damages are permitted.
2. Visual inspection of the knife: no mechanical damages such as cracks, chips, oxide scales etc. are permitted; all parts of the knife must be joined smoothly.
3. Blade must be set into the operating/non-operating position without jamming; it must be fixed easily.

Please examine the blade before each operation and never use a knife in the event any defect is noticed. Damaged knives should be sent for sharpening or blade replacement.

Stage 1: DESINFECTION

Soaking

1. For effective cleaning of instruments it is recommended to start pre-treatment as soon as possible, no later than 30 minutes after surgery is completed. The cleaning/disinfection should be carried out within the next two hours.
2. Use distilled/demineralized water to prepare the working solution.
3. Water temperature should be as specified in the manufacturer's instructions. Water layer above the instruments should be no less than 1 cm (.39 inches).
4. Make sure the disinfectant is free of aldehydes, glutaraldehydes.
5. Carry out disinfection according to the mode, indicated in the instructions of product manufacturer. Disinfectant solution should not foam.

Rinsing

1. Place the products in a container with distilled/demineralized water and wash off the remaining solution.
2. Then rinse with distilled water.

Stage 2: PRE-STERILIZATION CLEANING

Never skip this cleaning stage as residues on instruments such as care agents and the ones of package materials may form stains and depositions in course of sterilization.

It is imperative to follow the rules:

1. As much moisture as possible must be eliminated from all instrument's parts since moisture promotes corrosion.
2. Only detergents and cleaners specially designed for use on surgical stainless steel or titanium instruments are acceptable for use in all the cleaning process. Cleaning guidelines of the solution manufacturer and your institution should be observed.
3. Thorough cleaning immediately after use is essential for the longevity of the instrument. We recommend that the established surgical instrument cleaning procedures of your institution be followed using these instructions as a guideline.
4. The cleaning/disinfecting solutions should be exchanged daily.

WARNING! Never use abrasive powders or steel wool to remove stubborn stains – these can damage the superfine finish of an instrument and can actually help cause corrosion of stainless instruments.

CLEANING OF DIAMOND KNIVES

1. Use a syringe with distilled or demineralized water to flush the instrument.
2. Dip the knife (blade retracted) into weak alkaline cleaning solution and keep for 60 minutes at a temperature of 22°C (72°F).
3. The handle of a knife can be cleaned with a soft brush.
4. Flush the instrument with flowing water for 30 seconds, then sluice with distilled water for other 30 seconds; the blade should be pointed down for flushing.

WARNING! DO NOT apply ultrasonic cleaning to diamond knives.



We recommend to use a Diamond Knife Cleaning Pack (21-602-1) for gentle cleaning of the blade. The pack contains three solutions that eliminate residual debris off the blade and prepare it for sterilization.

Diamond knives can be cleaned in an automatic washer designed for micro-surgical instruments. Please follow the manufacturer's instruction.

Make sure the blade is in its non-operative position (retracted) before sterilization; self-movement must be avoided. We recommend sterilizing the knives in trays specially designed for diamond knives as the silicone holders will help stabilize them.

RECOMMENDED PRODUCTS FOR CARE AND CLEANING

Product name, Manufacturer	Description	Composition	Compatibility
SEKUSEPT Activ, Ecolab Deutschland GmbH	Disinfectant for automatic and manual processing of tools	≥ 30% oxygen-based bleaching agents; <5% non-ionic surfactants, phosphonates; 50% sodium perborate monohydrate; 25% tetraacetylenediamine; active antimicrobial components, nonionic surfactants, corrosion inhibitor; pH of 2% solution: 7.4-8.4	Compatible. Discoloration of metal, residual detergent or water film formation may occur.
Neodisher MediClean Forte, Dr. Weigert GmbH & Co.	Detergent for automatic and manual cleaning of surgical instruments. Prevents reprecipitation of protein residues.	< 5% non-ionic and anionic surfactants; enzymes; pH: 10.4-10.8	Compatible. Discoloration of metal, residual detergent or water film formation may occur.
Neodisher MediKlar, Dr. Weigert GmbH & Co.	Rinser for automatic and manual cleaning of surgical instruments. Recommended for use with MediClean forte. Prevents reprecipitation of protein residues.	< 5% anionic surfactants, polycarboxylates; 5 - 15% non-ionic surfactants also preservatives; 2-octyl-2H-isothiazol-3-one, a mixture of: 5-Chloro-2-methyl-2h-isothiazol-3-one [EC-no.247-500-7] and 2-Methyl-2H-isothiazol-3-one; pH: 5.9-6.9	Compatible
ERIZYME, KiioltoClean FARMOS Oy	Detergent for hand treatment, washer disinfectors and ultrasonic treatment	non-ionic surfactants (< 5%); amphoteric surfactants (< 5%); complexing agent (5-15%); monopropylene glycol (15-30%); anti-foaming agent; enzymes; pH: 7.5	Compatible
ERISAN OXY+, KiioltoClean FARMOS Oy	Disinfectant in disposable sachets	sodium percarbonate 30 - <50%; citric acid 15 - <30%; tartaric acid 5 - <15%; pH: 5.9-6.9	Compatible. Discoloration of metal, residual detergent or water film formation may occur.

Fully demineralized water for rinsing and correct loading must be used to prevent staining!

WARNING! Hydrogen peroxide H₂O₂ may discolor titanium instruments.

The color of titanium instruments may change due to development of different properties of oxide layers. Such discoloration does not bring a safety risk, as well as water stains on the surface of the instruments. They don't affect the biocompatibility, functionality, and lifetime of the instruments. However, discoloration may affect the visual inspection of the tools (e.g. determining residual dirt). To prevent the color change of titanium instruments, use only neutral or mild alkaline cleaning agents. While using them, do not exceed a temperature of 70°C (158°F).

LUBRICATION

Moving parts and working mechanisms of the Rumex instruments should be lubricated occasionally with a medical grade instrument lubricant to ensure the smooth operation of the working mechanism. The lubricant must be biocompatible, suitable for steam sterilization and vapor-permeable. No silicone oil should be applied. The paraffin/white oil based lubricants are allowed to be used.

The following products are recommended - Neodisher IP Spray, Miltex-Integra Spray Lube Instrument Lubricant, Sterilit® i lubricant.

After cleaning process let the instruments cool down to room temperature prior to their actuation, as otherwise metal abrasion may develop when the details of the tools rub against each other. This may destroy the instruments' functionality.

The recommended directions of the instrument lubricant manufacturer and your institution should be observed.

Stage 3: STERILIZATION

Diamond knives can be sterilized via steam autoclaving, chemical disinfectants, ethylene oxide gas, or even dry hot air. The most practical method of sterilization is heat or steam, which require less time, however, these methods can be damaging to delicate instruments. Please, be sure that you and the members of your staff have read and understood the instructions supplied by the manufacturer of your particular sterilizer.

STERILIZATION CYCLES

Finally, the instrument should be sterilized prior to the next surgical procedure.

WARNING! Only clean and disinfected products can be sterilized.

	Steam Autoclaving		"Flash" Autoclaving	
	Gravity Displacement	Prevacuum	Gravity Displacement	Prevacuum
Sterilizer Type	Gravity Displacement	Prevacuum	Gravity Displacement	Prevacuum
Sample Config.	wrapped	wrapped	unwrapped	unwrapped
Temperature°C	+132°C	+132°C	+132°C	+132°C
Temperature°F	+270°F	+270°F	+270°F	+270°F
Exposure Time	34 minutes	3 minutes	10 minutes	3 minutes
Drying Cycle	min. 10 minutes	min. 10 minutes	min. 10 minutes	min. 10 minutes

WARNING! Sterilization steam must not contain any impurities.

Knife must not be treated at more than 140°C (284°F).

Autoclave drying cycle should be used to avoid oxidation.

Gas plasma sterilization is not recommended as delicate instruments might be physically damaged when exposed to low pressure.

The above-mentioned sterilization cycles represent the industry standards and should be capable of producing a sterile device. Due to variations in sterilization equipment and device bioburden in clinical use, RUMEX International Co. is not able to provide specific cycle parameters. It is the responsibility of each user to perform the validation and verification of the sterilization cycle to ensure an adequate sterility assurance level for our products.

WARNING! Follow the guidelines of the processing times. The rapid sterilization process should be reserved for emergency processing only and should not be used for routine instrument sterilization. Longer sterilization period and higher temperatures can lead to premature aging of instruments.

AT THE END OF THE SURGICAL DAY

Instruments should be washed clean of all residues, dried and inspected after each use. Be sure to inspect every microsurgical instrument at the end of your surgical day. Please conduct this inspection under a microscope or magnification lens. If a damaged instrument is detected, repair or replace it. Washing, drying and inspecting the instrument under magnification helps to ensure that the instrument is kept in proper condition for the next surgical procedure.

STORAGE

Diamond knives must be kept at a temperature from 10 to 25°C (50 to 77°F) and relative air humidity at max. 75% at 25°C (77°F). Indoor air must not contain corrosive additive agents. The blade must be fully retracted into the handle (non-operative position). Self-movement must be avoided and blows or vibrations should be avoided.

WARNING! Never store the instruments close to the chemicals.

MANUFACTURER'S WARRANTY

Manufacturer guarantees knives to be in accordance with the documentation when service and storage instructions are followed by the consumer. We provide a 2 year guarantee for the spring mechanism and titanium parts. The diamond blade can be resharpened or exchanged according to the after-sale service program.

HANDLING OF VITREORETINAL AND MICROINCISIONAL INSTRUMENTS

We at RUMEX guarantee our instruments against manufacturing defects, but the lifespan of reusable instruments lies within proper handling and care. To help your instruments preserve their initial conditions, we strongly recommend you to read the instructions below carefully before use.

A common misconception that “stainless steel” or “titanium” have extreme durability and are indestructible is in need of correction: these metals still might be affected by chemical, mechanical, thermal attacks and etc. However, if you are aware of metal characteristics and understand how to handle them, the lifespan of the instruments may be enlarged.

A particular care should be taken after microsurgical instruments as they have very delicate working tips. These instructions are being general recommendations, cleaning guidelines of the solutions, equipment manufacturer and your institution, especially those regarding temperature, time of exposure and concentration, should be observed.

APPLICATION

RUMEX Instruments (ophthalmic scissors and forceps for vitreoretinal and microincisional surgery) are designed for various applications in ophthalmic surgery. It is essential that the instrument is cleaned and sterilized before initial use and after each surgery, following as outlined in this instruction brochure.

CARE AND HANDLING

The intraocular tips have a delicate precision mechanism inside. Intraocular fluids will enter this mechanism during surgery. Proteins may also accumulate inside of the mechanism. If these fluids are not promptly and properly cleaned out, it will lead to corrosion or clogs and the possibility of instrument malfunction. Ensure the cleaning procedure is implemented after each surgery — warranty shall not extend to instruments that have been improperly handled. One-piece and two-piece vitreoretinal instruments are cleaned by use of special adapter and cannula.

INSPECTION

It is essential that the instrument is inspected before use. Please conduct this inspection under a microscope or magnification lens. If a problem is detected, notify us immediately. Once the instrument is examined and accepted, IT SHOULD BE CLEANED BEFORE PLACING IT IN THE STERILIZATION TRAY.

Stage 1: PRE-STERILIZATION CLEANING

Never skip this cleaning stage as residues on instruments such as care agents and the ones of package materials may form stains and depositions in course of sterilization.

It is imperative to follow the rules:

1. As much moisture as possible must be eliminated from all instrument's parts since moisture promotes corrosion.
2. Only detergents and cleaners specially designed for use on surgical stainless steel or titanium instruments are acceptable for use in all the cleaning process. Cleaning guidelines of the solution manufacturer and your institution should be observed.
3. Thorough cleaning immediately after use is essential for the longevity of the instrument. We recommend that the established surgical instrument cleaning procedures of your institution be followed using these instructions as a guideline.
4. The cleaning/disinfecting solutions should be exchanged daily.

WARNING! Never use abrasive powders or steel wool to remove stubborn stains – these can damage the superfine finish of an instrument and can actually help cause corrosion of stainless instruments.

CLEANING OF TWO-PIECE VITREORETINAL INSTRUMENTS



1. Unscrew the tip from the handle, then attach flushing adapter 12-000T.
2. Flush the tip with distilled or demineralized water by connecting a syringe filled with water to adapter.
3. Flush the tip with alcohol - this will remove the water and facilitate drying.
4. Dry the tip by forcing one or two syringes full of air through tip. Pressurized air is recommended, as it flushes out debris and fluid more efficiently than syringe forced air. Thoroughly dry handle, tip and cup.
5. Handle should be soaked in distilled or demineralized water for two minutes.
6. Dry with surgical sponge.
7. Lubricate joints in handle with instrument milk and work the mechanism by pressing the key.

CLEANING OF ONE-PIECE VITREORETINAL INSTRUMENTS

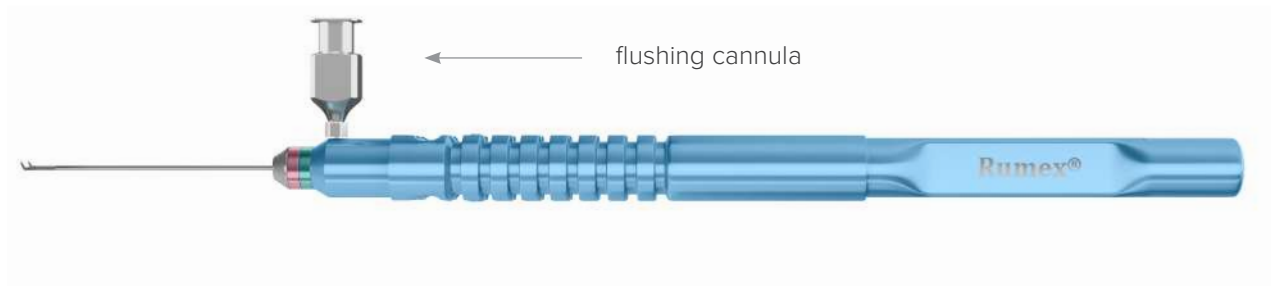

1. Put the instrument into PTFE protector (provided).
2. Soak it in the soap solution at temperature of 50°C (122°F) and keep it there for 15 min.
3. Wash the handle with brush and cotton/gauze pad.
4. Take the instrument out of soap bath and wash it under streaming water for 3 min.
5. Rinse the instrument with distilled or demineralized water.
6. After that flush the instrument with alcohol solution. It will remove water and contribute to drying.
7. Next, adjust the cannula on the luer of the syringe and fill the syringe with distilled or demineralized water.
8. A tube of the cannula then should be inserted into the port, situated at the base of the barrel near the colored wheels.
9. Flush the tube of the instrument and the tip with distilled or demineralized water by forcing syringe plunger. Then repeat the procedure with use of alcohol solution.
10. Finally, blow the air inside the tube by forcing it from the syringe into the port of the instrument. Pressurized air is recommended, as it flushes out debris and fluid more efficiently than syringe forced air.

WARNING! DO NOT apply ultrasonic cleaning to vitreoretinal and microincisional tips.

RECOMMENDED PRODUCTS FOR CARE AND CLEANING

Product name, Manufacturer	Description	Composition	Compatibility
SEKUSEPT Activ, Ecolab Deutschland GmbH	Disinfectant for automatic and manual processing of tools	≥ 30% oxygen-based bleaching agents; <5% non-ionic surfactants, phosphonates; 50% sodium perborate monohydrate; 25% tetraacetylenediamine; active antimicrobial components, nonionic surfactants, corrosion inhibitor; pH of 2% solution: 7.4-8.4	Compatible. Discoloration of metal, residual detergent or water film formation may occur.
Neodisher MediClean Forte, Dr. Weigert GmbH & Co.	Detergent for automatic and manual cleaning of surgical instruments. Prevents reprecipitation of protein residues.	< 5% non-ionic and anionic surfactants; enzymes; pH: 10.4-10.8	Compatible. Discoloration of metal, residual detergent or water film formation may occur.

Product name, Manufacturer	Description	Composition	Compatibility
Neodisher MediKlar, Dr. Weigert GmbH & Co.	Rinser for automatic and manual cleaning of surgical instruments. Recommended for use with MediClean forte. Prevents reprecipitation of protein residues.	< 5% anionic surfactants, polycarboxylates; 5 - 15% non-ionic surfactants also preservatives; 2-octyl-2H-isothiazol-3-one, a mixture of: 5-Chloro-2-methyl-2h-isothiazol-3-one [EC-no.247-500-7] and 2-Methyl-2H-isothiazol-3-one; pH: 5.9-6.9	Compatible
ERIZYME, KiiltoClean FARMOS Oy	Detergent for hand treatment, washer disinfectors and ultrasonic treatment	non-ionic surfactants (< 5%); amphoteric surfactants (< 5%); complexing agent (5-15%); monopropylene glycol (15-30%); anti-foaming agent; enzymes; pH: 7.5	Compatible
ERISAN OXY+, KiiltoClean FARMOS Oy	Disinfectant in disposable sachets	sodium percarbonate 30 - <50%; citric acid 15 - <30%; tartaric acid 5 - <15%; pH: 5.9-6.9	Compatible. Discoloration of metal, residual detergent or water film formation may occur.

Fully demineralized water for rinsing and correct loading must be used to prevent staining!

WARNING! Hydrogen peroxide H₂O₂ may discolor titanium instruments.

The color of titanium instruments may change due to development of different properties of oxide layers. Such discoloration does not bring a safety risk, as well as water stains on the surface of the instruments. They don't affect the biocompatibility, functionality, and lifetime of the instruments. However, discoloration may affect the visual inspection of the tools (e.g. determining residual dirt). To prevent the color change of titanium instruments, use only neutral or mild alkaline cleaning agents. While using them, do not exceed a temperature of 70 °C (158 °F).

LUBRICATION

Moving parts and working mechanisms of the Rumex instruments should be lubricated occasionally with a medical grade instrument lubricant (especially after an ultrasonic bath) to ensure the smooth operation of the working mechanism. The lubricant must be biocompatible, suitable for steam sterilization and vapor-permeable. No silicone oil should be applied. The paraffin/white oil based lubricants are allowed to be used.

The following products are recommended - Neodisher IP Spray, Miltex-Integra Spray Lube Instrument Lubricant, Sterilit® i lubricant.

After cleaning process let the instruments cool down to room temperature prior to their actuation, as otherwise metal abrasion may develop when the details of the tools rub against each other. This may destroy the instruments' functionality.

The recommended directions of the instrument lubricant manufacturer and your institution should be observed.

Stage 3: STERILIZATION

Stainless steel and titanium instruments can be sterilized via steam autoclaving, chemical disinfectants, ethylene oxide gas, or even dry hot air. Gas and dry chemical sterilization are the best methods for stainless steel instruments, but it takes a lengthy time period to accomplish the desired result. The most practical method of sterilization is heat or steam, which require less time, however, these methods can be damaging to delicate instruments. Please, be sure that you and the members of your staff have read and understood the instructions supplied by the manufacturer of your particular sterilizer.

STERILIZATION CYCLES

Finally, the instrument should be sterilized prior to the next surgical procedure.

WARNING! Only clean and disinfected products can be sterilized.

For lumen instruments (e.g. tips, cannulas) the gravity procedure is not suitable!

RUMEX instruments can be sterilized using any of the following methods:

100% ETO cycles	
Concentration ETO	850±50mg/l
Temperature	37-47°C (99-117°F)
Exposure time	3–4 hours
Humidity	70% RH minimum
Drying Cycle	1 hour

	Steam Autoclaving	“Flash” Autoclaving
Sterilizer Type	Prevacuum	Prevacuum
Sample Config.	wrapped	unwrapped
Temperature°C	+132°C	+132°C
Temperature°F	+270°F	+270°F
Exposure Time	3 minutes	3 minutes
Drying Cycle	min. 10 minutes	min. 10 minutes

WARNING! Sterilization steam must not contain any impurities.
Autoclave drying cycle should be used to avoid oxidation.

Gas plasma sterilization is not recommended as delicate instruments might be physically damaged when exposed to low pressure.

The above-mentioned sterilization cycles represent the industry standards and should be capable of producing a sterile device. Due to variations in sterilization equipment and device bioburden in clinical use, RUMEX International Co. is not able to provide specific cycle parameters. It is the responsibility of each user to perform the validation and verification of the sterilization cycle to ensure an adequate sterility assurance level for our products.

WARNING! Follow the guidelines of the processing times. The rapid sterilization process should be reserved for emergency processing only and should not be used for routine instrument sterilization. Longer sterilization period and higher temperatures can lead to premature aging of instruments.

AT THE END OF THE SURGICAL DAY

Instruments should be washed clean of all residues, dried and inspected after each use. Be sure to inspect every microsurgical instrument at the end of your surgical day. Please conduct this inspection under a microscope or magnification lens. If a damaged instrument is detected, repair or replace it. Washing, drying and inspecting the instrument under magnification helps to ensure that the instrument is kept in proper condition for the next surgical procedure.

STORAGE

Surgical instruments should be stored in the sterilizing trays of proper size lined with soft silicone mats. Instruments should not touch each other. We recommend using safety protectors made of PTFE, which are autoclavable. The photos below illustrate the way to fix a tip in a protector. Please insert the tips into PTFE protectors as shown in the picture:

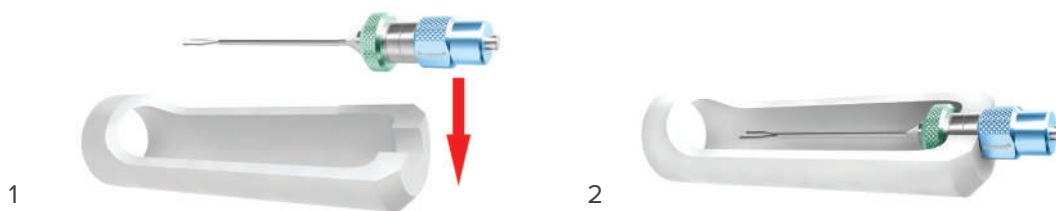

1. Match the nut indicating the gauge with the hub, press the tip gently. Make sure the branches do not touch the protector.
2. The tips in their final position — safely fixed by the protector.

Note: the tips should be sterilized in the protector to avoid any contact with other instruments.

ABBREVIATIONS

BRVO	Branch Retinal Vein Occlusion
BSS	Balanced Salt Solution
CPM	Cuts per Minute
CRVO	Central Retinal Vein Occlusion
DALK	Deep Anterior Lamellar Keratoplasty
DLEK	Deep Lamellar Endothelial Keratoplasty
DMEK	Descemet's Membrane Endothelial Keratoplasty
DSAEK	Descemet's Stripping Automated Endothelial Keratoplasty
DSEK	Descemet's Stripping Endothelial Keratoplasty
ECCE	Extracapsular Cataract Extraction
ERM	Epiretinal Membrane
I/A	Irrigation / Aspiration
ICL	Implantable Collamer Lens
ICRS	Intrastromal Corneal Ring Segments
ID	Inner Diameter
ILM	Internal Limiting Membrane
IOL	Intraocular Lens
LASEK	Laser-Assisted Sub-Epithelial Keratectomy
LASIK	Laser-Assisted in Situ Keratomileusis
LHD	Left Handed Doctor
LRI	Limbal Relaxing Incisions
MICS	Micro Incision Coaxial Surgery
MVR	Micro-vitreoretinal
OD	Outer Diameter
OVD	Ophthalmic Viscosurgical Device
PFC	Perfluorocarbon
PRK	Photorefractive Keratectomy
PVD	Posterior Vitreous Detachment
ReLEx SMILE	Refractive Lenticule Extraction Small Incision Lenticule Extraction
RHD	Right Handed Doctor
SMILE	Small Incision Lenticule Extraction
STSS	Stainless Steel
Ti	Titanium

A**Abdullayev**

3-024T	Abdullayev I & II Marker (for DSAEK/DMEK Grafts), Titanium, Length 135 mm	32
3-0231	Abdullayev Corneal Marker for Keratoplasty, Double-Ended (10.00 mm and 11.00 mm Diameters), with Central Marking Point, Length 146 mm, Round Titanium Handle	39
4-261S	Abdullayev DMEK Grasping Forceps, Length 82 mm, Stainless Steel	32
3-0230	Abdullayev Scleral Marker for Keratoplasty, Double-Ended (16.00 mm and 16.50 mm Diameters), Length 153 mm, Round Titanium Handle	39
4-2132T	Acrylic Lens Insertion Forceps, Flat Handle, Length 105 mm, Titanium	62
4-2132S	Acrylic Lens Insertion Forceps, Flat Handle, Stainless Steel	62
2-064T	Adler Wound Gauge, 2.00 - 2.50 mm Ranges, Titanium	37

Adson

4-0740T	Dressing Forceps, Flat Handle, Length 124 mm, Titanium	61
4-0740S	Dressing Forceps, Flat Handle, Stainless Steel	61
4-0741S	Fixation Forceps, 0.50 mm, 1x2 Teeth, Length 124 mm, Stainless Steel	61
4-0741T	Fixation Forceps, 0.50 mm, 1x2 Teeth, Length 124 mm, Titanium	61

Akahoshi

4-2138T	Forceps For Acrylic Lens, Cross Action, Length 108 mm, Titanium	62
7-1163S	Hybrid Combo Prechopper, Straight, Cross Action, Max Opening 2.80 mm, Round Handle, Length 121 mm, Stainless Steel	79

Alger Brush

16-051-2.5	Power handle with 2.5 mm Round Diamond Dusted Burr	119
16-050-3.5	Power handle with 3.5 mm Round Medium Diamond Dusted Burr	119
16-050-5.0	Power handle with 5.0 mm Disk Shaped Diamond Dusted Burr	119
16-141	Power handle with 0.5 mm Tungsten Burr	119
16-140	Power handle with 1.0 mm Tungsten Burr	119

Replacement Burr

16-143B	Tungsten, 0.5 mm Diameter	119
16-142B	Tungsten, 1.0 mm Diameter	119
16-051-2.5B	Diamond Dusted, Round, 2.5 mm Diameter	119
16-051-3.5B	Diamond Dusted, Round, 3.5 mm Diameter	119
16-052-5.0B	Diamond Dusted, Disk Shaped, 5.0 mm Diameter	119

Anel Lacrimal Cannula

15-035-23C	Curved, 23 Ga, special long mount blunt tip	118
15-035-25C	Curved, 25 Ga, special long mount blunt tip	118
15-035-23S	Straight, 23 Ga, special long mount blunt tip	118
15-035-25S	Straight, 25 Ga, special long mount blunt tip	118

Anterior Chamber Cannula (Rycroft)

21-R2023	23 Ga x 22 mm, 4 mm bend length, 10 per Box	25
21-R2030	30 Ga x 22 mm, 4 mm bend length, 10 per Box	25
21-R2027-8	27 Ga x 22 mm, 8 mm bend length, 10 per Box	25
7-101	Anterior/Posterior Capsule Polisher, Angled 135°, Length 120 mm, Round Titanium Handle	84

AquaFree Hydrophobic IOLs

IOLs	AquaFree Yellow Aspheric Hydrophobic	13
IOLs	AquaFree Yellow Aspheric Hydrophobic Preloaded	13

Aspiration Handpiece For Bimanual Technique, Curved

7-082	21 Ga, One Top Port 0.35 mm, Length 104 mm, Titanium Handle	86
7-0821	22 Ga, One Top Port 0.35 mm, Length 104 mm, Titanium Handle	86
7-0821-23	23 Ga, One Top Port 0.30 mm, Length 104 mm, Titanium Handle	86
7-0826	23 Ga, 1.00x0.30 mm Port, Polished Ball Tip, Curved, Length 104 mm, Titanium Handle	86
4-260T	ARTISAN® Implantation Forceps, Flat handle, Length 100 mm, Titanium	63
15-001-23	Atkinson Retrobulbar Needle, 23 Ga x 38.00 mm	113
12-412	Avci Foreign Body Forceps, 17 Ga, Tip Only	139
7-135	Axe Quick Chopper, Angled, 10.00 mm from Bend to Tip, Length 120 mm, Round Titanium Handle	81

B

15-031	Bailey Lacrimal Cannula, 23 Ga	118
15-373-25	Banaji LASIK Irrigation Cannula, 4 Ports, Curved, 25 Ga	117
1-020S	Bard Parker Handle, Flat, Length 125 mm, Stainless Steel	36

Backflush Handle

12-6000	Active Aspiration, Length 118 mm, Titanium	148
12-6010	Passive Aspiration, Length 108 mm, Titanium	148
11-1223	Barraquer Iris Scissors, Blunt Tips, 7.00 mm Blades, Flat Serrated Squeeze Action Handle with Polished Finish, Length 55 mm, Stainless Steel	94

Backflush Instrument		
12-5162H	with brush tip, disposable, 23 Ga, 6 per Box	148
12-5160H	with brush tip, disposable, 25 Ga, 6 per Box	148
12-5167H	with brush tip, disposable, 27 Ga, 6 per Box	148
12-5164H	with Charles Flute tip, disposable, 23 Ga, 6 per Box	148
12-5156H	with Charles Flute tip, disposable, 25 Ga, 6 per Box	148
12-5492H	with Charles Flute tip, disposable, 27 Ga, 6 per Box	148
12-5161H	with soft tip, disposable, 23 Ga, 6 per Box	148
12-5152H	with soft tip, disposable, 25 Ga, 6 per Box	148
12-5491H	with soft tip, disposable, 27 Ga, 6 per Box	148
Barraquer Needle Holder		
Extra Fine Jaws		
8-050T	8.00 mm, Curved with Lock, Long Size, Length 125 mm, Titanium	88
8-024T	8.00 mm, Curved with Lock, Small Size, Length 100 mm, Titanium	88
8-051T	8.00 mm, Curved, without Lock, Long Size, Length 125 mm, Titanium	88
8-051S	8.00 mm, Curved, without Lock, Long Size, Length 125 mm, Stainless Steel	88
8-045T	8.00 mm, Curved, without Lock, Medium Size, Length 115 mm, Titanium	88
8-045S	8.00 mm, Curved, without Lock, Medium Size, Length 115 mm, Stainless Steel	88
8-025T	8.00 mm, Curved, without Lock, Small Size, Length 100 mm, Titanium	88
Fine Jaws		
8-070T	12.00 mm, Curved, with Lock, Long Size, Length 125 mm, Titanium	88
8-040T	12.00 mm, Curved, with Lock, Medium Size, Length 115 mm, Titanium	88
8-040S	12.00 mm, Curved, with Lock, Medium Size, Length 115 mm, Stainless Steel	88
8-020T	12.00 mm, Curved with Lock, Small Size, Length 100 mm, Titanium	88
8-071T	12.00 mm, Curved, without Lock, Long Size, Length 125 mm, Titanium	88
8-071S	12.00 mm, Curved, without Lock, Long Size, Length 125 mm, Stainless Steel	88
8-041T	12.00 mm, Curved, without Lock, Medium Size, Length 115 mm, Titanium	88
8-041S	12.00 mm, Curved, without Lock, Medium Size, Length 115 mm, Stainless Steel	88
8-021T	12.00 mm, Curved, without Lock, Small Size, Length 100 mm, Titanium	88
Standard Jaws		
8-060T	12.00 mm, Curved with Lock, Long Size, Length 125 mm, Titanium	88
8-030T	12.00 mm, Curved, with Lock, Medium Size, Length 115 mm, Titanium	88
8-010T	12.00 mm, Curved with Lock, Small Size, Length 100 mm, Titanium	88
8-061T	12.00 mm, Curved, without Lock, Long Size, Length 125 mm, Titanium	88
8-031T	12.00 mm, Curved, without Lock, Medium Size, Length 115 mm, Titanium	88
8-031S	12.00 mm, Curved, without Lock, Medium Size, Length 115 mm, Stainless Steel	88
8-011T	12.00 mm, Curved, without Lock, Small Size, Length 100 mm, Titanium	88
8-013T	12.00 mm, Straight, without Lock, Small Size, Length 100 mm, Titanium	88
Strong Jaws		
8-090T	12.00 mm, Curved, with Lock, Long Size, Length 125 mm, Titanium	88
8-091T	12.00 mm, Curved, without Lock, Length 125 mm, Titanium	88
8-091S	12.00 mm, Curved, without Lock, Length 125 mm, Stainless Steel	88
Barraquer Temporal Speculum		
Solid Blades		
14-0231	Child size, 11.00 mm Blades, Length 35 mm, Stainless Steel	112
14-0241S	Newborn Size, 5.00 mm Blades, Length 28 mm, Stainless Steel	112
14-0221S	Adult Size, 14.00 mm Blades, Length 40 mm, Stainless Steel	112
14-0222S	Premature Size, 4.00 mm Blades, Length 28 mm, Stainless Steel	112
Wire Blades		
14-0287S	Open 10.00 mm Blades, Child Size, Length 36 mm, Stainless Steel	112
14-024S	Infant Size, 10.00 mm Blades, Length 38 mm, Stainless Steel	112
14-022S	Adult Size, 14.00 mm Blades, Length 45 mm, Stainless Steel	112
14-022D	Disposable, Adult Size, 6 per Box	20
14-023S	Child Size, 11.00 mm Blades, Length 38 mm, Stainless Steel	112
14-0281S	Fenestrated 11.00 mm Blades, Child Size, Length 36 mm, Stainless Steel	112
14-028S	Fenestrated 14.00 mm Blades, Adult Size, Length 40 mm, Stainless Steel	112
14-0244S	Newborn Size, 4.00 mm Blades, Length 25 mm, Stainless Steel	112
14-026S	Child Size, Open 11.00 mm Blades, Length 40 mm, Stainless Steel	112
14-025S	Adult Size, Open 14.00 mm Blades, Length 45 mm, Stainless Steel	112
14-0286S	Adult Size, 14.00 mm Open Blades, Length 45.00 mm, Stainless Steel	112
14-0282S	Adult Size, Round Open 14.00 mm Blades, Length 40 mm, Stainless Steel	112
5-034	Bechert Nucleus Rotator, Angled, "Y" Shaped Tip, Length 121 mm, Round Titanium Handle	71

5-034S	Bechert Nucleus Rotator, Angled, "Y" Shaped Tip, Length 121 mm, Round Handle, Stainless Steel	71
10-091	Beehler Pupil Dilator with Plunger, Four Prongs, 17 Ga, Curved, Length 130 mm, Titanium Handle	91
10-083	Beehler Pupil Dilator, Four Prongs, Intraocular Handle, 17 Ga, Curved Shaft, Length 130 mm, Titanium Handle	91
16-138	Belz Lacrimal Sac Rounger, Polished finish, Length 185 mm, Stainless Steel	121
13-147	Bicalto Guide, Blunt tip, Angled, Length 121 mm, Round Titanium Handle	107
15-055-19	Bishop Harmon Anterior Chamber Cannula, 19 Ga x 25.00 mm, Angled, Spatulated	113
4-0607S	Bishop-Harmon Suturing Forceps, 0.30 mm, 1x2 Teeth, 5.00 mm Tying Platform, Length 87 mm, Stainless Steel	68
1-010T	Blade Holder, Round Handle, with End Lock, Length 95 mm, Titanium	36
4-2300T	Bonaccolto Utility Forceps, Flat Handle, 15.00 mm Atraumatic Serrations, Length 100 mm, Titanium	70
4-2300S	Bonaccolto Utility Forceps, Flat Handle, 15.00 mm Atraumatic Serrations, Length 100 mm, Stainless Steel	70
3-090T	Bores Axis Marker, Length 123 mm, Titanium	39
3-090S	Bores Axis Marker, Length 123 mm, Stainless Steel	39
3-091T	Bores Axis Marker, Length 123 mm, Titanium	39
Bowman Lacrimal Probe		
9-010S	Size 0000-000, Length 133 mm, Stainless Steel	89
9-011S	Size 00-0, Length 133 mm, Stainless Steel	89
9-012S	Size 1-2, Length 133 mm, Stainless Steel	89
9-013S	Size 3-4, Length 133 mm, Stainless Steel	89
9-014S	Size 5-6, Length 133 mm, Stainless Steel	89
9-015S	Size 7-8, Length 133 mm, Stainless Steel	89
15-057	Bracken Flattened Anterior Chamber Cannula, 19 Ga x 23.00 mm	114
Braunstein Fixed Caliper		
2-101T	3.00-3.50 mm, Length 80 mm, Titanium	37
2-100S	3.50-4.00 mm, Length 80 mm, Stainless Steel	37
2-100T	3.50-4.00 mm, Length 80 mm, Titanium	37
Brush Tip Cannula		
12-5162	23 Ga, 5 per box 233	149
12-5160	25 Ga, 5 per box 233	149
12-5167	27 Ga, 5 per box 234	149
13-1091-23	BRVO Knife, 23 Ga, Length 132 mm, Round Titanium Handle	140
16-062	Bunge Evisceration Spoon, Large, Length 141 mm, Round Titanium Handle	122
16-061	Bunge Evisceration Spoon, Small, Length 137 mm, Round Titanium Handle	122
15-379-25	Buratto LASIK Irrigation Cannula 25 Ga, 45° Angled Triport	117
C		
15-450-27	Cannula for DALK Procedure, 0.2 mm port, 27 Ga	117
Capsulorhexis Forceps		
4-0374	with Internal Ruler, 23 Ga, 2 Engravings, with Lock, Micro Jaws, Tip Only	52
4-0375	with Internal Ruler, 23 Ga, 6 Engraving, with Lock, Micro Jaws, Tip Only	52
4-0395	with Scale(2.50 mm, 5.00 mm From The Tip), Cross Action, Curved Stainless Steel Jaws 8.50 mm, For 1.50 mm Incisions, Flat Titanium Handle, Length 110 mm	46
4-0394	with Scale (2.50 mm, 5.00 mm From The Tip), Cross Action, Curved Stainless Steel Jaws 8.50 mm, For 1.50 mm Incisions, Length 110 mm, Round Titanium Handle	49
4-0395S	with Scale (2.50 mm, 5.00 mm From The Tip), Cross Action, Curved Stainless Steel Jaws 8.50 mm, For 1.50 mm Incisions, Length 110 mm, Flat Stainless Steel Handle	49
4-0395T	with Scale (2.50 mm, 5.00 mm From The Tip), Cross Action, Curved Titanium Jaws 8.50 mm, For 1.50 mm Incisions, Length 110 mm, Flat Titanium handle	49
4-0396	with Scale (2.50 mm, 5.00 mm From The Tip), Cross Action, Straight Stainless Steel Jaws 8.50 mm, For 1.50 mm Incisions, Length 110 mm, Flat Titanium Handle	49
4-03791	with View Port, 23 Ga, 7 Engravings, Reduced Length, Gently Curved Tube, Micro Jaws 0.80 mm, Tip Only	53
4-0391S	Inamura Style, Cross Action, S-R, 10.00 mm Curved Jaws, Length 115 mm, Stainless Steel	48
4-0392S	Inamura Style, S-R, Cross Action, 12.00 mm Curved Jaws, Length 117 mm, Stainless Steel	48
4-033S	Small-incision, with Double Cross-Action and Scale, Cystotome Tips, Micro-Thin Jaws, for 1.50 mm incisions, Flat Handle, Length 105 mm, Stainless Steel	49
13-152S	Carlson DSEK Smoother, Angled/ Vaulted Shaft, Length 119 mm, Stainless Steel	101
4-2141T	Cartridge Loading Forceps, For Inserting IOL Into A, B, C, D Cartridges, Thin And Smooth Jaws, Length 109 mm, Titanium	63
Cartridge for IOL Injector		
CAT-22	for 2.20 mm Incision, disposable, 20 per Box	15
CAT-24	for 2.40 mm Incision, disposable, 20 per Box	15
CAT-27	for 2.70 mm Incision, disposable, 20 per Box	15

Castroviejo		
2-010S	Caliper, Measure 0-20 mm, Both Sides Scale, Length 87 mm, Stainless Steel	37
2-010T	Caliper, Measure 0-20 mm, Both Sides Scale, Length 87 mm, Titanium	37
4-0541T	Colibri Corneal Forceps, 0.12 mm, 1x2 Teeth, Flat Handle, Length 107 mm, Titanium	58
11-0241S	Corneal Section Scissors, Left, 14.00 mm Blades, Lower Blade 0.50 mm Longer, Length 106 mm, Stainless Steel	92
11-024S	Corneal Section Scissors, Right, 14.00 mm Blades, Lower Blade 0.50 mm Longer, Length 106 mm, Stainless Steel	92
13-052	Cyclodialysis Spatula, 0.75 mm x 10.00 mm Blades, Length 124 mm, Round Titanium Handle	98
13-051	Cyclodialysis Spatula, 1.00 mm Wide, 10.00 mm Long Tip, Length 124 mm, Round Titanium Handle	98
13-050	Double-Ended Cyclodialysis Spatula, 0.50 mm Width, 10.00 mm & 15.00 mm Blades, Length 136 mm, Round Titanium Handle	98
9-060T	Double-Ended Lacrimal Dilator, Size 1 & 2, Length 100 mm, Titanium	89
9-060S	Double-Ended Lacrimal Dilator, Size 1 & 2, Length 100 mm, Stainless Steel	89
4-0822T	Fixation Forceps, 0.50 mm, 1x2 Teeth, without Tying Platform, Length 109 mm, Titanium	61
Corneal Scissors		
11-010S	Corneal Scissors, Left, Curved Blunt Tips, 11.00 mm Blades, Length 100 mm, Stainless Steel	92
11-0101S	Corneal Scissors, Right, Curved Blunt Tips, 11.00 mm Blades, Length 100 mm, Stainless Steel	92
11-012S	Universal Corneal Scissors, Blunt Tips, 11.00 mm Blades, Length 106 mm, Stainless Steel	92
11-011S	Universal Corneal Scissors, Small, Blunt Tips, 7.50 mm Blades, Length 102 mm, Stainless Steel	92
11-012D	Universal, Blunt Tips, Disposable, 6 per Box	21
11-015S	Curved Corneal Scissors, Medium, Blunt Tips, 16.00 mm Blades, Length 110 mm, Stainless Steel	92
Needle Holder		
8-0921T	Straight, with Lock, Delicate jaws 13.50 mm, 122 mm Length, Titanium	87
8-0921S	Delicate jaws 13.50 mm, Straight, with Lock, Length 122 mm, Stainless Steel	87
8-096T	Delicate Jaws, Gripping Surface 8.00 mm, Curved, without Lock, Length 135 mm, Titanium	87
8-096S	Delicate Jaws, 8.00 mm, Curved, without Lock, Length 135 mm, Stainless Steel	87
8-100T	Standart Jaws, Gripping Surface 11.00 mm, Curved, with Lock, Length 140 mm, Titanium	87
8-100S	Standart Jaws, 11.00 mm, Curved, with Lock, Length 140 mm, Stainless Steel	87
14-061T	Speculum, Flat branches, Fenestrated 14.00 mm Blades, Adult Size, Length 85 mm, Titanium	109
Suturing Forceps		
4-0600S	0.12 mm, 1x2 Teeth, 6.00 mm Tying Platform, Flat Handle, Length 110 mm, Stainless Steel	68
4-0600T	0.12 mm, 1x2 Teeth, 6.00 mm Tying Platform, Flat Handle, Length 110 mm, Titanium	68
4-0601S	0.30 mm, 1x2 Teeth, 6.00 mm Tying Platform, Flat Handle, Length 108 mm, Stainless Steel	68
4-0601T	0.30 mm, 1x2 Teeth, 6.00 mm Tying Platform, Flat Handle, Length 108 mm, Titanium	68
4-0602S	0.50 mm, 1x2 Teeth, 6.00 mm Tying Platform, Flat Handle, Length 108 mm, Stainless Steel	68
4-0602T	0.50 mm, 1x2 Teeth, 6.00 mm Tying Platform, Flat Handle, Length 108 mm, Titanium	68
4-0600D	0.12 mm, Disposable, 6 per Box	21
Catalano		
4-055T	Corneal Forceps, 0.12 mm, 1x2 Teeth, Round Handle, Length 105 mm, Titanium	58
4-055S	Corneal Forceps, 0.12 mm, 1x2 Teeth, Round Handle, Length 105 mm, Stainless Steel	58
4-056T	Corneal Forceps, 0.30 mm, 1x2 Teeth, Round Handle, 5 mm Tying Platform, Length 105 mm, Titanium	58
4-057T	Corneal Forceps, 0.50 mm, 1x2 Teeth, Round Handle, 5 mm Tying Platform, Length 105 mm, Titanium	58
4-182T	Curved Micro Tying Forceps, 6.00 mm V-Groove Tying Platform, Length 106 mm, Titanium	69
Chang		
7-1271S	Chopper, Double Ended, LHD, Round Handle, Length 125 mm, Stainless Steel	82
7-127S	Chopper, Double Ended, RHD, Round Handle, Length 125 mm, Stainless Steel	82
15-0681	Nucleus Hydrodissector, 27 Ga x 16 mm	115
Charles Flute Cannula		
12-5164	23 Ga, 5 per Box	149
12-5156	25 Ga, 5 per Box	149
12-5492	27 Ga, 5 per Box	149
Cilia Forceps		
4-042S	Narrow, Flat Handle, Length 86 mm, Stainless Steel	54
4-042T	Narrow, Flat Handle, Length 86 mm, Titanium	54
4-043T	Wide, Flat Handle, Length 85 mm, Titanium	54
13-151S	Cindy Sweeper DSEK Spatula, Angled, Length 111 mm, Stainless Steel	101
12-2020	Claus Lucke Retinotomy Scissors with Bulbous Tip, 20 Ga, Tip Only	136
11-0501S	Clayman-Vannas Swan Neck Straight Scissors, Sharp Tips, 5.00 mm Blades, Smooth Handle, Length 81 mm, Stainless Steel	96
4-21431	Coaxial Angled ICL Loading Forceps, 20 Ga, Tip Only, Non Rotatable	65
8-120	Coaxial Needle Holder For IOL Suturing, Length 128 mm, Titanium Handle	88

Colibri Corneal Forceps		
4-050T	0.12 mm, 1x2 Teeth, Flat Handle, Length 84 mm, Titanium	57
4-050S	0.12 mm, 1x2 Teeth, Flat Handle, Length 84 mm, Stainless Steel	57
4-0501T	0.12 mm, 1x2 Teeth, Flat Handle, Length 77 mm, Titanium	57
4-0501S	0.12 mm, 1x2 Teeth, Flat Handle, Length 77 mm, Stainless Steel	57
4-054T	0.12 mm, 1x2 Teeth, 5.00 mm Tying Platform, Round Handle, Length 109 mm, Titanium	58
4-0540T	0.12 mm, 1x2 Teeth, 5.00 mm Tying Platform, Round Handle, Length 109 mm, Titanium	58
Colibri-Bonn Corneal Forceps		
4-0503S	0.12 mm, 1x2 Teeth, Flat Handle, Length 84 mm, Stainless Steel	57
4-0504T	0.12 mm, 1x2 Teeth, Flat Handle, Length 77 mm, Titanium	57
4-0504S	0.12 mm, 1x2 Teeth, Flat Handle, Length 77 mm, Stainless Steel	57
4-053T	0.12 mm, 1x2 Teeth, 5.00 mm Platform, Flat Handle, Length 115 mm, Titanium	58
7-1162S	Combo Prechopper For Sub-2.00 mm Coaxial MicroPhaco, Straight, Cross Action, Max Opening 2.00 mm, Round Handle, Length 121 mm, Stainless Steel	79
7-1161S	Combo Prechopper, Sharp&Blunt Blades, Straight, Cross Action, Max Opening 2.80 mm, Round Handle, Length 121 mm, Stainless Steel	79
4-1913T	Compressing Lid Forceps (MGD), Curved, Length 112 mm, Titanium	55
4-124S	Compressing Lid Forceps with Atraumatic Rollers, Length 107 mm, Stainless Steel	55
Corneal		
13-138	Dissector, Curved, Length 127 mm, Round Titanium Handle	100
13-137	Dissector, Straight, Length 125 mm, Round Titanium Handle	100
4-2019T	Donor Insertion Forceps, Round Handle, Length 125 mm, Titanium	59
3-140T	Transplant Marker, 7.00/11.00 mm, Length 123 mm, Titanium	40
11-035S	Scissors, Blunt Tips, 11.00 mm Curved Blades, Round Handle, Length 112 mm, Stainless Steel	92
11-034S	Scissors, Blunt Tips, 7.50 mm Curved Blades, Round Handle, Length 110 mm, Stainless Steel	92
4-0551T	Straight Forceps, Bonn-Catalano Type, 0.12 mm, 1x2 Teeth, Round Handle, Length 105 mm, Titanium	58
4-0551S	Straight Forceps, Bonn-Catalano Type, 0.12 mm, 1x2 Teeth, Round Handle, Length 105 mm, Stainless Steel	58
4-0551D	Bonn-Catalano Forceps, 0.12 mm, Disposable, 6 per Box	21
4-059T	Bonn Forceps, Straight, 0.12 mm, 1x2 Teeth, Small Size, Flat Handle, Length 72 mm, Titanium	58
4-058T	Bonn Forceps, Straight, 0.12 mm, 1x2 Teeth, Medium Size, Flat Handle, Length 94 mm, Titanium	58
4-058S	Bonn Forceps, Straight, 0.12 mm, 1x2 Teeth, Medium Size, Length 94 mm, Stainless Steel	58
Corneal Trephine Blades		
16-0300	6.00 mm diameter	123
16-0301	6.50 mm diameter	123
16-0303	7.00 mm diameter	123
16-0305	7.50 mm diameter	123
16-0306	7.75 mm diameter	123
16-0307	8.00 mm diameter	123
16-0308	8.25 mm diameter	123
16-0309	8.50 mm diameter	123
16-0310	9.00 mm diameter	123
16-0311	9.50 mm diameter	123
Crocodile Vitreoretinal Gripping Forceps		
12-304	20 Ga, Tip Only	133
12-304-23H	23 Ga, Attached to a Universal Handle, with RUMEX Flushing System	143
12-304-25H	25 Ga, Attached to a Universal Handle, with RUMEX Flushing System	143
12-304-23	23 Ga, Tip Only	133
12-304-25	25 Ga, Tip Only	133
12-304-23D	23 Ga, Stainless Steel, 6 per Box	145
12-304-25D	25 Ga, Stainless Steel, 6 per Box	145
12-304-23DP	23 Ga, Plastic Handle 360°, 6 per Box	146
12-304-25DP	25 Ga, Plastic Handle 360°, 6 per Box	146
12-304-27DP	27 Ga, Plastic Handle 360°, 6 per Box	146
7-1167S	Crozafon Prechopper, Round Handle, Length 118 mm, Stainless Steel	79
D		
16-153	Davis Foreign Body Spud, Length 123 mm, Round Titanium Handle	104
21-R7012	DCR Set - Angled 4.5 cm, 3 per Box	27
21-R7011	DCR Set - Straight 4.5 cm, 3 per Box	27
12-413	De Juan Diamond Dusted Pick Forceps, 20 Ga, Tip Only	139
2-036T	Degree gauge with Beveled Face, 12.00/16.00 mm Diameters, Length 132 mm, Titanium	38

Delicate Membrane Pick		
13-097-23	23 Ga	140
13-0979	25 Ga	140
13-097-27	27 Ga	140
Desmarres Chalazion Forceps		
4-1906T	Large, 31.00x17.40 mm Platform, Length 96 mm, Titanium	54
4-1912T	Medium, 24.00x16.00 mm Platform, Length 92 mm, Titanium	54
4-1912S	Medium, 24.00x16.00 mm Platform, Length 92 mm, Stainless Steel	54
4-1907T	Small, 19.80x10.40 mm Platform, Length 90 mm, Titanium	54
4-1907S	Small, 19.80x10.40 mm Platform, Length 90 mm, Stainless Steel	54
Desmarres Lid Retractor		
10-020	Size 0, 11.00 mm, Length 130 mm, Round Titanium Handle	90
10-020S	Size 0, 11.00 mm, Length 130 mm, Round Handle, Stainless Steel	90
10-021	Size 1, 13.00 mm, Length 130 mm, Round Titanium Handle	90
10-021S	Size 1, 13.0 mm, Length 130 mm, Round Handle, Stainless Steel	90
10-022	Size 2, 15.00 mm, Length 130 mm, Round Titanium Handle	90
10-022S	Size 2, 15.00 mm, Length 130 mm, Round Handle, Stainless Steel	90
10-023	Size 3, 17.00 mm, Length 130 mm, Round Titanium Handle	90
10-023S	Size 3, 17.00 mm, Length 130 mm, Round Handle, Stainless Steel	90
Diamond Knife		
6-00/6-030	Arcuate Incision, 1.00/0.20 mm Tapered Blade	74
6-00/6-020	Astigmatic and Arcuate Keratotomy, 1.00 mm Blade	74
Glaucoma Knife		
6-20/6-091	Crescent Blade, 1.50 mm, Length 117 mm, Angled Titanium Handle	75
6-20/6-092	Crescent Blade, 2.00 mm, Length 117 mm, Angled Titanium Handle	75
LRI Knife		
6-322/6-0531	20° Trifacet Blade, 1.00 mm, Calibration Mechanism with 3 Preset Depths Of 500, 550, and 600 microns, Length 125 mm, Titanium Handle	76
6-500/6-0531	20° Trifacet Blade, 0.20/1.00 mm, Preset Depth of 500 Microns, Length 110 mm, Straight Titanium Handle	76
6-500S/6-0531	20° Trifacet Blade, 0.20/1.00 mm, Preset Depth of 500 Microns, to be Used with a Slit Lamp, Length 78 mm, Short Titanium Handle	76
6-600/6-0531	20° Trifacet Blade, 0.20/1.00 mm, Preset Depth of 600 Microns, Straight, Length 110 mm, Titanium Handle	76
6-600S/6-0531	20° Trifacet Blade, 0.20/1.00 mm, Preset Depth of 600 Microns, to be Used with a Slit Lamp, Length 78 mm, Short Titanium Handle	76
Phaco Knife		
6-20/6-071	2.50 mm Clear Cornea Blade, Length 117 mm, Angled Titanium Handle	75
6-20/6-072	2.80 mm Clear Cornea Blade, Length 117 mm, Angled Titanium Handle	75
6-20/6-073	3.00 mm Clear Cornea Blade, Length 117 mm, Angled Titanium Handle	75
6-20/6-074	3.20 mm Clear Cornea Blade, Length 117 mm, Angled Titanium Handle	75
6-20/6-075	2.20 mm Clear Cornea Blade, Length 117 mm, Angled Titanium Handle	75
6-20/6-077	2.75 mm Clear Cornea Blade, Length 117 mm, Angled Titanium Handle	75
6-20/6-078	2.70 mm Clear Cornea Blade, Length 117 mm, Angled Titanium Handle	75
6-20/6-081	2.30 mm Clear Cornea Blade, Length 117 mm, Angled Titanium Handle	75
6-20/6-100	1.90/2.50 mm Trapezoid Self-Diving Blade, Length 117 mm, Angled Titanium Handle	75
6-20/6-101	2.70/3.20 mm Trapezoid Self-Diving Blade, Length 117 mm, Angled Titanium Handle	75
6-20/6-102	3.00/3.50 mm Trapezoid Self-Diving Blade, Length 117 mm, Angled Titanium Handle	75
6-20/6-104	2.30/2.80 mm Trapezoid Self-Diving Blade, Length 117 mm, Angled Titanium Handle	75
6-20/6-105	2.60/3.00 mm Trapezoid Self-Diving Blade, Length 117 mm, Angled Titanium Handle	75
6-20/6-107	2.00/2.30 mm Trapezoid Self-Diving Blade, Length 117 mm, Angled Titanium Handle	75
Side-Port Knife		
6-10/6-050	45° Single-Edge Blade, 1.00 mm, Straight, Length 120 mm, Titanium Handle	74
6-10/6-0501	45° Single-Edge Blade, 0.60 mm, Length 120 mm, Straight Titanium Handle	74
6-10/6-051	30° Single-Edge Blade, 1.00 mm, Straight, Length 120 mm, Titanium Handle	74
6-10/6-052	45° Double-Edge Blade, 1.00 mm, Straight, Length 120 mm, Titanium Handle	74
6-10/6-053	Trifacet Blade, 1.00 mm, Straight, Length 120 mm, Titanium Handle	74
6-10/6-0531	20° Trifacet Blade, 0.20/1.00 mm, Length 120 mm, Straight Titanium Handle	74
6-10/6-070	Lancet Blade, 1.00 mm, Straight, Length 120 mm, Titanium Handle	74
6-10/6-0701	Lancet Blade, 0.80 mm, Length 120 mm, Straight Titanium Handle	74
6-10/6-076	Brown-Osher, Five Facet Blade, 1.00 mm, Straight, Length 120 mm, Titanium Handle	74

Micro-Incision Diamond Knife		
6-20/6-140	1.50/1.00 mm Trapezoid Self-Diving Blade, Length 117 mm, Angled Titanium Handle	75
6-20/6-141	0.80/1.20 mm Phacanit Trapezoid Self-Diving Blade, Length 117 mm, Angled Titanium Handle	75
6-20/6-142	1.30/1.50 mm Trapezoid Self-Diving Blade, Length 117 mm, Angled Titanium Handle	75
6-20/6-143	1.50/1.80 mm Trapezoid Self-Diving Blade, Length 117 mm, Angled Titanium Handle	75
6-20/6-144	1.80/2.00 mm Trapezoid Self-Diving Blade, Length 117 mm, Angled Titanium Handle	75
6-20/6-145	1.80/2.20 mm Trapezoid Self-Diving Blade, Length 117 mm, Angled Titanium Handle	75
6-20/6-0551	0.55/1.00 mm, Zaldivar Knife For ICL, Length 117 mm, Angled Titanium Handle	75
21-602-1	Diamond Knife Cleaning Pack 82, 241	76
12-7523	Diamond-Dusted Retractable ILM Elevator, 23 Ga, disposable, 5 per Box	146
12-7525	Diamond-Dusted Retractable ILM Elevator, 25 Ga, disposable, 5 per Box	146
Disposable Knife		
Clear Corneal Knife		
CCD-22	w/Depth Indicators, 2.20 mm, Angled, 6 per Box	19
CCD-24	w/Depth Indicators, 2.40 mm, Angled, 6 per Box	19
CCD-26	w/Depth Indicators, 2.65 mm, Angled, 6 per Box	19
CCD-27	w/Depth Indicators, 2.75 mm, Angled, 6 per Box	19
CC-22	2.20 mm, Angled, 6 per Box	19
CC-24	2.40 mm, Angled, 6 per Box	19
CC-26	2.65 mm, Angled, 6 per Box	19
CC-27	2.75 mm, Angled, 6 per Box	19
CC-30	3.00 mm, Angled, 6 per Box	19
CR-20	Crescent, 2.00 mm, Angled, 6 per Box	19
MVR Knife		
VRA-19	19 Ga, Angled, 6 per Box, 228	19
VRS-19	19 Ga, Straight, 6 per Box, 228	19
VRA-20	20 Ga, Angled, 6 per Box, 228	19
VRS-20	20 Ga, Straight, 6 per Box, 228	19
VRA-23	23 Ga, Angled, 6 per Box, 228	19
VRS-23	23 Ga, Straight, 6 per Box, 228	19
PK-11	Paracentesis , 1.10 mm, Angled, 6 per Box	18
PD-60	Pre-Set , 600 µm Depth, 6 per Box	19
Side-Port Knife		
SP-15	1.00 mm, 15°, Straight, 6 per Box	18
SP-30	1.00 mm, 30°, Straight, 6 per Box	18
SP-45	1.00 mm, 45°, Straight, 6 per Box	18
Slit Knife		
SL-22	2.20 mm, Angled, 6 per Box	18
SL-24	2.40 mm, Angled, 6 per Box	18
SL-26	2.65 mm, Angled, 6 per Box	18
SL-27	2.75 mm, Angled, 6 per Box	18
SL-28	2.80 mm, Angled, 6 per Box	18
SL-32	3.20 mm, Angled, 6 per Box	18
Trapezoid Knife		
TR-10	1.20-1.40 mm, Angled, 6 per Box	18
TR-17	1.50-1.70 mm, Angled, 6 per Box	18
13-172	Dissector for DALK Procedure, 12 mm Length, Length 122 mm	103
11-036S	DLEK Scissors, Medium Curve, Long Blades, Length 102 mm, Stainless Steel	93
11-0361S	DLEK Scissors, Strong Curve, Long Blades, Length 102 mm, Stainless Steel	93
20-2041	Donnenfeld Femto Spatula, Length 122 mm, Round Titanium Handle	99
7-146	Donnenfeld Femto Splitter, Angled shaft, Curved Tip, Length 121 mm, Round Titanium Handle	83
20-061	Double-Ended Femto Spatula, Length 132 mm, Round Titanium Handle	99
10-034T	Double-Ended Orbital Globe Retractor-Elevator, 10.00/14.00 mm, Length 180 mm, Titanium	90
7-079	Double Phaco Spatula: Small Pupil Snapper Hook&Micro Finger, 142 mm	82
13-032	Double Spatula, 0.30 mm and 0.50 mm Wide, 12.00 mm Long, Length 134 mm, Round Titanium Handle	98
13-031	Double Spatula, 0.50 mm and 1.00 mm Wide, 12.00 mm Long, Length 144 mm, Round Titanium Handle	98
13-031S	Double Spatula, 0.50 mm and 1.00 mm Wide, 12.00 mm Long, Length 144 mm, Round Handle, Stainless Steel	98
Dressing Forceps		
4-070S	with Delicate Serrations, 6.00 mm Serrated Tips, Straight, Round Handle, Length 108 mm, Stainless Steel	60
4-072T	with Serrations, 12.00 mm Serrated Tips, Curved, Flat Handle, Length 100 mm, Titanium	60
4-071S	with Serrations, 12.00 mm Serrated Tips, Straight, Flat Handle, Length 100 mm, Stainless Steel	60
3-208T	DMEK/DSAEK "S" Marker, Length 115 mm, Titanium	40

DMEK Forceps		
4-262S	Cross-Action, Flat Handle, Length 110 mm, Stainless Steel	60
4-251	Cross-Action, Length 110 mm, Flat Titanium Handle	60
4-262	Cross-Action, Length 110 mm, Round Titanium Handle	60
Drysdale Nucleus Manipulator		
7-0931	Capsule Polisher Tip, 121 mm	81
7-093	Regular Tip, 121 mm	81
7-093D	Disposable, 6 per Box	20
12-5203	Dual Bore PFC Cannula, 23 Ga, 5 per Box	149
12-5205	Dual Bore PFC Cannula, 25 Ga, 5 per Box	149
E		
Eckardt End-Gripping Forceps		
12-410	Reusable, 20 Ga, Tip Only	137
12-410-23H	Reusable, 23 Ga, Attached to a Universal Handle, with RUMEX Flushing System, with Rumex Flushing System	143
12-410-25H	Reusable, 25 Ga, Attached to a Universal Handle, with RUMEX Flushing System, with Rumex Flushing System	143
12-410-23	Reusable, 23 Ga, Tip Only	137
12-410-25	Reusable, 25 Ga, Tip Only	137
12-410-27	Reusable, 27 Ga, Tip Only	137
12-410-23D	Disposable, 23 Ga, Stainless Steel, 6 per Box	145
12-410-25D	Disposable, 25 Ga, Stainless Steel, 6 per Box	145
12-410-23DP	Disposable, 23 Ga, Plastic Handle 360°, 6 per Box	146
12-410-25DP	Disposable, 25 Ga, Plastic Handle 360°, 6 per Box	146
12-410-27DP	Disposable, 27 Ga, Plastic Handle 360°, 6 per Box	146
10-035	Elevator for ICRS Implantation, Straight Shaft, Length 123 mm, Round Titanium Handle	107
4-138T	Elsching Superior Rectus Forceps, 1x2 teeth, 0.50 mm, Straight Shafts, Flat Serrated Handle, Length 108 mm, Titanium	68
End-Gripping Forceps		
12-420-23H	Reusable, Asymmetrical, 23 Ga, Attached to a Universal Handle, with RUMEX Flushing System, with Rumex Flushing System	143
12-420-25H	Reusable, Asymmetrical, 25 Ga, Attached to a Universal Handle, with RUMEX Flushing System, with Rumex Flushing System	143
12-420-23	Reusable, Asymmetrical, 23 Ga, Tip Only	133
12-420-25	Reusable, Asymmetrical, 25 Ga, Tip Only	133
12-420-27	Reusable, Asymmetrical, 27 Ga, Tip Only	133
12-4202-23	Reusable, Asymmetrical, Prolongated Branches for Myopic Eyes, 23 Ga, Tip Only	141
12-420-23D	Disposable, Asymmetrical, 23 Ga, Stainless Steel, 6 per Box	145
12-420-25D	Disposable, Asymmetrical, 25 Ga, Stainless Steel, 6 per Box	145
12-401	Reusable, with Extended Gripping Area at the End of the Tip, 20 Ga, Tip Only	138
12-4012	Reusable, with Extended Gripping Area at the End of the Tip, 23 Ga, Tip Only	138
12-400	Reusable, with Serrated Micro Jaws, 20 Ga, Tip Only	138
12-402	Reusable, with Nail-Shaped Jaws, 20 Ga, Tip Only	138
12-402-23	Reusable, with Nail-Shaped Jaws, 23 Ga, Tip Only	138
12-4089	Reusable, with Nail-Shaped Jaws, 25 Ga, Tip Only	138
12-411-25H	Reusable, Tano Asymmetrical, 25 Ga, Attached to a Universal Handle, with RUMEX Flushing System, with Rumex Flushing System	143
12-411-23H	Reusable, Tano Asymmetrical, 23 Ga, Attached to a Universal Handle, with RUMEX Flushing System, with Rumex Flushing System	143
12-411	Reusable, Tano Asymmetrical, 20 Ga, Tip Only	137
12-411-23	Reusable, Tano Asymmetrical, 23 Ga, Tip Only	141
12-411-25	Reusable, Tano Asymmetrical, 25 Ga, Tip Only	142
End Grasping Forceps		
12-4013	Reusable, Expanded Space between Branches, 23 Ga, Tip Only	141
12-4013H	Reusable, Expanded Space between Branches, 23 Ga, Attached to a Universal Handle, with RUMEX Flushing System, with Rumex Flushing System	143
12-4013-25H	Reusable, Expanded Space between Branches, 25 Ga, Attached to a Universal Handle, with RUMEX Flushing System, with Rumex Flushing System	143
13-139/I	Endothelial Stripper, Irrigating, for Descemet's Stripping, Length 104 mm, Titanium Handle	100
Enucleation Scissors		
11-090S	Curved, Blunt Tips, 38 mm Blades from Midscrew to Tip, Length 128 mm, Stainless Steel	97
11-091S	Curved, Blunt Tips, 45 mm Blades from Midscrew to Tip, Length 130 mm, Stainless Steel	97

7-025T	Ernest Nucleus Cracker, Flat Handle, Length 106 mm, Titanium	78
7-149S	Escaf prechopper, Straight, Round Handle, Length 120 mm, Stainless Steel	79
Eye Cautery		
16-042	Electric, Disposable, Elongated Tip, 10 per Box	120
16-041	Electric, Disposable, Fine Tip, 10 per Box	120
F		
15-033	Fasanella Lacrimal Cannula, 23 Ga x 42 mm	118
4-2108S	Faulkner Lens Holding Forceps, Angled shafts, Smooth Jaws, Length 105 mm, Stainless Steel	62
4-2301T	Fechtner Conjunctiva Forceps, Delicate Ring Jaws, Flat Handle, Length 108 mm, Titanium	54
4-2301S	Fechtner Conjunctiva Forceps, Delicate Ring Jaws, Flat Handle, Length 108 mm, Stainless Steel	54
20-202	FemtoLASIK Flap Spatula, Length 121 mm, Round Titanium Handle	106
20-201	FemtoLASIK Flap Spatula, Double Ended, Length 128 mm, Round Titanium Handle	106
5-036	Fenzl Hook, Angled, Length 121 mm, Round Titanium Handle	71
7-1251	Fine Phaconit Quick Chopper, 0.35 mm Width, Angled, Length 120 mm, Round Titanium Handle	81
7-1251S	Fine Phaconit Quick Chopper, 0.35 mm Width, Angled, Length 120 mm, Round Handle, Stainless Steel	81
16-0341T	Fine Thornton Phaco Fixation Ring with Swivel, 3/4 Open 14.00 mm Diameter Ring with Teeth, Length 98 mm, Titanium	120
16-036T	Fine Thornton Phaco Fixation Ring with Swivel, 3/4 Open 13.00 mm Diameter Ring with Teeth, Length 96 mm, Titanium	120
16-036S	Fine Thornton Phaco Fixation Ring with Swivel, 3/4 Open 13.00 mm Diameter Ring with Teeth, Length 96 mm, Stainless Steel	120
4-03751	Fine-Ikeda Capsulorhexis Forceps, 23 Ga, Tip Only	53
12-5188	Fixation Plate, 23 Ga, 1 per Box	144
12-000T	Flushing Adapter For Vitreoretinal Tips	134
Flieringa Rings		
16-030-14	14 mm, 1 each	120
16-030-15	15 mm, 1 each	120
16-030-16	16 mm, 1 each	120
16-030-17	17 mm, 1 each	120
16-030-18	18 mm, 1 each	120
16-030-19	19 mm, 1 each	120
16-030-20	20 mm, 1 each	120
16-030-21	21 mm, 1 each	120
16-030-22	22 mm, 1 each	120
4-246S	Florakis Endothelial Forceps, reversed tips, angled 75° 18, 66	59
4-247	Florakis Microinvasive Endothelial Forceps, 23 Ga, Tip Only	59
16-115	Flynn Scleral Depressor, for Depressing Pediatric Sclera, Length 100 mm, Round Titanium Handl	122
4-21741	Foldable Lens Removing Forceps, Length 114 mm, Squeeze Titanium Handle	64
4-034	Forceps for Corneal Endothelium Implantation, 23 Ga, Tip Only	59
4-0582S	Forceps For Femtosecond Laser Cataract Procedure, Cross Action, Flat Handle, Length 108 mm, Stainless Steel	53
4-2144T	Forceps for ICRS Implantation, with 1x1 Teeth, 0.30 mm Groove, Length 85 mm, Flat Handle, Titanium	57
7-077	Fukasaku Small Pupil Snapper Hook And Chopper, 121 mm	80
G		
5-060	Gass Retinal Detachment Hook, 13.00 mm Flat Hook, 1.50x0.70 mm Hole, Length 140 mm, Flat Titanium Handle	73
Gills-Vannas Capsulotomy Scissors		
11-0581S	Angled, Sharp Tips, 10.00 mm Blades, Flat Handle, Length 84 mm, Stainless Steel	96
11-058S	Curved, Sharp Tips, 10.00 mm Blades, Flat Handle, Length 88 mm, Stainless Steel	96
11-056S	Straight, Sharp Tips, 10.00 mm Blades, Flat Handle, Length 88 mm, Stainless Steel	96
15-119	Gills I/A Cannula with Silicone Tubing, Side by Side Front Opening, 23/23 Ga	115
15-378R	Gimbel LASIK Fountain Cannula, Right, 25 Ga x 25,4 mm	117
15-067	Girard Anterior Chamber Maintainer, 23 Ga x 5 mm Tip	114
Graefe Muscle Hook		
5-041	Size 1, 1.00x8.00 mm Hook, Length 135 mm, Flat Titanium Handle	72
5-041S	Size 1, 1.00x8.00 mm Hook, Length 135 mm, Flat Handle, Stainless Steel	72
5-042	Size 2, 1.50x10.00 mm Hook, Length 140 mm, Flat Titanium Handle	72
5-042S	Size 2, 1.50x10.00 mm Hook, Length 140 mm, Flat Handle, Stainless Steel	72
4-240	Guell DMEK Forceps, Angled Shafts, Highly Polished Broad Tips, Length 103 mm, Stainless Steel	59
H		
4-123S	Halsted Hemostatic Forceps, Curved, Long, Length 125 mm, Stainless Steel	67

4-122S	Halsted Hemostatic Forceps, Straight, Long, Length 125 mm, Stainless Steel	67
15-308T	Handle Microsurgical, Titanium, Male-Female, Length 80 mm	118
15-307T	Handle Microsurgical, Titanium, Male-Male, Length 80 mm	118
16-012S	Harms Trabeculotome, Left, 9 mm Long Pointed Tips with 3 mm Spread, Length 51 mm, Stainless Steel	123
16-013S	Harms Trabeculotome, Right, 9 mm Long Pointed Tips with 3 mm Spread, Length 51 mm, Stainless Steel	123
4-121S	Hartman Hemostatic Mosquito Forceps, Curved, Short, Length 90 mm, Stainless Steel	67
4-120S	Hartman Hemostatic Mosquito Forceps, Straight, Serrated jaws, Length 90 mm, Ring Handle, Stainless Steel	67
7-1071	He Phaco Chopper, LHD, 45° Angled, Wedge Shaped, Length 120 mm, Round Titanium Handle	81
7-1061	He Phaco Chopper, RHD, 45° Angled, Wedge Shaped, Round Handle, Length 120 mm, Round Titanium Handle	81
20-001	Hockey Epithelium Removal Knife, Length 128 mm, Round Titanium Handle	129
20-001S	Hockey Epithelium Removal Knife, Length 128 mm, Round Handle, Stainless Steel	129
Hoffer Optical Zone Marker, with Cross Hairs		
3-0211T	5.00 mm, Length 130 mm, Titanium	40
3-0212T	5.50 mm, Length 130 mm, Titanium	40
3-0213T	6.00 mm, Length 130 mm, Titanium	40
3-0216T	7.50 mm, Length 130 mm, Titanium	40
3-0217T	8.00 mm, Length 130 mm, Titanium	40
3-0218T	8.50 mm, Length 130 mm, Titanium	40
3-0219T	9.00 mm, Length 130 mm, Titanium	40
11-135	Holland Spatulated DALK Scissors, Left, Micro blades, Delicate Shortened Outer Blade, Rounded Blunt Tips, Length 100 mm, Stainless Steel	93
11-134	Holland Spatulated DALK Scissors, Right, Micro blades, Delicate Shortened Outer Blade, Rounded Blunt Tips, Length 100 mm, Stainless Steel	93
7-142	Holz Capsule Polisher, Angled Shaft, Texturized Bottom And Sharpened Ridge At The Top For Delicate Polishing, Length 123 mm, Round Titanium Handle	84
4-0502S	Hoskin Type Colibri Forceps, Pierced Tips, Flat Handle, Length 84 mm, Stainless Steel	57
Hydrophilic IOLs		
IOLs	Hydro-4 Aspheric	14
IOLs	Hydro-Sense Aspheric	14
IOLs	Hydro-Sense Aspheric Yellow	14
Hydrophobic IOLs		
IOLs	AquaFree Yellow Aspheric Hydrophobic	13
IOLs	AquaFree Yellow Aspheric Hydrophobic Preloaded	13
Hydrodissector		
21-R4027	Flattened, Angled 10 mm 27 Ga x 22 mm, 10 per Box	26
21-R4427	Round end, angled 10 mm 27 Ga x 22 mm, 10 per Box	26
21-R4025	Pearce, Flattened, Angled 8 mm, 25 Ga	26
I		
I/A Set		
7-0821D	I/A Set, Disposable, 21 Ga	22
7-0823D	I/A Set, Disposable, 23 Ga	22
I/A Tip		
7-080/45	I/A Tip, Angled 45°, Stainless Steel	85
7-080/90	I/A Tip, Angled 90°, Stainless Steel	85
7-080/BC	Binkhorst I/A Tip, Stainless Steel	85
7-080/20	Thornton 20° Angled I/A Tip, Stainless Steel	85
7-080/ST	Straight I/A Tip, Stainless Steel	85
7-080/SIM	Simcoe I/A Tip, Stainless Steel	85
4-20111S	ICL Cartridge Loading Forceps, Angled 30° Long Jaws, Round Handle, Length 120 mm, Stainless Steel	65
4-20111T	ICL Cartridge Loading Forceps, Angled 30° Long Jaws, Round Handle, Length 120 mm, Titanium	65
4-03761	Ikeda Micro Capsulorhexis Forceps, 23 Ga, Tip Only	53
7-11651S	Inamura Eagle Prechopper, Straight, Cross Action, Max Opening 1.80 mm, Round Handle, Length 121 mm, Stainless Steel	79
7-1165S	Inamura Eagle Prechopper, Straight, Cross Action, Max Opening 2.80 mm, Round Handle, Length 121 mm, Stainless Steel	79
12-026	Infusion Cannula 6.0 mm, Reusable, 1 piece	151
8-102S	Ing's Needle Holder/Scissors, Straight, Used To Cut Suture Only, Long Jaws 15.00 mm, Length 105 mm, Stainless Steel	87
16-253	Injector for Capsular Ring with Irrigation, Length 162 mm, Titanium Handle	120
12-5187	Instrument Cannula Inserter, 23 Ga, 1 per Box	144
Intraocular		
7-075	Manipulator with Ball Tip, Angled, 0.50 mm Ball Tip, Length 121 mm, Round Titanium Handle	80

7-074	Manipulator with Ball Tip, Straight, 0.50 mm Ball Tip, Round Titanium Handle, Length 123 mm	80
8-1211-23	Needle Holder, 23 Ga, Tip Only	87
4-1891	Tying Forceps, 23 Ga, Tip Only	70
4-2145	IOL Grasping Forceps, 21 Ga, Tip Only	63
IOLs - Hydrophilic		
IOLs	Hydro-4 Aspheric	14
IOLs	Hydro-Sense Aspheric	14
IOLs	Hydro-Sense Aspheric Yellow	14
IOLs - Hydrophobic		
IOLs	AquaFree Yellow Aspheric Hydrophobic	13
IOLs	AquaFree Yellow Aspheric Hydrophobic Preloaded	13
IOL Injector		
VE2200	Disposable Viscoject eco Injector for 2.2 mm incisions	15
16-2806	Reusable, for A, B, C Cartridges with Plunger Mechanism and Reverse Inner Spring, Length 212 mm, Titanium Handle with Ring	120
16-2807	Reusable, for D Cartridge with Plunger Mechanism and Reverse Inner Spring, Length 187.5 mm, Titanium Handle	121
16-2808	Reusable, for D Cartridge with Plunger Mechanism and Reverse Inner Spring, Length 212 mm, Titanium Handle with Ring	120
16-2853	Reusable, NaviJect™, Handle with Ring, Length 178,5 mm	121
Iris Forceps		
4-102S	1x2 Teeth, Curved, Flat Serrated Handle, Length 72 mm, Stainless Steel	66
4-101S	1x2 Teeth, Straight, Flat Serrated Handle, Length 72 mm, Stainless Steel	66
4-100S	with Serrations, Flat Serrated Handle, Straight shafts, Length 72 mm, Stainless Steel	66
Iris Retractors		
10-5016-1	Disposable, 1 pack of 4 pcs (4 retractors)	91
10-5067-1	Disposable, 1 pack of 5 pcs (5 retractors)	91
10-5127	Reusable, 1 pack of 6 pcs (6 retractors)	91
5-020	Iris Hook, 1.0 mm, Angled, Round Handle, Length 121 mm	73
Iris Scissors		
11-081S	Curved, Sharp Tips, 28.00 mm Blades, Ring Handle, Length 115 mm, Stainless Steel	93
11-080S	Straight, Sharp Tips, 28.00 mm Blades, Ring Handle, Length 115 mm, Stainless Steel	93
7-080/AH	Irrigation-Aspiration Handle	85
Irrigating Cannula		
15-049-30	Straight, Blunt Tip, 30 Ga x 25 mm, Polished	114
15-049-23	Straight, Blunt Tip, Polished, 23 Ga x 25 mm	114
Irrigating Cystotome		
21-R3027	Formed 27 Ga x 16 mm, 10 per Box 39	26
Irrigation Handpiece For Bimanual Technique		
7-081	Curved, 21 Ga, Two Ports on Side 35 mm	85
7-0813	Curved, 21 Ga, Two Ports on Side 50 mm	85
7-081-23	Curved, 23 Ga, Two Ports on Side 35 mm	85
7-0811	Stodulka, Enhanced, Curved, 21 Ga	85
J		
15-1149R	J Shaped I/A Cannula Right, Regular, 23/23 Ga	115
Jameson		
4-130S	Muscle Forceps, Left, 6 teeth, Slide Lock, Length 100 mm, Stainless Steel	67
4-131S	Muscle Forceps, Right, 6 teeth, Slide Lock, Length 100 mm, Stainless Steel	67
5-0401	Muscle Hook, 1.50 mm Bulbous Tip, 8.00 mm Flat Hook, Length 128 mm, Flat Titanium Handle	72
5-040	Muscle Hook, 2.00 mm Bulbous Tip, 9.50 mm Flat Hook, Length 135 mm, Round Titanium Handle	72
5-040S	Muscle Hook, 2.00 mm Bulbous Tip, 9.50 mm Flat Hook, Length 135 mm, Round Handle, Stainless Steel	72
15-1067	Jaymce Anterior Chamber Maintainer, Bulbous Tip 4 mm, 20 Ga	114
15-159-25	Jensen Capsule Polisher, Curved, Olive sand blasted tip 25 Ga	116
15-159-27	Jensen Capsule Polisher, Curved, Olive sand blasted tip 27 Ga	116
Jeweler Forceps		
4-113T	# 3C, Straight, Length 110 mm, Titanium	66
4-111T	# 5, Straight, Length 110 mm, Titanium	66
4-115T	# 7, Curved, Length 110 mm, Titanium	66
John		
13-182	Dexatome DMEK/DSAEK Spatula, Strongly Vaulted Shaft, Length 119 mm, Round Titanium Handle	102
13-1491	DSAEK Descemet's Stripper, "T" Shape, Length 121 mm, Round Titanium Handle	102

3-204T	DSAEK Double-Ended Marker 8.00/9.00 mm, Length 143 mm, Titanium	40
13-184	DSAEK Glider, Length 114 mm, Round Titanium Handle	102
13-183	DSAEK Stromal Scrubber, Strongly Vaulted Shaft, Length 120 mm, Round Titanium Handle	102
K		
8-080T	Kalt Needle Holder, Standard Straight 10.50 mm Jaws, Length 135 mm, Titanium	87
7-0201T	Kansas-Alfonso Nucleus Fragment Removing Forceps, with Teeth, Flat Handle, Length 107 mm, Titanium	78
11-020S	Katzin Corneal Transplant Scissors, Left, Blunt Tips, Strongly Curved, Length 100 mm, Stainless Steel	92
11-0201S	Katzin Corneal Transplant Scissors, Right, Blunt Tips, Strongly Curved, Length 100 mm, Stainless Steel	92
4-03771	Kawai Capsulorhexis Forceps, 23/25 Ga, Tip Only	53
12-415	Kawai ILM Forceps, 25 Ga, Tip Only	137
16-011	Kelly Descemet's Membrane Punch, 0.75 mm Diameter, Length 131 mm	122
16-011S	Kelly Descemet's Membrane Punch, 0.75 mm Diameter, Length 131 mm, Stainless Steel	122
15-025	Kelman Sharp Irrigating Cystotome, 25 Ga x 32 mm	116
Kelman-McPherson Tying Forceps		
4-092S	Angled Shafts, with 10.00 mm Tying Platforms, Length 86 mm, Stainless Steel	69
4-092T	Angled Shafts, with 10.00 mm Tying Platform, Length 86 mm, Titanium	69
4-090T	Angled Shafts, with 4.00 mm Tying Platform, Length 81 mm, Titanium	69
4-091S	Angled Shafts, with 8.00 mm Tying Platform, Length 84 mm, Stainless Steel	69
16-136	Kerrison Ronger, Size 0, 3.00 mm Wide, 9.00 mm Opening, Polished finish, Length 140 mm, Stainless Steel	121
Kershner		
Capsulorhexis Forceps		
4-03731	Cystotome Tips, 23 Ga, with Lock, Tip Only	52
4-03741	Micro Jaws, Cystotome Tips, 23 Ga, with Lock, Tip Only	52
Reversible Speculum		
14-0601T	14.00 mm Solid Blades, Flat Branches, Length 70 mm, Titanium	109
14-0601S	14.00 mm Solid Blades, Flat Branches, Length 70 mm, Stainless Steel	109
14-060T	14.00 mm Solid Blades, Round Branches, Length 70 mm, Titanium	109
14-060S	14.00 mm Solid Blades, Round Branches, Length 70 mm, Stainless Steel	109
14-060A	with Aspiration, Adult Size, 14 mm Solid Blades, Length 70 mm	108
14-062T	14.00 mm Fenestarted Blades, Flat Branches, Length 70 mm, Titanium	109
Knapp		
11-101S	Curved Strabismus Scissors, Ring Handle, Length 115 mm, Stainless Steel	94
11-100S	Straight Strabismus Scissors, Ring Handle, Length 115 mm, Stainless Steel	94
10-014	Lacrimal Sac Retractor, Blunt 4x8.00 mm Four Prongs Tip, Length 140 mm	90
10-014S	Lacrimal Sac Retractor, Blunt 4x8.00 mm Four Prongs Tip, Length 140 mm, Stainless Steel	90
15-183	Knolle-Pearse Irrigating Vectis, 23 Ga, 3 port	115
7-070	Koch Nucleus Spatula, Curved, Duck Bill Tips with Notches, Length 122 mm, Round Titanium Handle	82
15-169-23	Kratz Capsule Polisher, 23 Ga x 22 mm, 0.3 mm top port	116
Kuglen Iris Hook		
5-030	Angled, "H" Shaped Tip, Length 122 mm, Round Titanium Handle	71
5-030S	Angled, "H" Shaped Tip, Length 122 mm, Round Handle, Stainless Steel	71
5-030D	Angled, Disposable, 6 per Box	20
5-0301	Straight, "H" Shaped Tip, Length 124 mm, Round Titanium Handle	71
L		
Lacrimal Cannula		
21-R7021	21 Ga x 33 mm, 10 per Box	27
21-R7026	26 Ga x 28 mm, 10 per Box	27
15-027	Reinforced ,Straight, 23 Ga x 32 mm	118
15-029	Reinforced, Curved, 23 Ga x 32 mm	118
Lacrimal Intubation Set		
21-R7001	23 Ga, 30 cm silicone tubing, 3 per Box	27
21-R7004	27 Ga, olive tip, 11 cm probe, 3 per Box	27
21-R7004RD	27 Ga, with Retrieval Device, Olive Tip, 11 cm Probe, Disposable, 3 per Box	27
21-R7002	Lacrimal Intubation Tubing - 30 cm, 3 per Box	27
Lambert		
4-1909T	Chalazion Forceps, Medium, 12.00 mm Diameter, Length 97 mm, Titanium	54
4-1909S	Chalazion Forceps, Medium, 12.00 mm Diameter, Length 97 mm, Stainless Steel	54
4-1908T	Chalazion Forceps, Small, 8.00 mm Diameter, Length 92 mm, Titanium	54
4-1908S	Chalazion Forceps, Small, 8.00 mm Diameter, Length 92 mm, Stainless Steel	54
4-254S	Lambright-Abdullayev Ultrathin DSAEK Grasping/Inserting Forceps, Length 105 mm, Stainless Steel	60

14-045T	Lancaster Eye Speculum, Adjustable Mechanism with Locking Nut, 16.00 mm Solid Blades, Length 70 mm, Titanium	109
LASEK		
20-121	8.00 mm Trephine / 8.50 mm Funnel, Depth of the incision 70 mkm, Length 142 mm, Round Titanium Handle	129
20-122	9.00 mm Trephine / 9.50 mm Funnel, Depth of the incision 70 mkm, Length 142 mm, Round Titanium Handle	129
20-131	Epithelial Micro Hoe, Length 120 mm, Round Titanium Handle	127
20-1031T	Funnel 8.50 mm, Titanium, Length 129 mm	129
20-1041T	Funnel 9.50 mm, Titanium, Length 129 mm	129
20-0011	Knife, Length 128 mm, Round Titanium Handle	127
20-1011	Trephine 8.00 mm, Preset Depth 70 Microns, Length 128 mm, Round Titanium Handle	129
20-1021	Trephine 9.00 mm, Preset Depth 70 Microns, Length 128 mm, Round Titanium Handle	129
LASIK		
4-2206T	Flap Forceps, Curved, Length 108 mm, Titanium	55
3-176T	Flap Marker, 3 Marking Lines, Optical Zone 8.00 mm, Length 130 mm, Titanium	41
21-R7430	Irrigating Cannula (Lindstrom) 25 Ga, angled, 10 per Box	26
20-013	Spatula And Flap Retreatment Instrument, Double-ended, Length 133 mm, Round Titanium Handle	104
3-174T	Lavery Marker, Round Handle, Optical Zone 8.50 mm, Length 130 mm, Titanium	41
4-03742	Lesieur Capsulorhexis Forceps with Internal Ruler, 23 Ga, 7 Engravings, Reduced Length, Gentle Curved Tube, Micro Jaws, Tip Only	52
7-0634/I	Lesieur Hydrochopper, 20 Ga, Round Handle, Length 105 mm, Titanium Handle	84
Lester		
4-0832S	Fixation Forceps, Straight, 2x3 Teeth, Length 105 mm, Stainless Steel	61
5-0331	Lens Manipulator, Angled, 0.20 mm Hourglass Shaped Tip, Length 122 mm, Round Titanium Handle	71
5-0331S	Lens Manipulator, Angled, 0.20 mm Hourglass Shaped Tip, Length 122 mm, Round Handle, Stainless Steel	71
5-033	Lens Manipulator, Straight, 0.20 mm Hourglass Shaped Tip, Length 124 mm, Round Titanium Handle	71
5-0331D	Lens Manipulator, Angled, Disposable, 6 per Box	20
15-065	Lewicky Anterior Chamber Maintainer, 20 Gax3.5 mm Tip	114
5-021	Lewicky Hook, Angled, 0.15 mmx10.00 mm Shaft, Length 120 mm, Round Titanium Handle	71
16-50S	Lid Plate, 20.00 mm and 24.00 mm Wide, Length 110 mm, Stainless Steel	121
16-50T	Lid Plate, 20.00 mm and 24.00 mm Wide, Length 110 mm, Titanium	121
Lieberman		
Nasal Speculum		
14-081LA	with Aspiration, Adult Size, 14.00 mm Rounded Open Blades, Specially Designed for LASIK, Length 75 mm	108
14-0411T	14.00 mm "V" Shaped Blades, Flat Branches, Adult Size, Length 70 mm, Titanium	111
14-0431T	10.00 mm "V" Shaped Blades, Flat Branches, Child Size, Length 60 mm, Titanium	111
14-0411TL	14.00 mm Rounded Open Blades, Flat Branches, Specially Designed For LASIK, Length 70 mm, Titanium	111
14-041T	14.00 mm "V" Shaped Blades, Round Branches, Adult Size, Length 70 mm, Titanium	111
14-043T	10.00 mm "V" Shaped Blades, Round Branches, Child Size, Length 60 mm, Titanium	111
14-041TK	14.00 mm Kratz Style Blades, Round Branches, Length 70 mm, Titanium	111
Temporal Speculum		
14-082A	with Aspiration, Child Size, 10.00 mm "V" Shaped Blades, Length 64 mm	108
14-080A	with Aspiration, Adult Size, 14.00 mm "V" Shaped Blades, Length 78 mm	108
14-0401T	14.00 mm "V" Shaped Blades, Flat Branches, Adult Size, Length 76 mm, Titanium	110
14-0401S	14.00 mm "V" Shaped Blades, Flat Branches, Adult Size, Length 76 mm, Stainless Steel	110
14-0401TK	14.00 mm Kratz Style Blades, Flat Branches, Adult Size, Length 76 mm, Titanium	110
14-0401TL	14.00 mm Rounded Open Blades, Flat Branches, Specially Designed For LASIK, Length 76 mm, Titanium	110
14-040T	14.00 mm "V" Shaped Blades, Round Branches, Adult Size, Length 76 mm, Titanium	110
14-040S	14.00 mm "V" Shaped Blades, Round Branches, Adult Size, Length 76 mm, Stainless Steel	110
14-042T	10.00 mm "V" Shaped Blades, Round Branches, Child Size, Length 60 mm, Titanium	110
14-042S	10.00 mm "V" Shaped Blades, Round Branches, Child Size, Length 60 mm, Stainless Steel	110
14-040TL	14.00 mm Rounded Open Blades, Round Branches, Specially Designed For LASIK, Length 76 mm, Titanium	110
14-040TK	14.00 mm Kratz Style Blades, Round Branches, Adult Size, Length 71 mm, Titanium	110
14-080LA	with Aspiration, Adult Size, 14.00 mm Rounded Open Blades, Specially Designed for LASIK, Length 78 mm	108
20-002	Lindstrom LASIK/PRK Spatula And Epithelium Removal Board, Length 148 mm, Round Titanium Handle	129
12-5186	Loading Forceps, 23/25 Ga, Length 116 mm, Titanium	144
LRI		
2-031T	Gauge, with Atraumatic Fixation Teeth, 13.00/19.00 mm Diameters, Length 134 mm, Titanium	38
3-190T	Axis Marker, Pre-Op Reference Marker, Horizontal Axis 3' and 9', Length 120 mm, Titanium	42

3-1801	Marker, 40-60-80 Degrees, with Degree Gauges, Length 130 mm, Titanium	42
3-183T	Marker, Intra-Op, 30, 45 and 60 Degree Marks, Length 116 mm, Titanium	42
3-191	Slit Lamp Gravity Marker, Pre-Op, 14.00 mm, Horizontal Axis 3' and 9', Length 138 mm, Round Titanium Handle, Stainless Steel Gravity System	42
3-192	Lum Gravity Axis Marker, Pre-Op, 14.00 mm, Angled, Horizontal Axis 3' and 9', Length 140 mm, Round Titanium Handle, Stainless Steel Gravity System	42
12-3044	Lucke Multipurpose Forceps, 20 Ga, Tip Only	138
M		
4-2113S	MacDonald Style Inserting Forceps, Cross Action, Length 107 mm, Stainless Steel	62
16-020T	Maloney Intraoperative Keratometer, Length 23 mm, Titanium	37
13-160	Manipulator for DLEK Procedure, Z-hook with Blunt Tip, Length 120 mm, Round Titanium Handle	103
20-050	Marking Pen, double-ended, Disposable, 10 per Box	129
15-061-26	McIntyre Anterior Chamber Maintainer Angled, 26 Ga	114
Nucleus Hydrodissector		
15-071-23	Spatulated, 23 Ga x 22 mm	115
15-071-25	Spatulated, 25 Ga x 22 mm	115
15-071-27	Spatulated, 27 Ga x 22 mm	115
15-079L	McIntyre-Binkhorst Cannula, 26 Ga, Left	116
McPherson Tying Forceps		
Angled		
4-175T	10.00 mm Tying Platform, Length 104 mm, Titanium	69
4-175S	10.00 mm Tying Platform, Length 104 mm, Stainless Steel	69
4-176T	12.00 mm Tying Platform, Length 106 mm, Titanium	69
4-173T	6.00 mm Tying Platform, Length 102 mm, Titanium	69
4-173S	6.00 mm Tying Platform, Length 102 mm, Stainless Steel	69
4-174T	8.00 mm Tying Platform, Length 103 mm, Titanium	69
4-174S	8.00 mm Tying Platform, Length 103 mm, Stainless Steel	69
4-174D	Disposable, Angled, 6 per Box	21
Curved		
4-177S	4.00 mm Tying Platform, Length 109 mm, Stainless Steel	69
4-177T	4.00 mm Tying Platforms, Length 109 mm, Titanium	69
4-177D	Disposable, 6 per Box	21
Straight		
4-171S	4.00 mm Tying Platform, Length 84 mm, Stainless Steel	69
4-171T	4.00 mm Tying Platform, Length 84 mm, Titanium	69
4-178S	7.00 mm Tying Platform, Length 110 mm, Stainless Steel	69
11-062S	McPherson-Vannas Curved Iris Scissors, Sharp Tips, 8.00 mm Blades, Round Handle, Length 85 mm, Stainless Steel	93
13-154T	Melles DSAEK PLK Scraper, Style 1, 45° Angle, Length 125 mm, Titanium	101
13-155T	Melles DSAEK PLK Scraper, Style 2, 90° Angle, Length 125 mm, Titanium	101
13-092	Membrane Scratcher, 20 Ga	140
Mendez Degree Gauge		
2-030T	Round Handle, Length 134 mm, Titanium	38
2-030S	Round Handle, Length 134 mm, Stainless Steel	38
2-034T	with 4 Grooves, 12.00/14.00 mm Diameters, Length 120 mm, Titanium	38
2-0331T	with 4 Grooves, 13.00/16.50 mm Diameters, Length 122 mm, Titanium	38
2-0331S	with 4 Grooves, 13.00/16.50 mm Diameters, Length 122 mm, Stainless Steel	38
2-033T	with 4 Grooves, 13.00/18.00 mm Diameters, Length 136 mm, Titanium	38
Meyerhoefer Chalazion Curette		
16-063	Size 0-1.50 mm, Length 135 mm, Round Titanium Handle	122
16-063S	Size 0-1.50 mm, Length 135 mm, Round Handle, Stainless Steel	122
16-064	Size 1-1.75 mm, Length 135 mm, Round Titanium Handle	122
16-064S	Size 1-1.75 mm, Length 135 mm, Round Handle, Stainless Steel	122
16-065	Size 2-2.00 mm, Length 135 mm, Round Titanium Handle	122
16-065S	Size 2-2.00 mm, Length 135 mm, Round Handle, Stainless Steel	122
16-066	Size 3-2.50 mm, Length 135 mm, Round Titanium Handle	122
16-066S	Size 3-2.50 mm, Length 135 mm, Round Handle, Stainless Steel	122
16-067	Size 4, 3.50 mm, Length 135 mm, Round Titanium Handle	122
16-067S	Size 4, 3.50 mm, Length 135 mm, Round Handle, Stainless Steel	122
4-0505T	Micro Colibri Corneal Forceps, 0.12 mm, 1x2 Teeth, Flat Handle, Length 73 mm, Titanium	57
7-097	Micro Finger Chopper, Round Handle, Length 120 mm, Round Titanium Handle	81
4-2173	Micro Foldable Lens Cutter, Straight Scissors, Blades with Notches, 19 Ga	97

16-0111	Micro Trabeculectomy Punch, 0.70 mm Diameter, 0.30 mm x 0.60 mm Deep Bite, 20 Ga, Tip Only	122
4-0312S	Microcoaxial Capsulorhexis Forceps, Ultra Thin, 11.50 mm Curved Jaws, For 2.00 mm Incision, with Alignment Mechanism, Length 106 mm, Stainless Steel	48
15-170	Microincisional Capsule Polisher Cannula, Disc-shaped, 23 Ga	116
4-032S	Small-incision Capsulorhexis Forceps with Limiter, Cystotome Tips, Curved Micro-Thin Jaws, Fits through 2.00 mm incision, Flat Handle, Length 105 mm, Stainless steel	49
7-1271	Chang Chopper, Double Ended, LHD, Length 125 mm, Round Titanium Handle	82
7-127	Chang Chopper, Double Ended, RHD, Length 125 mm, Round Titanium Handle	82
4-2303T	Moorsfield Suturing Forceps, Grooved section 14.00 mm, Flat Handle, Length 110 mm, Titanium	68
N		
Nagahara		
7-0631	Phaco Chopper & Drysdale Nucleus Manipulator, Double Ended, Length 128 mm, Round Titanium Handle	82
7-0631S	Phaco Chopper & Drysdale Nucleus Manipulator, Double Ended, Length 128 mm, Stainless Steel	82
7-064	Phaco Chopper, LHD, Dull Finish, Length 120 mm	80
7-063	Phaco Chopper, RHD, Dull Finish, Length 120 mm	80
7-063S	Phaco Chopper, RHD, Dull Finish, Length 120 mm, Stainless Steel	80
7-063D	Phaco Chopper, RHD, Disposable, 6 per Box	20
7-145	Nagy Femtosecond Chopper, Length 122 mm, Round Titanium Handle	83
16-127	Nasal Speculum, Adult Size, Polished finish, Length 150 mm, Stainless Steel	123
4-0352T	Nevyas Capsulorhexis Forceps, Cystotome Triangular Claw-Shaped Tips, 11.50 mm Straight Jaws, Flat Handle, Length 105 mm, Titanium	47
4-08011T	Nevyas-Wallace Fixation Forceps, 0.12 mm, 1x2 Teeth, Straight, Round Handle, Length 105 mm, Titanium	61
7-072	Nucleus Claw Chopper, Angled, Round Handle, Length 120 mm	80
O		
13-1081-23	Ogura PVD Spatula, 23 Ga	140
3-034	Optical Zone Marker, ICSR Set, Double Ended, 0.15/0.5 mm	41
Osher		
4-2175S	IOL Scissors, To Cut Silicone Or Acrylic IOL, 8.50 mm Blades, Length 91 mm, Stainless Steel	97
4-136S	Superior Rectus Forceps, Curved with 1x2 teeth, 0.50 mm, Angled Shafts, 10 mm from Tip to Angle, Length 106 mm, Stainless Steel	68
11-013S	Universal Corneal Scissors, Blunt Tips, Gently Curved, 21.00 mm Blades, Length 120 mm, Stainless Steel	92
3-0304T	Osher-Neuman Low Profile Corneal Marker, 8 Lines, Length 130 mm, Titanium	40
OVDs		
SmartVisc	1.00 ml Sodium Hyaluronate 1.6%; One Single-Use Injection Cannula, Luer-Lock, 27 Ga	17
SmartVisc PLUS	1.00 ml Sodium Hyaluronate 3.0%; One Single-Use Injection Cannula, Luer-Lock, 23 Ga	17
Supreme	2.00 ml Hydroxypropyl Methylcellulose 2%; One Single-Use Injection Cannula	16
P		
13-141	Pallikaris ICL Manipulator, Sandblasted tip, Length 123 mm, Round Titanium Handle	107
13-110	Paton Spatula And Spoon, Double Ended, Length 150 mm, Round Titanium Handle	99
4-0606T	Paufique Suturing Forceps, 0.50 mm, 1x2 Teeth, 6.00 mm Tying Platform, Flat Handle, Length 87 mm, Titanium	68
4-0606S	Paufique Suturing Forceps, 0.50 mm, 1x2 Teeth, 6.00 mm Tying Platform, Flat Handle, Length 87 mm, Stainless Steel	68
15-073-27	Pearce J-Shaped Micro Hydrodissector 27 Ga x 22 mm	115
7-0681	Phaco Chopper for Cross-Chop Technique, Length 120 mm, Round Titanium Handle	81
7-069	Phaco Cleaver, LHD, Angled, Length 120 mm, Round Titanium Handle	80
7-068	Phaco Cleaver, RHD, Angled, Length 120 mm, Round Titanium Handle	80
7-125	Phaconit Quick Chopper, 0.18 mm Wide Tip, Angled, Length 120 mm, Round Titanium Handle	81
Pick Vitreoretinal Forceps		
12-325	Reusable, 20 Ga, Tip Only	139
12-325-23	Reusable, 23 Ga, Tip Only	139
12-325-23H	Reusable, 23 Ga, Attached to a Universal Handle, with RUMEX Flushing System	143
12-3259	Reusable, 25 Ga, Tip Only	142
12-325-25H	Reusable, 25 Ga, Attached to a Universal Handle, with RUMEX Flushing System	143
12-325-23D	Disposable, 23 Ga, Stainless Steel, 6 per Box	145
12-325-25D	Disposable, 25 Ga, Stainless Steel, 6 per Box	145
9-031	Pigtail Lacrimal Probe, 8.00 mm Probes with Holes, Polished Tip, Length 125 mm, Round Titanium Serrated Handle	89
9-031S	Pigtail Lacrimal Probe, 8.00 mm Probes with Holes, Polished Tip, Length 125 mm, Round Serrated Handle, Stainless Steel	89
R2-40405	PVA Spears, pack of 10/box: 180	22

Sterilizing Tray		
Aluminum		
18-319	w/silicone mat, 155×65×20 mm	126
18-320	w/silicone mat, 155×65×40 mm	126
18-321	w/silicone mat, 200×65×20 mm	126
18-322	w/silicone mat, 200×110×20 mm	126
18-323	w/silicone mat, 200×110×40 mm	126
18-324	w/silicone mat, 260×160×20 mm	126
18-325	w/silicone mat, 260×160×40 mm	126
18-326	w/silicone mat, Double level, 260×160×40 mm	126
18-327	w/silicone mat, Double level, 260×160×80 mm	126
18-328	w/silicone mat, 260×160×80 mm	126
18-331	w/silicone mat, 215×165×20 mm,	126
18-332	w/silicone mat, 310×235×20 mm	126
18-333	w/silicone mat, Double Level + Open Section, 375×220×45 mm	126
18-334	w/silicone mat, 390×265×20 mm	126
18-335	w/silicone mat, 390×265×40 mm	126
18-336	w/silicone mat, Double level, 390×265×40 mm	126
Plastic		
18-300	w/2 silicone plug-in inserts, 190×101×38 mm	125
18-301-1	w/2 silicone plug-in inserts, 152×63.5×19 mm	125
18-305-1	w/2 silicone plug-in inserts, 254×152.4×38 mm	125
18-303-1	w/2 silicone plug-in inserts, 190×101×19 mm	125
18-300-1	w/silicone mat, 190×101×38 mm	125
18-301	w/silicone mat, 152×63.5×19 mm	125
18-302	w/silicone mat, 165×101×19 mm	125
18-303	w/silicone mat, 190×101×19 mm	125
18-304	w/silicone mat, 254×152×19 mm	125
18-305	w/silicone mat, Double level, 254×152.4×38 mm	125
18-307	w/silicone mat, 68.5×38×25.5 mm	125
18-308	w/silicone mat, 190.5×63.5×19 mm	125
18-318	Stainless Steel Tray with Silicone Mat, Double Level, 240x240x60 mm	126
4-0814T	Pollack Corneal Transplantation Fixation Forceps, Curved, Round Handle, Length 112 mm, Titanium	61
7-111S	Prechopper Angled, Cross Action, Max opening 2.80 mm, Round Handle, Length 116 mm, Stainless Steel	79
4-140T	Putterman Type Lid Clamp, Length 100 mm, Titanium	54
Q		
7-1281	Quick Chopper with Rounded Edge, LHD, Round Handle, 120 mm	81
7-128	Quick Chopper with Rounded Edge, RHD, Round Handle, 120 mm	81
Quickert Lacrimal Intubation Probe		
9-021S	Size 0, Length 140 mm, Stainless Steel	89
9-023S	Size 2, Length 140 mm, Stainless Steel	89
R		
SMILE		
20-2071	Double Lenticule Spatula (Blunt Spoon and Shortened Flat Spatula), Length 139 mm, Round Titanium Handle	105
4-0398	Cross-Action Forceps, Length 120 mm	56
4-266S	Lenticule Extraction Forceps with a View-Port, Length 106 mm, Stainless Steel	56
4-268S	Lenticule Extraction Forceps with Serrations, Length 84 mm, Stainless Steel	56
20-2073	Lenticule Removing Spatula, Overall Length 120 mm, Round Titanium Handle	105
20-207	Stodulka Double Lenticule Spatula (Blunt Spoon And Flat Spatula), Length 140 mm, Round Titanium Handle	105
Reservoir		
12-5147	for Backflush Instrument, Passive, 5 per Box	148
12-5159	for Backflush Instrument, Aktive, 5 per Box	148
21-R1125	Retrobulbar Needle-Atkinson 25 Ga x 38 mm, 10 per Box	25
3-196	Richman Toric Marker, Angled shaft	44
Rosen		
7-065	Phaco Chopper Universal, Angled, Length 120 mm, Round Titanium Handle	80
7-065S	Phaco Chopper Universal, Angled, Length 120 mm, Round Handle, Stainless Steel	80
7-067	Phaco Splitter, LHD, Wedge Shaped, 60° Angled, Length 120 mm	80
7-066	Phaco Splitter, RHD, Wedge Shaped, 60° Angled, Length 120 mm	80
7-065D	Phaco Chopper, Universal, Disposable, 6 per Box	20

Rowen Rescue Kit For Lens Removal		
4-2150	Crocodile Type Forceps, 20 Ga, Tip Only	63
4-2151	Straight Scissors, 18 Ga, Tip Only	63
RUMEX		
16-010	Corneoscleral Punch (0.50, 0.75, 1.00, 1.50 mm Tips), Length 110 mm, Titanium Handle	122
4-21731	Foldable Lens Cutter, Length 113 mm, Squeeze Titanium Handle	64
2-062S	Internal Micro Incision Gauges, 16 Blades 1.00 - 2.50 mm, Length 75 mm, Stainless Steel	37
5-031	Lens Manipulator, Button Shaped Tip 0.45 mm, Angled, Length 122 mm, Round Titanium Handle	71
3-1941	Toric Combo Marker, Horizontal 0-0 Axis, Length 125 mm, Round Titanium Handle, Stainless Steel Gravity System	43
3-194	Toric Combo Marker, Vertical 0-0 Axis, Length 125 mm, Round Titanium Handle, Stainless Steel Gravity System	43
5-046	Rychwalski Muscle Hook, 12.00 mm Hook with Groove, Length 140 mm, Flat Titanium Handle	73
Rycroft Anterior Chamber Cannula		
15-051-23	23 Ga x 22 mm, 4 mm bend length 122	113
15-051-25	25 Ga x 22 mm, 4 mm bend length 122	113
15-051-27	27 Ga x 22 mm, 4 mm bend length 122	113
15-052-27	27 Ga x 22 mm, 6 mm bend length 122	113
15-053-27	27 Ga x 22 mm, 8 mm bend length 122	113
15-051-30	30 Ga x 22 mm, 4 mm bend length 122	113
S		
Sandblasted		
12-301	End-Gripping Vitreoretinal Forceps, 20 Ga, Tip Only	138
12-301-23	End-Gripping Vitreoretinal Forceps, 23 Ga, Tip Only	138
12-3019	Straight Gripping Vitreoretinal Forceps, 25 Ga, Tip Only	138
12-301-23D	Gripping Forceps with Sandblasted Platform, 23 Ga, Disposable, 6 per Box	145
12-301-25D	Gripping Forceps with Sandblasted Platform, 25 Ga, Disposable, 6 per Box	145
12-301-23H	Gripping Forceps, 23 Ga, Attached to a Universal Handle, with RUMEX Flushing System	143
12-301-25H	Gripping Forceps, 25 Ga, Attached to a Universal Handle, with RUMEX Flushing System	143
Sapphire Knife		
Clear Corneal Blade		
6-20/6SK-075	60°, 2.20 mm	77
6-20/6SK-080	60°, 2.65 mm	77
6-20/6SK-072	60°, 2.80 mm	77
6-20/6SK-093	Crescent Blade 2.20 mm	77
Double Edge Blade		
6-10/6SK-0501	45°, 1.00 mm	77
6-10/6SK-070	Lancet, 60°, 1.00 mm	77
Trapezoid Blade		
6-20/6SK-145	1.80 - 2.20 mm	77
6-20/6SK-146	1.80 - 2.40 mm	77
6-20/6SK-147	1.80 - 2.90 mm	77
6-10/6SK-053	Trifacet Blade, 1.00 mm	77
6-20/6SK-0551	Zaldivar ICL Blade, 0.55 - 1.00 mm	77
Sauer Temporal Lid Speculum		
14-030	Child size, Solid 8 mm Blades, Length 35 mm	110
14-031	Newborn, Solid 5 mm Blades, Length 25 mm	110
14-032	Premature, Solid 4 mm Blades, Length 20 mm	110
16-080S	Schaedel Towel Clamp, Flat handle, Length 85 mm, Stainless Steel	70
16-111S	Schocket Double Ended Scleral Depressor, with pocket clip, Length 143 mm, Stainless Steel	122
16-111	Schocket Double Ended Scleral Depressor, with pocket clip, Length 143 mm, Round Titanium Handle	122
11-0381S	Scissors For DALK Procedure, Left, Length 106 mm, Stainless Steel	92
11-038S	Scissors For DALK Procedure, Right, Length 106 mm, Stainless Steel	92
12-5086S	Scleral Plugs Forceps, Length 106 mm, Stainless Steel	144
5-061	Scobee Oblique Muscle Hook, Curved, Flat 4.50 mm Hook, Length 136 mm, Flat Titanium Handle	73
5-061S	Scobee Oblique Muscle Hook, Curved, Flat 4.50 mm Hook, Length 136 mm, Flat Handle, Stainless Steel	73
7-130	Seibel Chopper, Ball-Shaped Tip, Length 122 mm, Round Titanium Handle	81
7-1361	Seibel Chopper/Quick Chopper with Rounded Edge, RHD, Length 132 mm, Round Titanium Handle	82
12-5165	Self-Retaining Silicone Oil Cannula, Disposable, 23 Ga	151
16-090S	Serrefine, Straight, Large Size, Length 55 mm, Stainless Steel	67

15-032	Shahinian Lacrimal Cannula, 25 Ga x 35 mm	118
15-203	Sheets Irrigating Vectis, 21 Ga x 38 mm, 3 irrigating ports	115
11-0481S	Shepard-Westcott Curved Tenotomy Scissors, Blunt Tips, 21.00 mm Blades, Length 123 mm, Stainless Steel	95
10-030S	Schepens Orbital Retractor, Length 144 mm, Stainless Steel	90
11-03741	Side-Port Capsulotomy Scissors, Left, 20 Ga, with Lock, Tip Only	96
11-03751	Side-Port Capsulotomy Scissors, Right, 20 Ga, Tip Only	96
15-301/303	Silicone Bulb with Adapter	118
Silicone Oil		
SmartSil1000	1000 cSt, 10 ml in a 20 ml syringe	150
SmartSil5000	5000 cSt, 10 ml in a 20 ml syringe	150
Silicone Oil Injection System		
12-RTUB-4	Reusable Tubing System Adjustable to Oerliti® Orbit™, Faros™, OS3™	151
12-RTUB-3	Reusable Tubing System Adjustable to B&L® Millenium™, Stellaris™	151
12-RTUB-2	Reusable Tubing System Adjustable to DORC® Associate; Alcon® Constellation™	151
12-RTUB-1	Reusable Tubing System Adjustable to Loltech® Pentasys; Optikon® Antares; Alcon® STTO; Storz® Premiere	151
Simcoe		
15-091-13/23	Cortex Extractor Cannula, 23 Ga x 13 mm	116
15-129-0.4	I/A Cannula, 23/22 Ga, 0.4 mm Port, Regular	114
15-129-0.3	I/A Cannula, 23/23 Ga, 0.3 mm Port, Regular	114
7-080/SIM	I/A Tip	85
15-133-0.4	Reverse I/A Cannula, 23/22 Ga, Asp 0.4 mm Port, Irr. Through Tubing	114
15-133-0.3	Reverse I/A Cannula, 23/23 Ga, Asp 0.3 mm Port, Irr. Through Tubing	114
Sinsky Hook		
5-032	Angled, 0.15 mm x 10.00 mm Shaft, Length 122 mm, Round Titanium Handle	71
5-032S	Angled, 0.15 mm x 10.00 mm Shaft, Length 122 mm, Round Handle, Stainless Steel	71
5-0321	Straight, 0.15 mm, Round Handle, Length 122 mm, Round Titanium Handle	71
5-0322	Reversed, Angled, 0.20 mm x 10.00 mm Shaft, Length 117 mm, Round Titanium Handle	71
5-032D	Disposable, Angled, 6 per Box	20
15-376	Slade LASIK Cannula, 26 Ga	117
14-052T	Slade- Murdoch Speculum, Temporal, Parallel Retraction Design, 14.00 mm Open Blades, Length 54 mm	110
7-143	Slade/Terao Nucleus Splitter, 23 Ga, Tip Only	83
Soft Tip Cannula		
12-5161	23 Ga, 5 per Box	149
12-5152	25 Ga, 5 per Box	149
12-5491	27 Ga, 5 per Box	149
Spatula		
13-171	for DALK Procedure, 1.00 x 9.00 mm Tip, Length 122 mm, Round Titanium Handle	103
20-204	for Femtosecond Laser Procedure, Length 120 mm, Round Titanium Handle	99
20-204D	for Femtosecond Laser Procedure, Disposable, 6 per Box	20
13-020	Curved, 0.25 mm Wide, 12.00 mm Long, Length 122 mm, Round Titanium Handle	98
13-010	Straight, 0.25 mm Wide, 10.00 mm Long Tip, Length 122 mm, Round Titanium Handle	98
13-011	Straight, 0.40 mm Wide, 14.00 mm Long, Length 122 mm, Round Titanium Handle	98
13-011S	Straight, 0.40 mm Wide, 14.00 mm Long, Length 122 mm, Round Handle, Stainless Steel	98
13-014	Straight, 1.00 mm Wide, 13.00 mm Long, Length 122 mm, Round Titanium Handle	98
13-014S	Straight, 1.00 mm Wide, 13.00 mm Long, Length 122 mm, Round Handle, Stainless Steel	98
13-150T	Spatula-Guide For Corneal Endothelium Implantation, Length 122 mm, Titanium	100
12-321	Spring Gripping Vitreoretinal Forceps, 20 Ga, Tip Only	139
12-321-23	Spring Gripping Vitreoretinal Forceps, 23 Ga, Tip Only	139
4-2107T	Steinert Paddle Lens Folding Forceps, Angled Shafts, Flat Handle, Length 110 mm, Titanium	62
4-2107S	Steinert Paddle Lens Folding Forceps, Angled Shafts, Flat Handle, Length 110 mm, Stainless Steel	62
Stevens		
5-062	Curved Tenotomy Hook, 6.00 mm Flat Hook, Length 120 mm, Flat Titanium Handle	73
5-062S	Curved Tenotomy Hook, 6.00 mm Flat Hook, Length 120 mm, Flat Handle, Stainless Steel	73
Tenotomy Scissors		
11-132S	Curved, Blunt Tips, Length 115 mm, Stainless Steel	95
11-131S	Curved, Sharp Tips, Length 115 mm, Stainless Steel	95
11-133S	Straight, Blunt Tips, Length 115 mm, Stainless Steel	95
11-130S	Straight, Sharp Tips, Length 115 mm, Stainless Steel	95
10-013	Lacrimal Sac Retractor, Curved, 2x3 mm Teeth, Length 83 mm	90
10-013S	Lacrimal Sac Retractor, Curved, 2x3 mm Teeth, Length 83 mm, Stainless Steel	90
Stodulka		

7-0811	Enhanced Irrigation Handpiece, Curved, 21 Ga	85
4-2012S	Forceps For Small-Incision Lenticule Extraction (ReLEx SMILE), Angled, Flat Handle, Length 100 mm, Stainless Steel	56
20-207	ReLEx Smile Double Lenticule Spatula (Blunt Spoon And Flat Spatula), Length 140 mm, Round Titanium Handle	105
12-335	Stolyarenko Forceps For Large Foreign Body, 20 Ga, Tip Only	139
12-211	Straight Vitreoretinal Scissors, Rounded Blades, 20 Ga, Tip Only	136
13-146	Suarez Spreader, ICSR Set, 1x6x1.25 mm, Straight	107
Sub-Tenon's Anesthesia Cannula		
15-009	(Para), Curved, 19 Ga x 25 mm, 0.30 mm Side Port	113
21-R1320	20 Ga x 1 in (90x25 mm), 10 per Box	25
15-011C-19	Curved, 19 Ga x 25 mm, 3 ports	113
15-013-19	Curved, Flattened Tip, 19 Ga x 25 mm, Front Opening	113
16-137	Surgical Chisel, 3.00 mm, Stainless Steel	123
16-135	Surgical Mallet, Polished Finish, Stainless Steel	123
Sutures		
22-R1404	10-0 Nylon 30cm, Needle: Trape Spatula 5.5 mm 7/16 Curve	23
22-R1404S	10-0 Nylon 15cm, Needle: Trape Spatula 5.5 mm 7/16 Curve	23
22-R1410	10-0 Nylon 30cm, Needle: Trape Spatula 7.0 mm 1/2 Curve	23
22-R2002	10-0 Nylon 30cm, Needle: Trape Spatula 6.5 mm 3/8 Curve	23
22-R2090	8-0 Polyglycolic Acid 30cm, Needle: Trape Spatula 6.5 mm 3/8 Curve	23
22-R2801	6-0 Silk 45cm, Needle: Trape Spatula 6.5 mm 3/8 Curve	23
22-R3305	6-0 Silk 45cm, Needle: Reverse Cut 11.0 mm 3/8 Curve	23
22-R3373	5-0 Polyester 45cm, Needle: Dia Spatula 8.0 mm 1/4 Curve	23
22-R3377	5-0 Polyester 45cm, Needle: Trape Spatula 8.0 mm 1/4 Curve	23
T		
13-185	Tan Marginal DMEK Dissector, Length 132 mm, Round Titanium Handle	102
12-414	Tanaka Maculorhexis Forceps, 23 Ga, Tip Only	137
Tennant Tying Forceps		
4-1851T	Angled, Extra Delicate Tips, For 9-0 to 11-0 Sutures, Round Handle, Titanium	70
4-186S	Curved, Extra Delicate Tips, For 9-0 To 11-0 Sutures, Round Handle, Length 107 mm, Stainless Steel	70
4-185S	Straight, Extra Delicate Tips, For 9-0 to 11-0 Sutures, Round Handle, Length 108 mm, Stainless Steel	70
4-185T	Straight, Extra Delicate Tips, For 9-0 to 11-0 Sutures, Round Handle, Length 108 mm, Titanium	70
16-139	Tenzel Double Ended Periosteal Elevator, Length 195 mm, Round Titanium Handle	123
13-153S	Terry DSEK Scraper, Angled shaft, 11.00 mm from Tip to Angle, Hole-shaped Scraper Facing Upward, Length 112 mm, Stainless Steel	101
3-181	Toric IOL Marker, Intra-Op, Length 130 mm, Titanium	41
16-081S	Towel Forceps, Ring handle, Length 90 mm, Stainless Steel	70
7-126S	Triple Edge Chopper with Polisher Tip, Round Handle, Length 117 mm, Stainless Steel	82
7-126	Triple Edge Phaco Chopper with Polisher Tip	82
13-170	Trisector for DALK Procedure, 1.4x0.7 mm Tip, Length 124 mm	103
Trocar System		
12-5173-23	Two Step, Reusable, 23 Ga	144
12-5173-25	Two Step, Reusable, 25 Ga	144
12-5229	One Step, Disposable, 23 Ga, 6 per Box	147
12-5244	One Step, Disposable, 25 Ga, 6 per Box	147
12-5227	One Step, Disposable, 27 Ga, 6 per Box	147
16-173S	Tunnel Maker, 4.40/5.60 mm Diameter, 0.30 mm Width, Left, Stainless Steel	123
16-174S	Tunnel Maker, 4.40/5.60 mm Diameter, 0.30 mm Width, Right, Stainless Steel	123
3-143T	Tunnel Zone Marker, 4.00/6.00 mm Diameter, 40° Angled to Handle, Length 127 mm, Titanium	41
U		
7-0751	Universal Multifunctional Phaco Chopper, Length 120 mm, Round Titanium Handle	80
Utrata Capsulorhexis Forceps		
Cystotome Tips		
4-0300S	11.50 mm Straight Jaws, Flat Handle, Length 82 mm, Stainless Steel	47
4-0300T	11.50 mm Straight Jaws, Flat Handle, Length 82 mm, Titanium	47
4-0301T	11.50 mm Straight Jaws, Long Flat Handle, Length 107 mm, Titanium	47
4-0311T	11.50 mm Straight Jaws, Round Handle, Length 110 mm, Titanium	48
4-0311S	11.50 mm Straight Jaws, Round Handle, Length 110 mm, Stainless Steel	48
4-0301S	11.50 mm Straight Jaws, Long Flat Handle, Length 107 mm, Stainless Steel	47
4-0321S	11.50 mm Curved Jaws, Flat Handle, Length 107 mm, Stainless Steel	47
4-0321T	11.50 mm Curved Jaws, Flat Handle, Length 107 mm, Titanium	47
4-0331T	11.50 mm Curved Jaws, Round Handle, Length 110 mm, Titanium	48

4-0331S	11.50 mm Curved Jaws, Round Handle, Length 110 mm, Stainless Steel	48
4-0331D	Curved, Disposable, 6 per Box	21
4-0311D	Straight, Disposable, 6 per Box	21
Regular Tips		
4-030T	11.50 mm Straight Jaws, Flat Handle, Length 82 mm, Titanium	47
4-031T	11.50 mm Straight Jaws, Round Handle, Length 110 mm, Titanium	48
with SCALE		
4-03315T	6 Engravings, 1.00 mm, Cystotome Tips, 11.50 mm Curved Jaws, Round Handle, Length 110 mm, Titanium	48
4-03315S	6 Engravings, 1.00 mm, Cystotome Tips, 11.50 mm Curved Jaws, Round Handle, Stainless Steel	48
4-03115T	6 Engravings, 1.00 mm, Cystotome Tips, 11.50 mm Straight Jaws, Round Handle, Length 110 mm, Titanium	48
4-03115S	6 Engravings, 1.00 mm, Cystotome Tips, 11.50 mm Straight Jaws, Round Handle, Length 110 mm, Stainless Steel	48
4-03314T	2 Engravings at 3.00, 6.00 mm, Cystotome Tips, 11.50 mm Curved Jaws, Round Handle, Length 110 mm, Titanium	48
4-03114T	2 Engravings at 3.00, 6.00 mm, Cystotome Tips, 11.50 mm Straight jaws, Round Handle, Length 110 mm, Titanium	48
4-03314S	2 Engravings at 3.00, 6.00 mm, Cystotome Tips, 11.50 mm Curved Jaws, Round Handle, Length 110 mm, Stainless Steel	48
13-181	Uy Laser Lens Fragmentation Combo Manipulator, Length 131 mm, Round Titanium Handle	99
V		
Vannas Capsulotomy Scissors		
11-054S	Angled, Sharp Tips, 6.00 mm Blades, Flat Handle, Length 81 mm, Stainless Steel	96
11-052S	Curved, Sharp Tips, 6.00 mm Blades, Flat Handle, Length 84 mm, Stainless Steel	96
11-050S	Straight, Sharp Tips, 6.00 mm Blades, Flat Handle, Length 84 mm, Stainless Steel	96
11-052D	Curved, Sharp Tips, Disposable, 6 per Box	21
3-195	Velasquez Gravity Corneal Marker For LRI/Toric IOL Implantation, Angled Shaft, 4 Radial Blades For Horizontal And Vertical Axes Marking, Internal Ring Diameter 5 mm, Length 164 mm, Titanium Handle, Stainless Steel Gravity System	43
15-371-25	Vidaauri LASIK Double Cannula, 25 Ga, 16 Ga x 12 mm shaft, 8 ports	117
15-1051-30	Viscocanalostomy Cannula, 30 Ga, 5 mm Beveled Tip	117
Viscoelastic Cannula		
21-R2225	Angled 9 mm 25 Ga x 22 mm, 10 per Box	25
21-R2227	Angled 9 mm 27 Ga x 22 mm, 10 per Box	25
21-R2327	Angled 10 mm 27 Ga x 22 mm, 10 per Box	25
Viscoelastic Solution set		
SmartVisc	1.00 ml Sodium Hyaluronate 1.6%; One Single-Use Injection Cannula, Luer-Lock, 27 Ga	17
SmartVisc PLUS	1.00 ml Sodium Hyaluronate 3.0%; One Single-Use Injection Cannula, Luer-Lock, 23 Ga	17
Supreme	2.00 ml Hydroxypropyl Methylcellulose 2%; One Single-Use Injection Cannula	16
12-5248	Viscous Fluid Injection Cannula, Disposable, 23 Ga	151
12-5258	Viscous Fluid Injection Cannula, Disposable, 25 Ga	151
12-303	Vitreoretinal Angled Gripping Forceps, 20 Ga, Tip Only	139
12-313	Vitreoretinal Forceps with Cup Jaws, 20 Ga, Tip Only	139
Vitreoretinal Instrument Handle		
12-001T	One Finger Control, Length 108 mm, Titanium	135
12-003T	Squeeze Model, Two Fingers Control, Titanium	135
12-003S	Squeeze Model, Two Fingers Control, Stainless Steel	135
Vitreoretinal Scissors		
Curved		
12-209	Reusable, Curvature Radius 12 mm, 20 Ga, Tip Only	136
12-215	Reusable, Side Curved Vitreoretinal Scissors, 20 Ga, Tip Only	136
12-209-23	Reusable, Curvature Radius 12 mm, 23 Ga, Tip Only	136
12-209-23H	Reusable, Curvature Radius 12 mm, 23 Ga, Attached to a Universal Handle, with RUMEX Flushing System	143
12-2099	Reusable, Curvature Radius 12 mm, 25 Ga, Tip Only	142
12-209-25H	Reusable, 25 Ga, Attached to a Universal Handle, with RUMEX Flushing System	143
12-209-23D	Disposable, 23 Ga, Stainless Steel, 6 per Box	145
12-209-25D	Disposable, 25 Ga, Stainless Steel, 6 per Box	145
12-209-23DP	Disposable, 23 Ga, Plastic Handle 360°, 6 per Box	146
12-209-25DP	Disposable, 25 Ga, Plastic Handle 360°, 6 per Box	146
12-209-27DP	Disposable, 27 Ga, Plastic Handle 360°, 6 per Box	146
Horizontal		

12-206	Reusable, 55°, 20 Ga, Tip Only	136
12-2084	Reusable, 45°, Regular Blades with Illumination, 20 Ga, Tip Only	136
12-2085	Reusable, 45°, Short Blades, 20 Ga, Tip Only	136
	Straight	
12-211-23DP	Disposable, 23 Ga, Plastic Handle 360°, 6 per Box	146
12-211-25DP	Disposable, 25 Ga, Plastic Handle 360°, 6 per Box	146
12-211-27DP	Disposable, 27 Ga, Plastic Handle 360°, 6 per Box	146
Vertical		
12-2029	Reusable, 45°, 25 Ga, Tip Only	136
12-202	Reusable, 70°, 20 Ga, Long Sharp Tips, Tip Only	136
12-202-23	Reusable, 70°, 23 Ga, Long Sharp Tips, Tip Only	136
12-202-23DP	Disposable, 23 Ga, Plastic Handle 360°, Disposable, 6 per Box	146
12-202-25DP	Disposable, 25 Ga, Plastic Handle 360°, Disposable, 6 per Box	146
W		
4-2201T	Watzke Sleeve Spreading Forceps, Angled, Cross-action, Length 110 mm, Titanium	70
16-060	Wells Enucleation Spoon, Round Knurled Handle, Length 145 mm, Round Titanium Handle	123
Westcott		
Curved Tenotomy Scissors		
11-040S	Blunt Tips, 13.00 mm Blades, Flat Handle, Length 115 mm, Stainless Steel	95
11-042S	Blunt Tips, 16.00 mm Blades, Flat Handle, Length 120 mm, Stainless Steel	95
11-048S	Blunt Tips, 19.00 mm Blades, Length 116 mm, Stainless Steel	95
11-040D	Blunt Tips, Disposable, 6 per Box	21
Stitch Scissors		
11-046S	Sharp Tips, Gently Curved 13.00 mm Blades, Flat Handle, Length 115 mm, Stainless Steel	94
11-047S	Sharp Tips, Gently Curved 13.00 mm Blades, Round Handle, Length 115 mm, Stainless Steel	94
11-044S	Sharp Tips, 16.00 mm Blades, Flat Handle, Length 120 mm, Stainless Steel	94
11-125S	Westcott Type Slim Jaws, Gently Curved, Sharp tips, 16.00 mm Blades, Flat Handle, Length 120 mm, Stainless Steel	94
3-040	Whipple Capsulorhexis Centration Marker, 2-Ended, 5.5/6.0 mm	39
Whitehouse Gravity Axis Marker		
3-1932	with Reduced Diameters, Straight, Marks at 3, 6, 9 o'clock, 9.50/12.50 mm, Length 153 mm, Round Titanium Handle, Stainless Steel Gravity System	43
3-193	Angled, Marks At 3, 6, 9 o'clock, 11.00/14.00 mm, Length 153 mm, Round Titanium Handle, Stainless Steel Gravity System	43
3-1931	Straight, Marks at 3, 6, 9 o'clock, 11.00/14.00 mm, Length 152 mm, Titanium Handle, Stainless Steel Gravity System	43
Wilder Lacrimal Dilator		
9-050T	Size 1, 19.00 mm Taper, Length 100 mm, Titanium	89
9-050S	Size 1, 19.00 mm Taper, Length 100 mm, Stainless Steel	89
9-051T	Size 2, 23.00 mm Taper, Length 100 mm, Titanium	89
9-051S	Size 2, 23.00 mm Taper, Length 100 mm, Stainless Steel	89
9-052T	Size 3, 32.00 mm Taper, Length 100 mm, Titanium	89
16-072	Wilder Lens Loop, 4.00 mm Width, Length 134 mm, Round Handle, Titanium	121
16-072S	Wilder Lens Loop, 4.00 mm Width, Length 134 mm, Round Handle, Stainless Steel	121
Y		
7-1166S	Yeoh Femtosecond Prechopper, Straight, Cross-Action, Max opening 2.00 mm, Blunt Atraumatic Tips, Length 120 mm, Stainless Steel	79
Z		
Zaldivar		
20-203	FemtoLASIK Spatula, Length 123 mm, Round Titanium Handle	106
13-142	ICL Manipulator, Length 128 mm, Round Titanium Handle	107
11-03721	Iridectomy Scissors, 23 Ga, with Lock, Tip Only	93
4-21432	Zaldivar - Kraff ICL Pacman Forceps, 20 Ga, Tip Only	65
6-20/6-0551	Zaldivar Diamond Knife for ICL, 0.55/1.00 mm, Length 130 mm, Angled Titanium Handle	75
6-20/6SK-0551	Zaldivar Sapphire Knife for ICL, 0.55/1.00 mm, Length 135 mm, Angled Titanium Handle	77

CERTIFICATES

ISO 13485:2016
ISO 11979-1:2018
ISO 11979 - 2 : 2014
ISO 11979 - 3 : 2012
ISO 11979 - 4 : 2008/Amd 1:2012
EN ISO 15223-1:2021
EN ISO 20417:2021
ISO 11979-5:2020
ISO 11979 - 6 : 2014
ISO 11135:2014/Amd 1:2018
ISO 14155:2020
ISO 11979 - 7 : 2018
ISO 14971:2019
MDD 93/42/EEC
ISO 10993 -1: 2018
ISO 10993-3 :2014
ISO 10993-5 :2009
ISO 10993-6 :2016
ISO 10993-7:2008/Cor 1:2009
ISO 10993-9:2019
ISO 10993-10:2021
ISO 10993-11:2017
ISO 10993-13:2010
ISO 10993-16:2017
ISO 2248:1985
ISO 8655-2:2022
ISO 8655-6:2022
ISO 10012 : 2003
ISO 11607-1:2019/CD AMD 1
EN ISO 13485:2016/AC:2018
ISO 14644 -1: 2015
ISO 14644 - 2:2015
ISO 14644 - 5 : 2004
ISO 11737-1:2018/AMD 1:2021
ISO 11737-2:2019
DIN EN ISO 15798:2022
DIN EN ISO 11607-1:2020
ISO 11979-8:2017
ISO 11979-10:2018
ISO 11138-7:2019

DIN EN ISO 15223-1:2022
BS EN ISO 11737-1:2018+A1:2021"
ISO 11137-1:2006/AMD 2:2018
ISO 11137-2:2013/AMD 1
EN ISO 14971:2019/A11:2021
ISO 15223-1:2021
EN ISO 17664-1:2021
EN 62366-1:2015
ISO 7153-1:2016
ISO 7151:1988
ISO 7741:1986
ISO 14630:2012
DIN EN 556 -1:2002
EN ISO 17664-1:2021
ISO 11607-2:2019/CD AMD 1
BS EN ISO 9000 : 2015
BS EN ISO 19011:2018
BS EN 556 -1: 2001
BS EN ISO 15223 -1:2021
BS EN ISO 10993-1: 2020
ANSI/ASQ Z1.4 : 2008
ISO 17665 -1: 2006
ISO 15798:2022
ISO 9001:2015
NF EN ISO 13485 : 2016
NF EN ISO 17665 -1: 2006
ISO 20857: 2010
NF EN ISO 11737-1: 2018
NF EN ISO 11737 - 2 : 2020
NF EN 556-1:2002
ISO 15223-1:2021
NF EN ISO 14155 : 2020
NF EN ISO 14971: 2022
DIN EN ISO 10993-1:2021
DIN EN ISO 10993-5:2009
DIN EN ISO 10993-12:2021
DIN EN ISO 14971:2022
DIN EN 868-3:2017
DIN EN ISO 13485:2021-12

RUMEX International Company
Head Office: 14240 Carlson Circle,
Building K, Suite 8, Tampa,
FL 33626, USA

USA, Canada:

☎ +1 (727) 535 9600

☎ +1 (877) 77 RUMEX (Toll-Free)

☎ +1 (727) 535 8300

✉ usacs@rumex.com

Europe, Asia, Africa, Latin America:

☎ +371 6616 3182

✉ customerservice@rumex.com

✉ rumex@rumex.com

🏠 www.rumex.com

